

COMPREHENSIVE SERVICES

We offer competitive repair and calibration services, as well as easily accessible documentation and free downloadable resources.

SELL YOUR SURPLUS

We buy new, used, decommissioned, and surplus parts from every NI series. We work out the best solution to suit your individual needs.

 Sell For Cash  Get Credit  Receive a Trade-In Deal

OBSOLETE NI HARDWARE IN STOCK & READY TO SHIP

We stock **New**, **New Surplus**, **Refurbished**, and **Reconditioned** NI Hardware.



Bridging the gap between the manufacturer and your legacy test system.

 1-800-915-6216

 www.apexwaves.com

 sales@apexwaves.com

All trademarks, brands, and brand names are the property of their respective owners.

Request a Quote

 **CLICK HERE**

SCC-PWR01

USER GUIDE

SCC-LP Series Lowpass Filter Modules

The SCC-LP Series lowpass filter modules contain fourth-order Butterworth filter circuitry. They accept two differential input signals within a ± 10 V range. A differential amplifier attenuates each signal by a factor of two. The output of the amplifier passes through a fourth-order Butterworth filter circuit.

The SCC-LP Series consists of the following modules:

- SCC-LP01—25 Hz cutoff frequency
- SCC-LP02—50 Hz cutoff frequency
- SCC-LP03—150 Hz cutoff frequency
- SCC-LP04—1 kHz cutoff frequency

Conventions

The following conventions are used in this guide:

<>

Angle brackets that contain numbers separated by an ellipsis represent a range of values associated with a bit or signal name—for example, P0.<3..0>.

»

The » symbol leads you through nested menu items and dialog box options to a final action. The sequence **File»Page Setup»Options** directs you to pull down the **File** menu, select the **Page Setup** item, and select **Options** from the last dialog box.



This icon denotes a note, which alerts you to important information.



This icon denotes a caution, which advises you of precautions to take to avoid injury, data loss, or a system crash. When this symbol is marked on the product, refer to the *Read Me First: Safety and Radio-Frequency Interference* document, shipped with the product, for precautions to take.



When symbol is marked on a product, it denotes a warning advising you to take precautions to avoid electrical shock.



When symbol is marked on a product, it denotes a component that may be hot. Touching this component may result in bodily injury.

bold

Bold text denotes items that you must select in software, such as menu items and dialog box options. Bold text also denotes parameter names.

italic

Italic text denotes variables, emphasis, a cross reference, or an introduction to a key concept. This font also denotes text that is a placeholder for a word or value that you must supply.

monospace

Text in this font denotes text or characters that you should enter from the keyboard, sections of code, programming examples, and syntax examples. This font is also used for the proper names of disk drives, paths, directories, programs, subprograms, subroutines, device names, functions, operations, variables, filenames, and extensions.

SC-2345

SC-2345 refers to both the SC-2345 connector block and the SC-2345 with configurable connectors.

SCC

SCC refers to any SCC Series signal conditioning module.

SCC-LPXX

SCC-LPXX refers to any SCC-LP Series lowpass filter signal conditioning module.

What You Need to Get Started

To set up and use the SCC-LPXX, you need the following items:

- SC-2345/2350 with one of the following:
 - SCC-PWR01
 - SCC-PWR02 and the PS01 power supply
 - SCC-PWR03—requires a 7 to 42 VDC power supply (not included)
- One or more SCC-LPXX
- SCC-LP Series Lowpass Filter Modules User Guide*
- SC-2345/2350 User Manual*, available at ni.com
- SCC Quick Start Guide*, available at ni.com
- Read Me First: Safety and Radio-Frequency Interference*
- SC-2345 Quick Reference Label
- 68-pin E Series DAQ device, documentation, and 68-pin cable
- 1/8 in. flathead screwdriver
- Numbers 1 and 2 Phillips screwdrivers
- Wire insulation strippers
- NI-DAQ (current version) for Windows 2000/NT/XP/Me



Note Software scaling of measurements is not supported on the Macintosh operating system. Refer to the [Using the SCC-LPXX when Scaling Voltage Measurements](#) section for more information.

Device Specific Information



Note For general SCC module installation and signal connection information, and information about the SC-2350 carrier, refer to the *SCC Quick Start Guide*, available for download at ni.com/manuals.

Installing the Module



Caution Refer to the *Read Me First: Safety and Radio-Frequency Interference* document before removing equipment covers or connecting/disconnecting any signal wires.

You can plug the SCC-LPXX into any analog input socket on the SC-2345. It can function as a single-stage module or as the first or the second stage of a dual-stage signal conditioning configuration. The socket you choose determines which E Series DAQ device channels receive the SCC-LPXX output signals, as explained in the *Connecting the Input Signals* section.

For single-stage conditioning, plug the SCC-LPXX into any socket J(X+1), where X is 0 to 7, and connect the input signals to the module as described in the *Connecting the Input Signals* section.

The SCC-LPXX can function as either the first or the second stage of a dual-stage configuration. Plug the first-stage SCC into any socket J(X+9) and plug the second-stage SCC into socket J(X+1), where X is 0 to 7. Connect the input signals to the first-stage SCC. The SC-2345 connects the output signals of the first-stage SCC to the inputs of the second-stage SCC. An example of dual-stage conditioning is an SCC-A10 voltage attenuator module followed by an SCC-LPXX.

Sockets J9 to J16 also are available for digital input/output (DIO) conditioning or control. Refer to the *SC-2345 User Manual* and *SCC Quick Start Guide* for more information on configuring, connecting, and installing SCC modules.

Connecting the Input Signals



Note The signal names have changed. Refer to ni.com/info and enter `rdntng` to confirm the signal names.

Each screw terminal is labeled by pin number <1..4>. Pins 1 and 2 form a differential channel routed to E Series DAQ device channel X+8, and pins 3 and 4 form a second differential channel routed to E Series DAQ device channel X, where X is 0 to 7 depending on the socket where you plug in the SCC-LPXX.

The signal source can be floating or ground-referenced. The SCC-LPXX input circuitry includes high-impedance bias resistors typically required for floating sources. Therefore, floating signal sources do not require external bias resistors connected to ground.



Note For floating signal sources in high-noise environments, connect the negative terminal of the signal source to the AI GND terminal on the SC-2345 screw-terminal block to reduce common-mode noise.

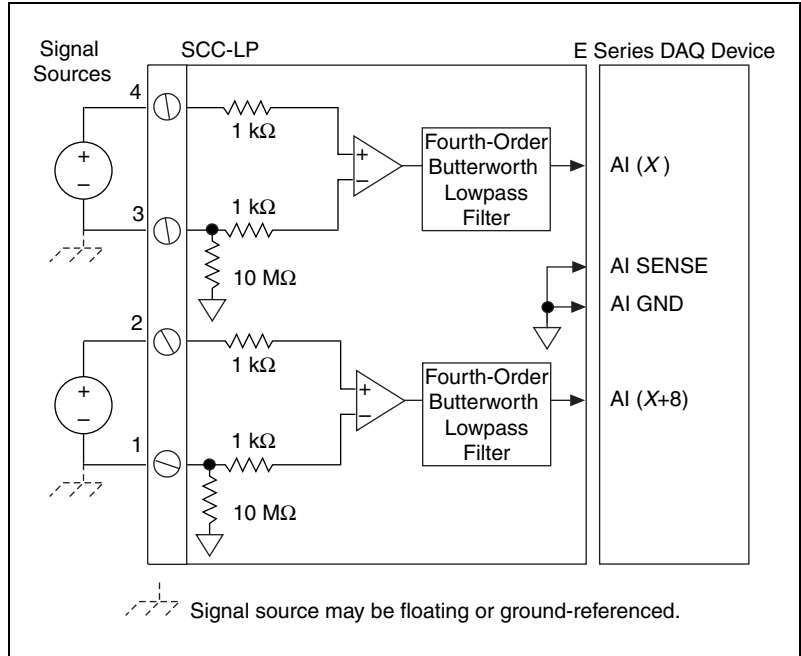

Figure 1. SCC-LPXX Signal Connections

For information about configuring the SCC-LPXX module using NI-DAQmx, refer to the *SCC Quick Start Guide*.

Using the SCC-LPXX when Scaling Voltage Measurements

If you configured the SCC-LPXX using Measurement & Automation Explorer (MAX) and you are using NI-DAQ, the voltage reading you get from the E Series DAQ device accounts for the voltage scaling effect of the SCC-LPXX. Otherwise, you must scale the readings as follows:

1. Read the SCC-LPXX channel on the E Series DAQ device $V_{ESERIES}$ (CHX).
2. Calculate the SCC-LPXX voltage using this formula:

$$V_{LP} = 2V_{ESERIES}$$

where

V_{LP} is the SCC-LPXX input voltage.

$V_{ESERIES}$ is the E Series DAQ device input voltage.

Specifications

These ratings are typical at 25 °C unless otherwise stated.

Amplifier Characteristics

Number of input channels.....	2 DIFF
Input signal range	±10 V
Output signal range.....	±5 V
Gain	0.5
Input impedance	10 GΩ in parallel with 10 pF (powered on) 10 kΩ (powered off or overloaded)
Gain error.....	Adjustable to 0% of reading
Offset-voltage error	350 μV typ (referred to input, RTI) ¹ 1.5 mV max ²

¹ This specification is calculated relative to the input range of the module.

² Applicable at 25 °C.

Input bias current ± 2 nA typ
 ± 5 nA max¹

Nonlinearity 0.004% of full scale

Filter Characteristics

Filter type Fourth-order Butterworth
lowpass

Rolloff rate 80 dB/decade

-3 dB cutoff frequency (fc)

 SCC-LP01 25 Hz

 SCC-LP02 50 Hz

 SCC-LP03 150 Hz

 SCC-LP04 1 kHz

Passband ripple

Input Signal	Typical	Maximum
DC to 1/3 fc	± 0.04 dB	0 ± 0.1 dB
DC to 1/2 fc	± 0.06 dB	0 ± 0.2 dB
DC to 2/3 fc	-0.2 ± 0.25 dB	-0.2 ± 0.4 dB
DC to fc	-3 ± 0.3 dB	-3 ± 0.5 dB

System Noise

Total harmonic distortion (THD) at fc ... < -90 dB

Wide-band noise
(DC to 1 MHz, RTI) $100 \mu\text{V}_{\text{rms}}$

Narrow-band noise
(DC to 33 kHz, RTI) $6 \mu\text{V}_{\text{rms}}$

¹ Applicable at 25 °C.

Stability

Gain temperature coefficient	10 ppm/°C typ 20 ppm/°C max
Offset-voltage temperature coefficient	3.4 μ V/°C typ (RTI) 27 μ V/°C max

Power Requirement

Analog power	
SCC-LP01, SCC-LP02	135 mW max
+15 V	4.5 mA max
-15 V	4.5 mA max
SCC-LP03, SCC-LP04	475 mW max
+15 V	15.8 mA max
-15 V	15.8 mA max
Digital power	0.0 mW max

Physical

Dimensions	8.89 cm \times 2.92 cm \times 1.85 cm (3.50 in. \times 1.15 in. \times 0.73 in.)
Mass	37 g (1.3 oz)
I/O connectors	One 20-pin right-angle male connector, one 4-pin screw terminal
Field-wiring diameter	28 to 16 AWG

Maximum Working Voltage

Maximum working voltage refers to the signal voltage plus the common-mode voltage.

Channel-to-earth (inputs)..... \pm 15 V, Installation Category I

Channel-to-channel (inputs) \pm 15 V, Installation Category I

Environmental

Operating temperature0 to 50 °C

Storage temperature.....-20 to 70 °C

Humidity 10 to 90% RH, noncondensing
Maximum altitude 2,000 m
Pollution Degree (indoor use only) 2

Safety

The SCC-LPXX meets the requirements of the following standards for safety and electrical equipment for measurement, control, and laboratory use:

- IEC 61010-1, EN 61010-1
- UL 3111-1, UL 61010B-1
- CAN/CSA C22.2 No. 1010.1



Note For UL and other safety certifications, refer to the product label, or visit ni.com/hardref.nsf, search by model number or product line, and click the appropriate link in the Certification column.

Electromagnetic Compatibility

Emissions EN 55011 Class A at 10 m
FCC Part 15A above 1 GHz
Immunity EN 61326:1997 + A2:2001,
Table 1
CE, C-Tick, and FCC Part 15 (Class A) Compliant



Note For full EMC compliance, operate this device with shielded cabling. In addition, all covers and filler panels must be installed.

CE Compliance

This product meets the essential requirements of applicable European Directives, as amended for CE marking, as follows:

Low-Voltage Directive (safety): 73/23/EEC

Electromagnetic Compatibility
Directive (EMC) 89/336/EEC



Note Refer to the Declaration of Conformity (DoC) for this product for any additional regulatory compliance information. To obtain the DoC for this product, visit ni.com/hardref.nsf, search by model number or product line, and click the appropriate link in the Certification column.

Theory of Operation

SCC-LPXX Performance

The SCC-LPXX uses a Butterworth filter, which is characterized by maximal flatness in the passband with very sharp monotonic rolloff. It has a nonlinear phase response, the delay is not constant, and the step response exhibits a moderate amount of overshoot (ringing). These characteristics present no problems in applications where only the amplitude of signal frequency components is of interest.

The Butterworth filter is a good general-purpose filter. Figures 2 through 5 show the typical gain response curve for each SCC-LPXX.

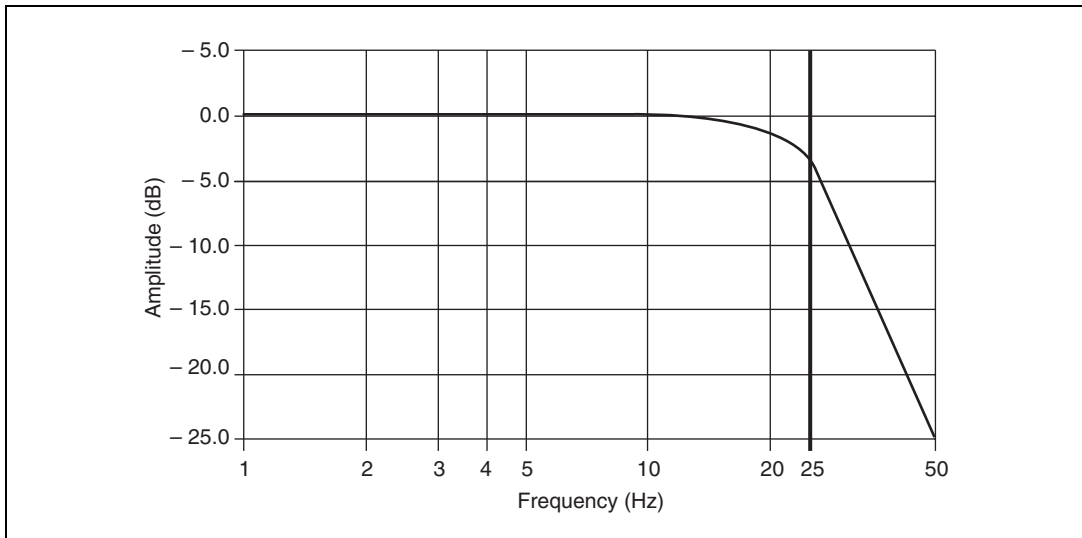

Figure 2. Typical SCC-LP01 Response Curve

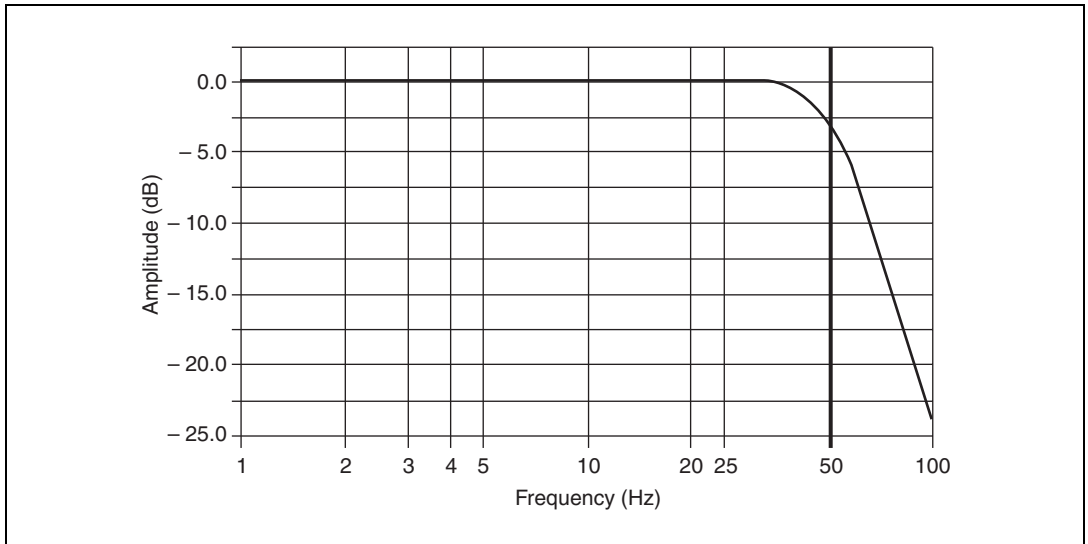

Figure 3. Typical SCC-LP02 Response Curve

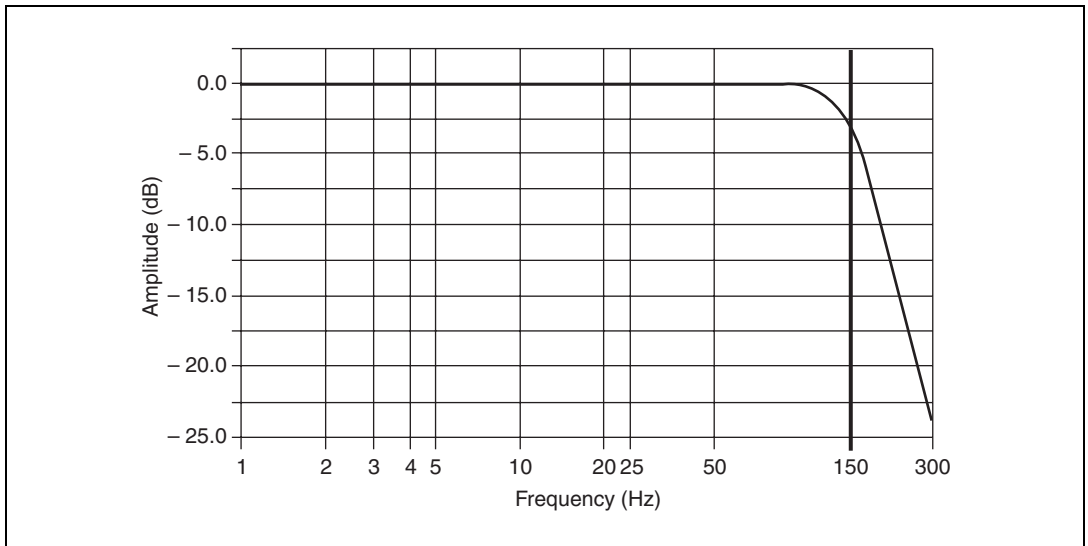

Figure 4. Typical SCC-LP03 Response Curve

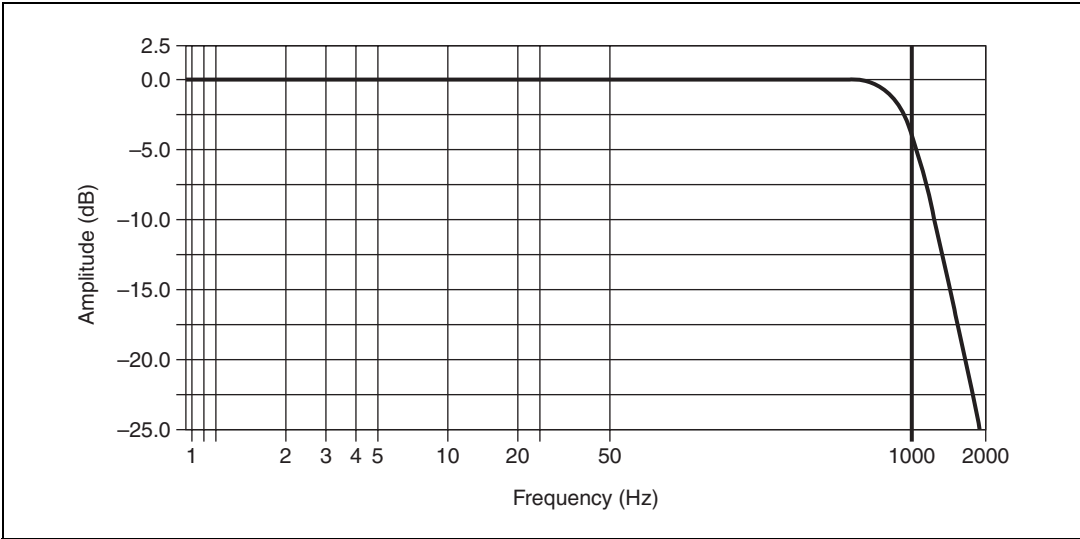

Figure 5. Typical SCC-LP04 Response Curve

Figure 6 shows the theoretical transfer characteristics of the SCC-LPXX.

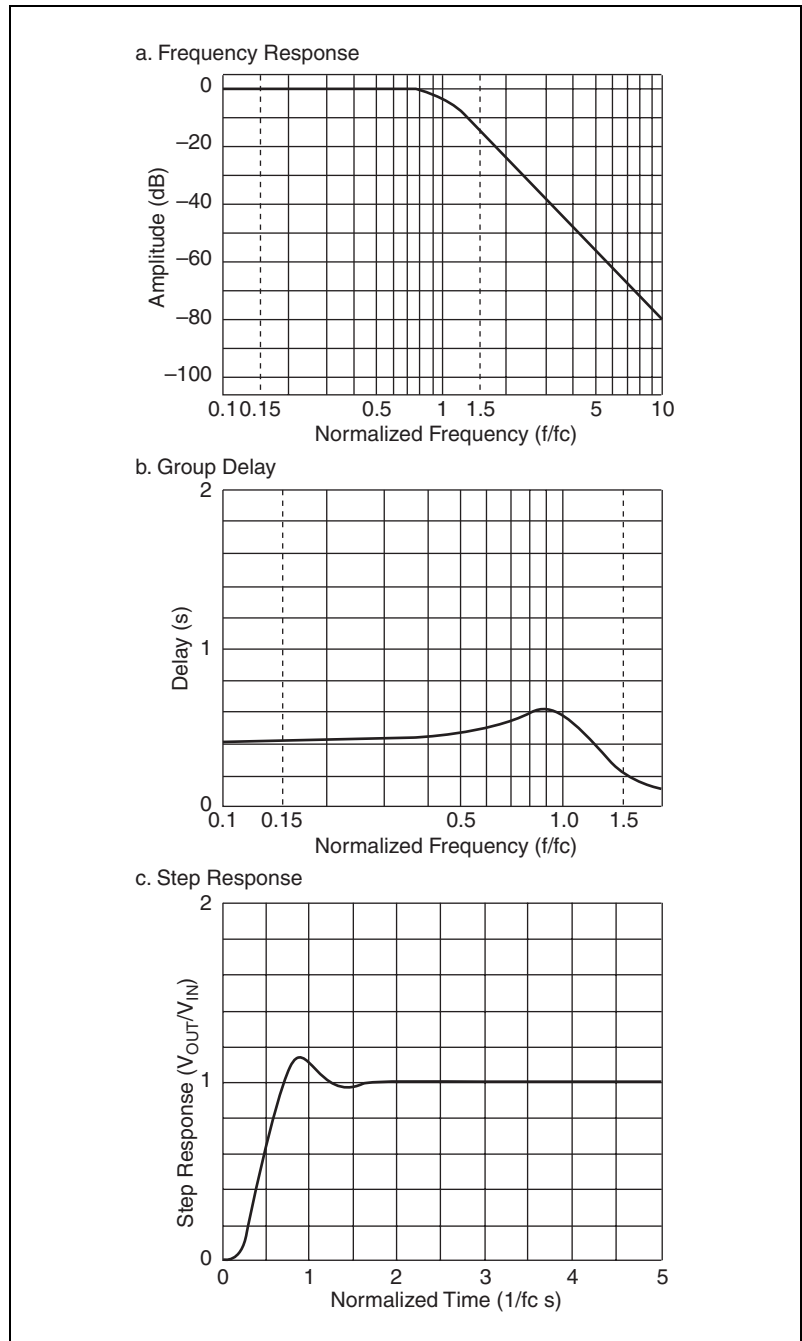

Figure 6. Theoretical Transfer Characteristics

The horizontal axes of the first two plots are normalized to the SCC-LPXX cutoff frequency. When the input frequency (f) equals the cutoff frequency (f_c), the normalized frequency has a value of 1.

The vertical axis of the third plot is normalized to the magnitude of the step input voltage. When the step-response output voltage equals the magnitude of the step-input voltage, the normalized step response is $1 V_{OUT}/V_{IN}$.

Figure 6a shows that the SCC-LPXX provides 80 dB attenuation above ten times the cutoff frequency. Figure 6b shows variation in the group delay of the SCC-LPXX. Figure 6c shows the SCC-LPXX response to a step input. As shown, the peak voltage of the output is greater than the magnitude of the step input. If you expect step inputs, choose a gain setting and input range on the E Series DAQ device that allow for the effects of ringing. Otherwise the DAQ device input may be saturated, resulting in invalid data.

Using the SCC-LPXX as an Antialiasing Filter

Aliasing, a phenomenon of voltage-sampling systems, causes a high-frequency signal to take on the identity of a low-frequency signal.

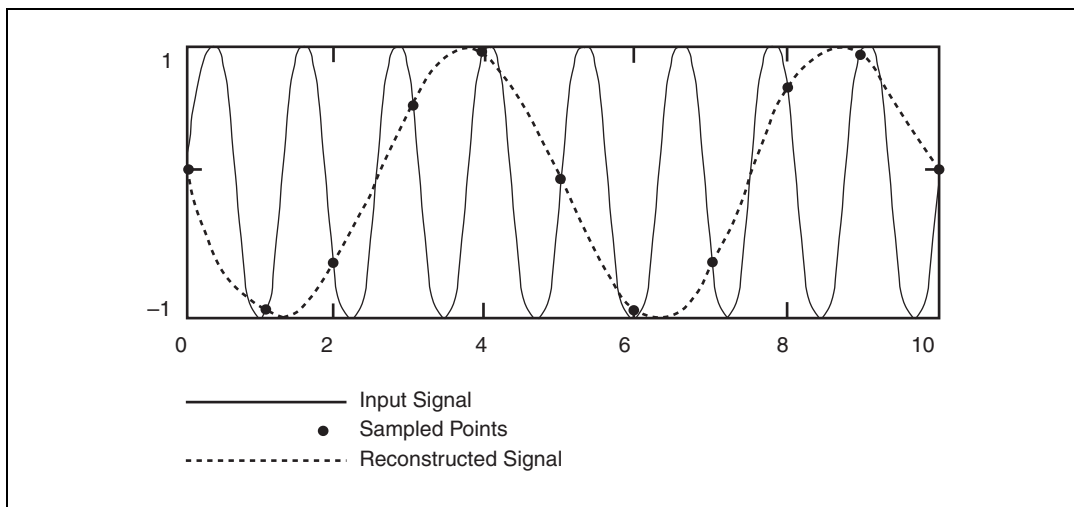

Figure 7. Aliasing of an Input Signal Frequency of 0.8 Times the Sampling Rate

The solid line depicts a high-frequency signal being sampled at the indicated points. However, when these points are connected to reconstruct the waveform, as shown by the dotted line, the signal appears to have a lower frequency. Any signal with a frequency greater than one half of the sampling rate will be aliased and incorrectly analyzed as having a frequency below one half of the sampling rate. This limiting frequency, one half of the sampling rate, is known as the *Nyquist frequency*.

To prevent aliasing, you must remove all of the signal components with frequencies greater than the Nyquist frequency from an input signal *before* you sample it. When you sample the data and aliasing occurs, it is impossible to accurately reconstruct the original signal.

The SCC-LPXX removes these high-frequency signals before they reach the E Series DAQ device and cause aliasing. Because the SCC-LPXX stopband begins at ten times the cutoff frequency (for an attenuation of 80 dB), the Nyquist frequency should be at least ten times the cutoff frequency. Thus, the rate at which the E Series DAQ device samples a channel should be at least 20 times the filter cutoff frequency.

For example, if you use the SCC-LP01, which has a cutoff frequency of 25 Hz, you can calculate the *minimum* scan rate used by the E Series DAQ device to prevent aliasing— $25 \text{ Hz} \times 20 = 500$ samples per second per channel.

Calibrating Gain Errors

The SCC-LPXX is calibrated at the factory before shipment. If you want to calibrate the SCC-LPXX in your system, you need a voltage source capable of providing a DC voltage up to ± 10 V that is several times more accurate than the SCC itself.

To calibrate the SCC-LPXX, complete the following steps for each channel of the module:

1. Select the desired SCC-LPXX channel (X or $X+8$) on the E Series DAQ device.
2. Set the gain on the E Series DAQ device so that the E Series input range is ± 5 V.
3. Connect the voltage source to the screw terminals of the desired channel on the SCC-LPXX.
4. Input 9 VDC to the SCC-LPXX.
5. Using your software, have the E Series DAQ device read the desired channel on the SCC-LPXX. Record the value.
6. Input 0 VDC to the SCC-LPXX.
7. Have the E Series DAQ device read the channel again and record the new value.
8. Calculate the difference between the two values you recorded (*first reading – second reading*).
9. Adjust the appropriate trimpot (X or $X+8$) on the top of the SCC-LPXX. Repeat steps 4 through 8 until the difference you get in step 8 equals 9 V.

For example, you connect 9 VDC to the input of CH (X) and the E Series DAQ device reads 9.05 V at the SCC output; then you connect 0 VDC to the input of CH (X) and the E Series DAQ device reads -0.01 V at the SCC output. Subtract the second value from the first ($9.05 - (-0.01)$) to get a difference of 9.06 V. Because the difference is not equal to 9 V, you adjust the trimpot until the difference in outputs equals 9 V.



Note In this example there may be an offset voltage such that the final voltages are 9.01 V and 0.01 V for a difference of 9 V. The SCC-LPXX trimpot adjusted in step 9 adjusts only for gain errors and does not compensate for this offset voltage.

SCC-LPXX Module Pin Assignments

Figure 8 shows the I/O connector pins on the bottom of the module.

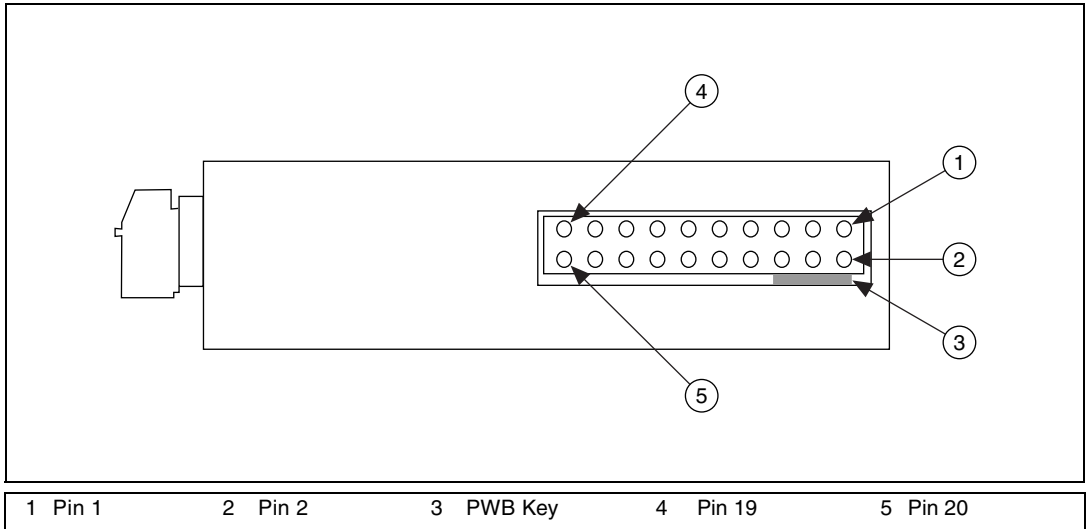

Figure 8. SCC Module Bottom View

Table 1 lists the signal connection corresponding to each pin. AI (X) and AI (X+8) are the analog input signal channels of the E Series DAQ device. AI GND is the analog input ground signal and is the reference for AI (X) and AI (X+8). A GND is the reference for the ± 15 V supplies. AI GND and A GND connect to the SC-2345 at the SCC-PWR connector. You can use pins 17 to 20 for cascading channels. Refer to the *Device Specific Information* section for more information on cascading configurations.

Table 1. SCC-LPXX Pin Signal Connections

Pin Number	Signal
1	E Series AI (X)
2	E Series AI GND
3	—
4	E Series AI (X+8)
5	—
6	E Series AI GND
7	—
8	E Series AI GND
9	—
10	—
11	A GND
12	—
13	+15 V
14	-15 V
15	—
16	—
17	AI (X)- (from first stage)
18	AI (X+8)+ (from first stage)
19	AI (X)+ (from first stage)
20	AI (X+8)- (from first stage)

