

COMPREHENSIVE SERVICES

We offer competitive repair and calibration services, as well as easily accessible documentation and free downloadable resources.

SELL YOUR SURPLUS

We buy new, used, decommissioned, and surplus parts from every NI series. We work out the best solution to suit your individual needs.

 Sell For Cash  Get Credit  Receive a Trade-In Deal

OBSOLETE NI HARDWARE IN STOCK & READY TO SHIP

We stock **New**, **New Surplus**, **Refurbished**, and **Reconditioned** NI Hardware.



Bridging the gap between the manufacturer and your legacy test system.

 1-800-915-6216

 www.apexwaves.com

 sales@apexwaves.com

All trademarks, brands, and brand names are the property of their respective owners.

Request a Quote

 **CLICK HERE**

SCXI-1102B

CALIBRATION PROCEDURE

SCXI™-1102/B/C

For NI-DAQmx

This document contains information and instructions for calibrating the National Instruments SCXI-1102/B/C signal conditioning module.

Contents

| | |
|---|----|
| Conventions | 2 |
| Software | 2 |
| Documentation | 3 |
| Calibration Interval | 3 |
| Password | 3 |
| Test Equipment | 4 |
| Test Conditions | 4 |
| Calibration Process | 5 |
| Initial Setup | 5 |
| Verification Procedure | 7 |
| Adjustment Procedure | 12 |
| Verifying Adjusted Values | 14 |
| Test Limits | 14 |
| Gain and Offset | 15 |
| SCXI-1102/B/C Front and Rear Panel Diagrams | 15 |
| World Wide Support and Services | 18 |

Conventions

The following conventions are used in this document:

» The » symbol leads you through nested menu items and dialog box options to a final action. The sequence **File»Page Setup»Options** directs you to pull down the **File** menu, select the **Page Setup** item, and select **Options** from the last dialog box.



This icon denotes a note, which alerts you to important information.

bold Bold text denotes items that you must select or click in the software, such as menu items and dialog box options. Bold text also denotes parameter names.

italic Italic text denotes variables, emphasis, a cross-reference, or an introduction to a key concept. Italic text also denotes text that is a placeholder for a word or value that you must supply.

monospace Text in this font denotes text or characters that you should enter from the keyboard, sections of code, programming examples, and syntax examples. This font is also used for the proper names of disk drives, paths, directories, programs, subprograms, subroutines, device names, functions, operations, variables, filenames, and extensions.

monospace italic Italic text in this font denotes text that is a placeholder for a word or value that you must supply.

Software

The SCXI-1102/B/C calibration procedure requires the NI-DAQmx driver. NI recommends using the latest driver that supports both your development environment and the SCXI-1102/B/C. NI-DAQmx includes high-level function calls to simplify the task of writing software to calibrate devices. NI-DAQmx supports many programming languages, including LabVIEW, LabWindows™/CVI™, C/C++, C#, and Visual Basic .NET.

Documentation

The following documents are the primary references for writing your calibration utility:

- The *NI-DAQmx Help* includes information about creating applications that use NI-DAQmx.
- The *NI-DAQmx C Reference Help* includes information about the functions in NI-DAQmx.
- The *DAQ Getting Started* guides include information about installing and configuring NI-DAQmx devices.

You can access these documents by selecting

Start»All Programs»National Instruments»NI-DAQmx after installing NI-DAQmx.

For more information about the SCXI-1102/B/C, refer to the *SCXI-1102/B/C User Manual*. For information about installing and configuring SCXI modules, refer to the *SCXI Quick Start Guide*.

Calibration Interval

Calibrate the SCXI-1102/B/C at a regular interval as defined by the measurement accuracy requirements of your application. NI recommends that you perform a complete calibration at least once every year. You can shorten this interval based on the accuracy requirements of your application.

Password

The default password for password-protected operations is NI.

Test Equipment

NI recommends that you use the equipment in Table 1 to calibrate the SCXI-1102/B/C. If these instruments are not available, use the requirements listed in Table 1 to select a suitable substitute.

Table 1. Test Equipment

| Equipment | Recommended Model | Requirements |
|------------------|--------------------------|---------------------|
| Calibrator | Fluke 5700A | 50 ppm |
| DAQ Device | NI 6281 | 16-bit minimum |
| DMM | NI 4070 | 6 1/2 digit, 15 ppm |
| Terminal Block | SCXI-1300 | — |

Test Conditions

Follow these guidelines to optimize the connections and the environment during calibration:

- Keep connections to the SCXI-1102/B/C as short as possible. Long cables and wires can act as antennas, picking up extra noise and thermal offsets that affect measurements.
- Use shielded copper wire for all cable connections to the SCXI-1102/B/C. Use twisted-pair wire to eliminate noise and thermal offsets.
- Maintain the ambient temperature between 18 °C and 28 °C.
- Keep relative humidity below 80%.
- Allow a warm-up time of at least 15 minutes for the SCXI-1102/B/C and 30 minutes for the DAQ device to ensure that the measurement circuitry is at a stable operating temperature.

Calibration Process

The calibration process has the following steps:

1. *Initial Setup*—Configure the SCXI-1102/B/C for calibration.
2. *Verification Procedure*—Verify the existing operation of the SCXI-1102/B/C. This step determines whether the SCXI-1102/B/C is operating within its test limits.
3. *Adjustment Procedure*—Perform an external calibration that adjusts the SCXI-1102/B/C calibration constants with respect to a known voltage source.
4. *Verifying Adjusted Values*—Perform another verification to ensure that the SCXI-1102/B/C is operating within its test limits after adjustments.

Initial Setup

Complete the following steps to configure the SCXI-1102/B/C for calibration:

1. Make sure that all the appropriate driver and application software is installed.
2. Make sure all components involved in the calibration procedure are powered off.
3. Assemble the SCXI-1102/B/C, SCXI chassis, terminal blocks, and DAQ device as shown in Figure 1. You must cable the SCXI-1102/B/C directly to the DAQ device.

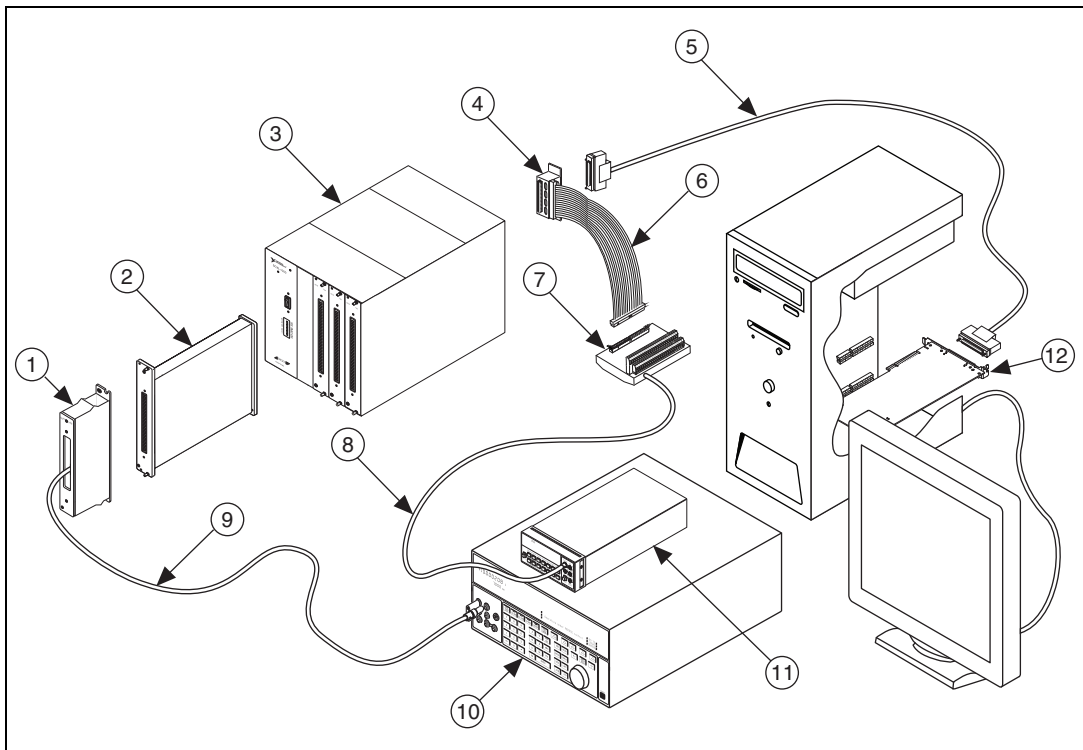

- 1 SCXI-1300 Terminal Block
- 2 SCXI-1102/B/C Module
- 3 SCXI Chassis
- 4 SCXI-1349 Cable Adapter
- 5 Shielded 68-Pin Cable
- 6 NB1 Cable (50-Pin Ribbon Cable)

- 7 TBX 50-Pin Terminal Block
- 8 Cable to DMM
- 9 Cable to Calibrator
- 10 Calibrator
- 11 DMM
- 12 DAQ Device

Figure 1. Calibration Connections

4. Power on the SCXI chassis and the external computer.
5. You must configure the hardware properly with Measurement & Automation Explorer (MAX). Refer to the *SCXI Quick Start Guide* for details about configuring the SCXI chassis.



Note When you configure a device in MAX, the device is assigned a device identifier. In this calibration document, the functions used for demonstrating the calibration process use the device identifiers *Dev1* for the DAQ device and *SCIMod1* for the SCXI-1102/B/C.

Verification Procedure

The verification procedure determines how well the SCXI-1102/B/C is meeting its test limits. You can use this information to select the appropriate calibration interval for your application.

The SCXI-1102/B/C stores gain and offset calibration constants for each gain setting per analog input channel. A complete verification of the inputs involves measuring the accuracy at all possible gain settings on all channels of the SCXI-1102/B/C.

To view the calibration VIs in LabVIEW, select **Measurement I/O»DAQmx - Data Acquisition»DAQmx Advanced»DAQmx Calibration** on the Functions palette. You can also use the **Search** button, shown in Figure 2, to look for a specific VI.

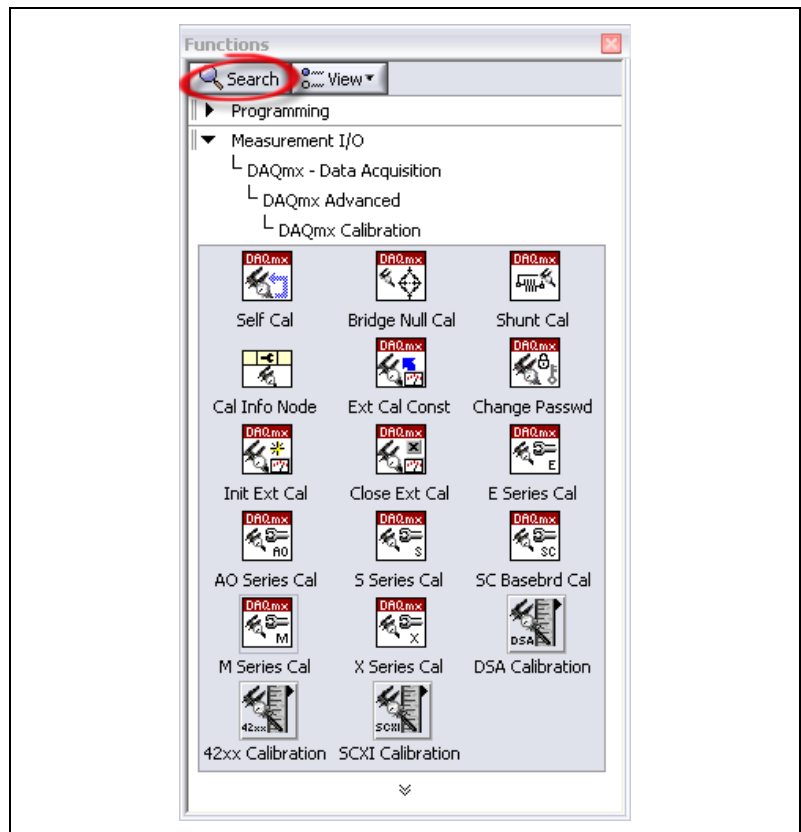



Figure 2. DAQmx Calibration Palette and the Search Button

Complete the following steps to verify the accuracy of each SCXI-1102/B/C analog input channel:

1. Use the DAQmx Self Calibrate VI to verify the DAQ device. This VI measures the onboard reference voltage of the DAQ device and adjusts the self-calibration constants to account for any errors caused by short-term fluctuations in the operating environment.



Note Throughout the verification procedure, refer to the function call parameters for the LabVIEW input values.

| LabVIEW Block Diagram | NI-DAQmx Function Call |
|---|--|
|  | <p>Call <code>DAQmxSelfCal</code> with the following parameter:</p> <p>Device_Name: "Dev1 "</p> |

2. Connect the calibrator output to pins AI- and AI+ for all channels. Refer to the *SCXI-1300/1301 Terminal Block Installation Guide* for connection instructions. If you are not using the recommended SCXI-1300, refer to Table 8 for the front signal pin assignments of the SCXI-1102/B/C. If the calibration signal source is floating, connect AI - to the SCXI chassis ground using the ground lug available on the SCXI terminal block.
3. Set the calibrator voltage to the desired test point indicated in Tables 6 or 7.
4. Create a task using `DAQmxCreateTask`.

| LabVIEW Block Diagram | NI-DAQmx Function Call |
|--|--|
| <p>LabVIEW does not require this step.</p> | <p>Call <code>DAQmxCreateTask</code> with the following parameters:</p> <p>taskName: "AIVerificationTask"</p> <p>taskHandle: &taskHandle</p> |

5. Add a voltage channel using the DAQmx Create Virtual Channel VI.

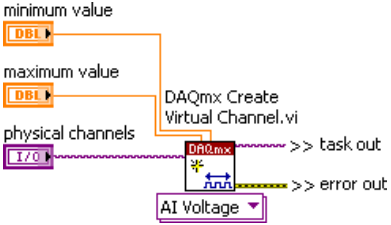
| LabVIEW Block Diagram | NI-DAQmx Function Call |
|---|--|
|  | <p>Call DAQmxCreateAIVoltageChan with the following parameters:</p> <p>taskHandle: taskHandle</p> <p>physicalChannel: "SC1Mod1/aiX"[†]</p> <p>nameToAssignToChannel: "myVoltageChannel"</p> <p>terminalConfig: DAQmx_Val_Cfg_Default</p> <p>minVal: -10 V</p> <p>maxVal: 10 V</p> <p>units: DAQmx_Val_Volts</p> <p>customScaleName: " "</p> <p>[†]Where X refers to the channel you are verifying.</p> |

6. Set the gain value to 1 or 100 using the DAQmx Channel Property Node. You can find the AI.Gain property by selecting **Analog Input»General Properties»Advanced»Gain**. Use the gain setting that corresponds to the current test point.

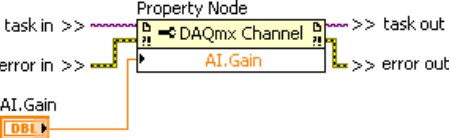
| LabVIEW Block Diagram | NI-DAQmx Function Call |
|--|--|
|  | <p>Call DAQmxSetAIGain with the following parameters:</p> <p>taskHandle: taskHandle</p> <p>Channel: " "</p> <p>Data: (gain value for particular test point) float64</p> |

7. Configure timing for the voltage acquisition using the DAQmx Timing VI.

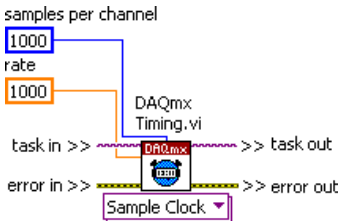
| LabVIEW Block Diagram | NI-DAQmx Function Call |
|---|--|
|  | <p>Call DAQmxCfgSampClkTiming with the following parameters:</p> <p>taskHandle: taskHandle</p> <p>source: " "</p> <p>rate: 1000.0</p> <p>activeEdge: DAQmx_Val_Rising</p> <p>sampleMode: DAQmx_Val_FiniteSamps</p> <p>sampsPerChan: 1000</p> |

8. Commit the verification changes using the DAQmx Control Task VI.

| LabVIEW Block Diagram | NI-DAQmx Function Call |
|---|--|
|  | <p>Call DAQmxTaskControl with the following parameters:</p> <p>taskHandle: taskHandle</p> <p>action: DAQmx_Val_Task_Commit</p> |

9. For each new test point, use the Time Delay Express VI to account for the settling time of the SCXI-1102/B/C. Refer to Table 2 for the settling time of the SCXI-1102/B/C.

Table 2. Settling Time of the SCXI-1102/B/C

| SCXI-1102 | SCXI-1102B, SCXI-1102C |
|----------------------------------|------------------------|
| 3 minutes (first test point) | 5 second |
| 1 minute (all other test points) | |

| LabVIEW Block Diagram | Function Call |
|---|--|
|  | <p>Call a sleep or wait function to suspend execution for the necessary settling time listed in Table 2.</p> |

- Acquire 1000 points of voltage data using the Analog 1D DBL 1Chan NSamp instance of the DAQmx Read VI.

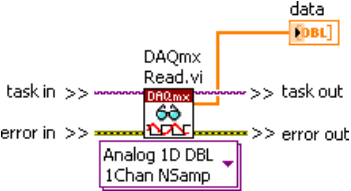
| LabVIEW Block Diagram | NI-DAQmx Function Call |
|---|---|
|  <p>The diagram shows a LabVIEW block diagram for the DAQmx Read VI. It features a 'DAQmx Read.vi' block with a 'DAQmx' icon. The block has two input terminals on the left: 'task in' and 'error in'. It has two output terminals on the right: 'task out' and 'error out'. An orange wire connects the 'task out' terminal to a 'data' terminal, which is connected to a 'DBL' data type icon. Below the 'DAQmx Read.vi' block is a sub-block labeled 'Analog 1D DBL 1Chan NSamp'.</p> | <p>Call DAQmxReadAnalogF64 with the following parameters:</p> <p>taskHandle: taskHandle</p> <p>numSampsPerChan: -1</p> <p>timeout: 10.0</p> <p>fillMode: DAQmx_Val_GroupByChannel</p> <p>readArray: data</p> <p>arraySizeInSamples: 1000</p> <p>sampsPerChanRead: &read</p> <p>reserved: NULL</p> |

- Compute the mean of the 1000 voltage values that you acquired.
- Compare the resulting average to the upper and lower limits listed in Tables 6 or 7. If the result is between the upper and lower limits, the SCXI-1102/B/C passes the test.
- Clear the acquisition using the DAQmx Clear Task VI.

| LabVIEW Block Diagram | NI-DAQmx Function Call |
|---|---|
|  <p>The diagram shows a LabVIEW block diagram for the DAQmx Clear Task VI. It features a 'DAQmx Clear Task.vi' block with a 'DAQmx' icon. The block has two input terminals on the left: 'task in' and 'error in'. It has one output terminal on the right: 'error out'.</p> | <p>Call DAQmxClearTask with the following parameter:</p> <p>taskHandle: taskHandle</p> |

- Repeat steps 4 through 13 for the remaining channels.
- Repeat steps 3 through 14 for all test points in Tables 6 or 7.

You have finished verifying the analog input accuracy of the SCXI-1102/B/C.

Adjustment Procedure

The adjustment procedure adjusts the gain and offset calibration constants on the SCXI-1102/B/C. Complete the [Verification Procedure](#) prior to the adjustment procedure to determine the pre-calibration accuracy and whether adjustments are necessary.

Complete the following steps to adjust the gain and offset of the SCXI-1102/B/C:

1. Connect the calibrator output pins AI- and AI+ for all channels. Refer to the *SCXI-1300/1301 Terminal Block Installation Guide* for connection instructions. If you are not using the recommended SCXI-1300, refer to Table 8 for the front signal pin assignments of the SCXI-1102/B/C. If the calibration signal source is floating, connect AI- to the SCXI chassis ground using the ground lug available on the SCXI terminal block.
2. Connect the DMM to CH 0+ and CH 0- (pin 3 and 4) on the rear connector. Refer to Table 9 for the rear signal pin assignments of the SCXI-1102/B/C.



Note You can access these pins using a 50-pin cable connected to an SCXI-1349.

3. Start an external calibration session using the DAQmx Initialize External Calibration VI.



Note Throughout the adjustment procedure, refer to the function call parameters for the LabVIEW input values.

| LabVIEW Block Diagram | NI-DAQmx Function Call |
|--|---|
| <p>The diagram shows a LabVIEW block diagram for the DAQmx Initialize External Calibration.vi function. The 'device in' input is connected to a dropdown menu showing 'SC1Mod1'. The 'password' input is connected to a text box containing 'NI'. The 'calhandle out' output is connected to a variable reference '&calHandle'. The 'error out' output is connected to an error indicator.</p> | <p>Call DAQmxInitExtCal with the following parameters:</p> <p>deviceName: "SC1Mod1 "</p> <p>password: "NI "</p> <p>calHandle: &calHandle</p> |

- Set the SCXI-1102/B/C to a gain value of 1 or 100 using the DAQmx Setup SCXI Calibration VI.

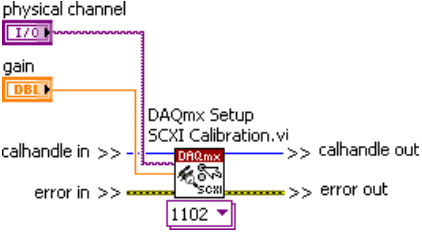
| LabVIEW Block Diagram | NI-DAQmx Function Call |
|---|--|
|  <p>The diagram shows a LabVIEW block diagram for the DAQmx Setup SCXI Calibration VI. It has four input terminals: 'physical channel' (set to 1102), 'gain' (set to DBL), 'calhandle in', and 'error in'. It has two output terminals: 'calhandle out' and 'error out'.</p> | <p>Call DAQmxSetup1102Cal with the following parameters:</p> <p>calHandle: calHandle</p> <p>channelNames: "SC1Mod1/aiX"[†]</p> <p>gain: 1 or 100</p> <p>[†]Where X refers to the channel you are calibrating.</p> |

- Set the calibrator to the desired voltage for the gain value you set in the previous step. Refer to Table 3 or 4 for appropriate voltage set points.

Table 3. SCXI-1102 Voltage Set Points

| Gain | Set Points (V) | | | | | | |
|------|----------------|-------|-------|------|------|------|------|
| 1 | -9 | -6 | -2 | 0 | 2 | 6 | 9 |
| 100 | -0.09 | -0.06 | -0.02 | 0.00 | 0.02 | 0.06 | 0.09 |

Table 4. SCXI-1102 B and SCXI-1102 C Voltage Set Points

| Gain | Set Points (V) | | | | | | |
|------|----------------|-------|-------|------|------|------|------|
| 1 | -9 | -6 | -3 | 0 | 3 | 6 | 9 |
| 100 | -0.09 | -0.06 | -0.03 | 0.00 | 0.03 | 0.06 | 0.09 |

- Wait for the settling time to elapse and then record the measured output from the DMM. Refer to Table 5 for the settling time of the SCXI-1102/B/C.

Table 5. Settling Time of the SCXI-1102/B/C

| SCXI-1102 | SCXI-1102B, SCXI-1102C |
|------------|------------------------|
| 60 seconds | 5 second |

- Adjust the external calibration constants using the DAQmx Adjust SCXI Calibration VI.

| LabVIEW Block Diagram | NI-DAQmx Function Call |
|-----------------------|--|
| | <p>Call DAQmxAdjust1102Cal with the following parameters:</p> <p>calHandle: calHandle</p> <p>refVoltage: (calibrator output voltage) float64</p> <p>measOutput: (voltage measured by DMM) float64</p> |

- Repeat steps 5 through 7 for the seven voltage test points at the current gain value in Table 3 or 4.
- Commit the calibration changes you made in the session using the DAQmx Close External Calibration VI. The data is written to the hardware in this step.

| LabVIEW Block Diagram | NI-DAQmx Function Call |
|-----------------------|--|
| | <p>Call DAQmxCloseExtCal with the following parameters:</p> <p>calHandle: calHandle</p> <p>action: DAQmx_Val_Action_Commit</p> |

- Repeat steps 3 through 9 for both gain values in Table 3.
- Repeat steps 1 through 10 for the remaining channels.

You have finished adjusting the gain and offset of the SCXI-1102/B/C.

Verifying Adjusted Values

After calibrating the SCXI-1102/B/C, NI recommends that you verify the analog input operation by repeating the steps listed in the [Verification Procedure](#) to ensure that the SCXI-1102/B/C is operating within its test limits.

Test Limits

Refer to the *SCXI-1102/B/C User Manual* for the specifications of the SCXI-1102/B/C.

Gain and Offset

Table 6 contains the test limits to use when verifying and adjusting the gain and offset of the SCXI-1102 and SCXI-1102B. Table 7 contains the test limits to use when verifying and adjusting the gain and offset of the SCXI-1102C. If the SCXI-1102/B/C was calibrated within the last year, the test point value should fall between the Lower Limit and Upper Limit values found in Tables 6 or 7.



Note The values in Tables 6 and 7 do not include DAQ device errors.

Table 6. SCXI-1102 and SCXI-1102 B Test Limits

| Gain | Test Point (V) | Upper Limit (V) | Lower Limit (V) |
|------|----------------|-----------------|-----------------|
| 1 | 9.800000 | 9.80345 | 9.79655 |
| | 0.000000 | 0.001002 | -0.001002 |
| | -9.800000 | -9.79655 | -9.80345 |
| 100 | 0.098000 | 0.098060 | 0.097940 |
| | 0.000000 | 0.000030 | -0.000030 |
| | -0.098000 | -0.097940 | -0.098060 |

Table 7. SCXI-1102 C Test Limits

| Gain | Test Point (V) | Upper Limit (V) | Lower Limit (V) |
|------|----------------|-----------------|-----------------|
| 1 | 9.800000 | 9.80345 | 9.79655 |
| | 0.000000 | 0.001002 | -0.001002 |
| | -9.800000 | -9.79655 | -9.80345 |
| 100 | 0.098000 | 0.098060 | 0.097940 |
| | 0.000000 | 0.000030 | -0.000030 |
| | -0.098000 | -0.097940 | -0.098060 |

SCXI-1102/B/C Front and Rear Panel Diagrams

Table 8 shows the pin assignments for the SCXI-1102/B/C front panel connector. Table 9 shows the pin assignments for the SCXI-1102/B/C rear signal connector.

Table 8. Front Signal Pin Assignments

| Front Connector Diagram | | | | Pin Number | Column A | Column B | Column C |
|-------------------------|--|--|--|------------|-----------|----------|----------|
| | | | | 32 | CH GND | AI 0- | AI 0+ |
| | | | | 31 | NC | AI 1- | AI 1+ |
| | | | | 30 | NC | AI 2- | AI 2+ |
| | | | | 29 | NC | AI 3- | AI 3+ |
| | | | | 28 | NC | AI 4- | AI 4+ |
| | | | | 27 | NC | AI 5- | AI 5+ |
| | | | | 26 | NC | AI 6- | AI 6+ |
| | | | | 25 | NC | AI 7- | AI 7+ |
| | | | | 24 | CH GND | AI 8- | AI 8+ |
| | | | | 23 | NC | AI 9- | AI 9+ |
| | | | | 22 | NC | AI 10- | AI 10+ |
| | | | | 21 | NC | AI 11- | AI 11+ |
| | | | | 20 | NC | AI 12- | AI 12+ |
| | | | | 19 | NC | AI 13- | AI 13+ |
| | | | | 18 | NC | AI 14- | AI 14+ |
| | | | | 17 | NC | AI 15- | AI 15+ |
| | | | | 16 | CH GND | AI 16- | AI 16+ |
| | | | | 15 | NC | AI 17- | AI 17+ |
| | | | | 14 | NC | AI 18- | AI 18+ |
| | | | | 13 | NC | AI 19- | AI 19+ |
| | | | | 12 | NC | AI 20- | AI 20+ |
| | | | | 11 | NC | AI 21- | AI 21+ |
| | | | | 10 | NC | AI 22- | AI 22+ |
| | | | | 9 | NC | AI 23- | AI 23+ |
| | | | | 8 | NC | AI 24- | AI 24+ |
| | | | | 7 | NC | AI 25- | AI 25+ |
| | | | | 6 | NC | AI 26- | AI 26+ |
| | | | | 5 | CH GND | AI 27- | AI 27+ |
| | | | | 4 | CJ SENSOR | AI 28- | AI 28+ |
| | | | | 3 | CJ SENSOR | AI 29- | AI 29+ |
| | | | | 2 | CH GND | AI 30- | AI 30+ |
| | | | | 1 | +5 V | AI 31- | AI 31+ |

| | Column | | |
|----|--------|---|---|
| | A | B | C |
| 32 | ○ | ○ | ○ |
| 31 | ○ | ○ | ○ |
| 30 | ○ | ○ | ○ |
| 29 | ○ | ○ | ○ |
| 28 | ○ | ○ | ○ |
| 27 | ○ | ○ | ○ |
| 26 | ○ | ○ | ○ |
| 25 | ○ | ○ | ○ |
| 24 | ○ | ○ | ○ |
| 23 | ○ | ○ | ○ |
| 22 | ○ | ○ | ○ |
| 21 | ○ | ○ | ○ |
| 20 | ○ | ○ | ○ |
| 19 | ○ | ○ | ○ |
| 18 | ○ | ○ | ○ |
| 17 | ○ | ○ | ○ |
| 16 | ○ | ○ | ○ |
| 15 | ○ | ○ | ○ |
| 14 | ○ | ○ | ○ |
| 13 | ○ | ○ | ○ |
| 12 | ○ | ○ | ○ |
| 11 | ○ | ○ | ○ |
| 10 | ○ | ○ | ○ |
| 9 | ○ | ○ | ○ |
| 8 | ○ | ○ | ○ |
| 7 | ○ | ○ | ○ |
| 6 | ○ | ○ | ○ |
| 5 | ○ | ○ | ○ |
| 4 | ○ | ○ | ○ |
| 3 | ○ | ○ | ○ |
| 2 | ○ | ○ | ○ |
| 1 | ○ | ○ | ○ |

NC—No Connection

Table 9. Rear Signal Pin Assignments

| Rear Connector Diagram | Signal Name | Pin Number | Pin Number | Signal Name | | | | | | | | | | | | | | | | | | | | | | | | | | | | | | | | | | | | | | | | | | | | | | | | | | |
|--|-------------|------------|-----------------------|-------------|---|---|---|---|---|----|----|----|----|----|----|----|----|----|----|----|----|----|----|----|----|----|----|----|----|----|----|----|----|----|----|----|----|----|----|----|----|----|----|----|----|----|----|----|----|----|--------|---|---|--------|
| <table border="1"> <tr><td>1</td><td>2</td></tr> <tr><td>3</td><td>4</td></tr> <tr><td>5</td><td>6</td></tr> <tr><td>7</td><td>8</td></tr> <tr><td>9</td><td>10</td></tr> <tr><td>11</td><td>12</td></tr> <tr><td>13</td><td>14</td></tr> <tr><td>15</td><td>16</td></tr> <tr><td>17</td><td>18</td></tr> <tr><td>19</td><td>20</td></tr> <tr><td>21</td><td>22</td></tr> <tr><td>23</td><td>24</td></tr> <tr><td>25</td><td>26</td></tr> <tr><td>27</td><td>28</td></tr> <tr><td>29</td><td>30</td></tr> <tr><td>31</td><td>32</td></tr> <tr><td>33</td><td>34</td></tr> <tr><td>35</td><td>36</td></tr> <tr><td>37</td><td>38</td></tr> <tr><td>39</td><td>40</td></tr> <tr><td>41</td><td>42</td></tr> <tr><td>43</td><td>44</td></tr> <tr><td>45</td><td>46</td></tr> <tr><td>47</td><td>48</td></tr> <tr><td>49</td><td>50</td></tr> </table> | 1 | 2 | 3 | 4 | 5 | 6 | 7 | 8 | 9 | 10 | 11 | 12 | 13 | 14 | 15 | 16 | 17 | 18 | 19 | 20 | 21 | 22 | 23 | 24 | 25 | 26 | 27 | 28 | 29 | 30 | 31 | 32 | 33 | 34 | 35 | 36 | 37 | 38 | 39 | 40 | 41 | 42 | 43 | 44 | 45 | 46 | 47 | 48 | 49 | 50 | AI GND | 1 | 2 | AI GND |
| | 1 | 2 | | | | | | | | | | | | | | | | | | | | | | | | | | | | | | | | | | | | | | | | | | | | | | | | | | | | |
| | 3 | 4 | | | | | | | | | | | | | | | | | | | | | | | | | | | | | | | | | | | | | | | | | | | | | | | | | | | | |
| | 5 | 6 | | | | | | | | | | | | | | | | | | | | | | | | | | | | | | | | | | | | | | | | | | | | | | | | | | | | |
| | 7 | 8 | | | | | | | | | | | | | | | | | | | | | | | | | | | | | | | | | | | | | | | | | | | | | | | | | | | | |
| | 9 | 10 | | | | | | | | | | | | | | | | | | | | | | | | | | | | | | | | | | | | | | | | | | | | | | | | | | | | |
| | 11 | 12 | | | | | | | | | | | | | | | | | | | | | | | | | | | | | | | | | | | | | | | | | | | | | | | | | | | | |
| | 13 | 14 | | | | | | | | | | | | | | | | | | | | | | | | | | | | | | | | | | | | | | | | | | | | | | | | | | | | |
| | 15 | 16 | | | | | | | | | | | | | | | | | | | | | | | | | | | | | | | | | | | | | | | | | | | | | | | | | | | | |
| | 17 | 18 | | | | | | | | | | | | | | | | | | | | | | | | | | | | | | | | | | | | | | | | | | | | | | | | | | | | |
| | 19 | 20 | | | | | | | | | | | | | | | | | | | | | | | | | | | | | | | | | | | | | | | | | | | | | | | | | | | | |
| | 21 | 22 | | | | | | | | | | | | | | | | | | | | | | | | | | | | | | | | | | | | | | | | | | | | | | | | | | | | |
| | 23 | 24 | | | | | | | | | | | | | | | | | | | | | | | | | | | | | | | | | | | | | | | | | | | | | | | | | | | | |
| | 25 | 26 | | | | | | | | | | | | | | | | | | | | | | | | | | | | | | | | | | | | | | | | | | | | | | | | | | | | |
| | 27 | 28 | | | | | | | | | | | | | | | | | | | | | | | | | | | | | | | | | | | | | | | | | | | | | | | | | | | | |
| | 29 | 30 | | | | | | | | | | | | | | | | | | | | | | | | | | | | | | | | | | | | | | | | | | | | | | | | | | | | |
| | 31 | 32 | | | | | | | | | | | | | | | | | | | | | | | | | | | | | | | | | | | | | | | | | | | | | | | | | | | | |
| | 33 | 34 | | | | | | | | | | | | | | | | | | | | | | | | | | | | | | | | | | | | | | | | | | | | | | | | | | | | |
| | 35 | 36 | | | | | | | | | | | | | | | | | | | | | | | | | | | | | | | | | | | | | | | | | | | | | | | | | | | | |
| | 37 | 38 | | | | | | | | | | | | | | | | | | | | | | | | | | | | | | | | | | | | | | | | | | | | | | | | | | | | |
| 39 | 40 | | | | | | | | | | | | | | | | | | | | | | | | | | | | | | | | | | | | | | | | | | | | | | | | | | | | | |
| 41 | 42 | | | | | | | | | | | | | | | | | | | | | | | | | | | | | | | | | | | | | | | | | | | | | | | | | | | | | |
| 43 | 44 | | | | | | | | | | | | | | | | | | | | | | | | | | | | | | | | | | | | | | | | | | | | | | | | | | | | | |
| 45 | 46 | | | | | | | | | | | | | | | | | | | | | | | | | | | | | | | | | | | | | | | | | | | | | | | | | | | | | |
| 47 | 48 | | | | | | | | | | | | | | | | | | | | | | | | | | | | | | | | | | | | | | | | | | | | | | | | | | | | | |
| 49 | 50 | | | | | | | | | | | | | | | | | | | | | | | | | | | | | | | | | | | | | | | | | | | | | | | | | | | | | |
| CH 0+ | 3 | 4 | CH 0- | | | | | | | | | | | | | | | | | | | | | | | | | | | | | | | | | | | | | | | | | | | | | | | | | | | |
| NC | 5 | 6 | NC | | | | | | | | | | | | | | | | | | | | | | | | | | | | | | | | | | | | | | | | | | | | | | | | | | | |
| NC | 7 | 8 | NC | | | | | | | | | | | | | | | | | | | | | | | | | | | | | | | | | | | | | | | | | | | | | | | | | | | |
| NC | 9 | 10 | NC | | | | | | | | | | | | | | | | | | | | | | | | | | | | | | | | | | | | | | | | | | | | | | | | | | | |
| NC | 11 | 12 | NC | | | | | | | | | | | | | | | | | | | | | | | | | | | | | | | | | | | | | | | | | | | | | | | | | | | |
| NC | 13 | 14 | NC | | | | | | | | | | | | | | | | | | | | | | | | | | | | | | | | | | | | | | | | | | | | | | | | | | | |
| NC | 15 | 16 | NC | | | | | | | | | | | | | | | | | | | | | | | | | | | | | | | | | | | | | | | | | | | | | | | | | | | |
| NC | 17 | 18 | NC | | | | | | | | | | | | | | | | | | | | | | | | | | | | | | | | | | | | | | | | | | | | | | | | | | | |
| OUT REF | 19 | 20 | NC | | | | | | | | | | | | | | | | | | | | | | | | | | | | | | | | | | | | | | | | | | | | | | | | | | | |
| NC | 21 | 22 | NC | | | | | | | | | | | | | | | | | | | | | | | | | | | | | | | | | | | | | | | | | | | | | | | | | | | |
| NC | 23 | 24 | D GND | | | | | | | | | | | | | | | | | | | | | | | | | | | | | | | | | | | | | | | | | | | | | | | | | | | |
| SER DAT IN | 25 | 26 | SER DAT OUT | | | | | | | | | | | | | | | | | | | | | | | | | | | | | | | | | | | | | | | | | | | | | | | | | | | |
| DAQ D*/A | 27 | 28 | NC | | | | | | | | | | | | | | | | | | | | | | | | | | | | | | | | | | | | | | | | | | | | | | | | | | | |
| SLOT 0 SEL* | 29 | 30 | NC | | | | | | | | | | | | | | | | | | | | | | | | | | | | | | | | | | | | | | | | | | | | | | | | | | | |
| D GND | 31 | 32 | NC | | | | | | | | | | | | | | | | | | | | | | | | | | | | | | | | | | | | | | | | | | | | | | | | | | | |
| NC | 33 | 34 | NC | | | | | | | | | | | | | | | | | | | | | | | | | | | | | | | | | | | | | | | | | | | | | | | | | | | |
| NC | 35 | 36 | AI HOLD COMP, AI HOLD | | | | | | | | | | | | | | | | | | | | | | | | | | | | | | | | | | | | | | | | | | | | | | | | | | | |
| SER CLK | 37 | 38 | NC | | | | | | | | | | | | | | | | | | | | | | | | | | | | | | | | | | | | | | | | | | | | | | | | | | | |
| NC | 39 | 40 | NC | | | | | | | | | | | | | | | | | | | | | | | | | | | | | | | | | | | | | | | | | | | | | | | | | | | |
| NC | 41 | 42 | NC | | | | | | | | | | | | | | | | | | | | | | | | | | | | | | | | | | | | | | | | | | | | | | | | | | | |
| RSVD | 43 | 44 | NC | | | | | | | | | | | | | | | | | | | | | | | | | | | | | | | | | | | | | | | | | | | | | | | | | | | |
| NC | 45 | 46 | RSVD | | | | | | | | | | | | | | | | | | | | | | | | | | | | | | | | | | | | | | | | | | | | | | | | | | | |
| NC | 47 | 48 | NC | | | | | | | | | | | | | | | | | | | | | | | | | | | | | | | | | | | | | | | | | | | | | | | | | | | |
| NC | 49 | 50 | NC | | | | | | | | | | | | | | | | | | | | | | | | | | | | | | | | | | | | | | | | | | | | | | | | | | | |

NC—No Connection

RSVD—Reserved

World Wide Support and Services

The National Instruments website is your complete resource for technical support. At ni.com/support you have access to everything from troubleshooting and application development self-help resources to email and phone assistance from NI Application Engineers.

Visit ni.com/services for NI Factory Installation Services, repairs, extended warranty, and other services.

Visit ni.com/register to register your National Instruments product. Product registration facilitates technical support and ensures that you receive important information updates from NI.

National Instruments corporate headquarters is located at 11500 North Mopac Expressway, Austin, Texas, 78759-3504. National Instruments also has offices located around the world. For telephone support in the United States, create your service request at ni.com/support or dial 1 866 ASK MYNI (275 6964). For telephone support outside the United States, visit the Worldwide Offices section of ni.com/niglobal to access the branch office websites, which provide up-to-date contact information, support phone numbers, email addresses, and current events.

Refer to the *NI Trademarks and Logo Guidelines* at ni.com/trademarks for more information on National Instruments trademarks. Other product and company names mentioned herein are trademarks or trade names of their respective companies. For patents covering National Instruments products/technology, refer to the appropriate location: **Help»Patents** in your software, the `patents.txt` file on your media, or the *National Instruments Patents Notice* at ni.com/patents. You can find information about end-user license agreements (EULAs) and third-party legal notices in the readme file for your NI product. Refer to the *Export Compliance Information* at ni.com/legal/export-compliance for the National Instruments global trade compliance policy and how to obtain relevant HTS codes, ECCNs, and other import/export data. NI MAKES NO EXPRESS OR IMPLIED WARRANTIES AS TO THE ACCURACY OF THE INFORMATION CONTAINED HEREIN AND SHALL NOT BE LIABLE FOR ANY ERRORS. U.S. Government Customers: The data contained in this manual was developed at private expense and is subject to the applicable limited rights and restricted data rights as set forth in FAR 52.227-14, DFAR 252.227-7014, and DFAR 252.227-7015.