

COMPREHENSIVE SERVICES

We offer competitive repair and calibration services, as well as easily accessible documentation and free downloadable resources.

SELL YOUR SURPLUS

We buy new, used, decommissioned, and surplus parts from every NI series. We work out the best solution to suit your individual needs.

 Sell For Cash  Get Credit  Receive a Trade-In Deal

OBSOLETE NI HARDWARE IN STOCK & READY TO SHIP

We stock **New**, **New Surplus**, **Refurbished**, and **Reconditioned** NI Hardware.



Bridging the gap between the manufacturer and your legacy test system.

 1-800-915-6216

 www.apexwaves.com

 sales@apexwaves.com

All trademarks, brands, and brand names are the property of their respective owners.

Request a Quote

 **CLICK HERE**

FP-1000

The logo consists of a vertical rectangular frame. Inside the frame, the word "FieldPoint" is written vertically in a large, bold, serif font. At the bottom of the frame, there is a stylized graphic of a document or folder with a tab, rendered in shades of gray.

FieldPoint

FieldPoint™ FP-1000/1001 User Manual

August 1998 Edition
Part Number 321631B-01

Internet Support

E-mail: support@natinst.com

FTP Site: <ftp.natinst.com>

Web Address: <http://www.natinst.com>

Bulletin Board Support

BBS United States: 512 794 5422

BBS United Kingdom: 01635 551422

BBS France: 01 48 65 15 59

Fax-on-Demand Support

512 418 1111

Telephone Support (USA)

Tel: 512 795 8248

Fax: 512 794 5678

International Offices

Australia 03 9879 5166, Austria 0662 45 79 90 0, Belgium 02 757 00 20, Brazil 011 288 3336,
Canada (Ontario) 905 785 0085, Canada (Québec) 514 694 8521, Denmark 45 76 26 00,
Finland 09 725 725 11, France 01 48 14 24 24, Germany 089 741 31 30, Hong Kong 2645 3186,
Israel 03 6120092, Italy 02 413091, Japan 03 5472 2970, Korea 02 596 7456, Mexico 5 520 2635,
Netherlands 0348 433466, Norway 32 84 84 00, Singapore 2265886, Spain 91 640 0085, Sweden 08 730 49 70,
Switzerland 056 200 51 51, Taiwan 02 377 1200, United Kingdom 01635 523545

National Instruments Corporate Headquarters

6504 Bridge Point Parkway Austin, Texas 78730-5039 USA Tel: 512 794 0100

Important Information

Warranty

The FieldPoint FP-1000 and FP-1001 network modules are warranted against defects in materials and workmanship for a period of one year from the date of shipment, as evidenced by receipts or other documentation. National Instruments will, at its option, repair or replace equipment that proves to be defective during the warranty period. This warranty includes parts and labor.

The media on which you receive National Instruments software are warranted not to fail to execute programming instructions, due to defects in materials and workmanship, for a period of 90 days from date of shipment, as evidenced by receipts or other documentation. National Instruments will, at its option, repair or replace software media that do not execute programming instructions if National Instruments receives notice of such defects during the warranty period. National Instruments does not warrant that the operation of the software shall be uninterrupted or error free.

A Return Material Authorization (RMA) number must be obtained from the factory and clearly marked on the outside of the package before any equipment will be accepted for warranty work. National Instruments will pay the shipping costs of returning to the owner parts which are covered by warranty.

National Instruments believes that the information in this manual is accurate. The document has been carefully reviewed for technical accuracy. In the event that technical or typographical errors exist, National Instruments reserves the right to make changes to subsequent editions of this document without prior notice to holders of this edition. The reader should consult National Instruments if errors are suspected. In no event shall National Instruments be liable for any damages arising out of or related to this document or the information contained in it.

EXCEPT AS SPECIFIED HEREIN, NATIONAL INSTRUMENTS MAKES NO WARRANTIES, EXPRESS OR IMPLIED, AND SPECIFICALLY DISCLAIMS ANY WARRANTY OF MERCHANTABILITY OR FITNESS FOR A PARTICULAR PURPOSE. CUSTOMER'S RIGHT TO RECOVER DAMAGES CAUSED BY FAULT OR NEGLIGENCE ON THE PART OF NATIONAL INSTRUMENTS SHALL BE LIMITED TO THE AMOUNT THEREFORE PAID BY THE CUSTOMER. NATIONAL INSTRUMENTS WILL NOT BE LIABLE FOR DAMAGES RESULTING FROM LOSS OF DATA, PROFITS, USE OF PRODUCTS, OR INCIDENTAL OR CONSEQUENTIAL DAMAGES, EVEN IF ADVISED OF THE POSSIBILITY THEREOF. This limitation of the liability of National Instruments will apply regardless of the form of action, whether in contract or tort, including negligence. Any action against National Instruments must be brought within one year after the cause of action accrues. National Instruments shall not be liable for any delay in performance due to causes beyond its reasonable control. The warranty provided herein does not cover damages, defects, malfunctions, or service failures caused by owner's failure to follow the National Instruments installation, operation, or maintenance instructions; owner's modification of the product; owner's abuse, misuse, or negligent acts; and power failure or surges, fire, flood, accident, actions of third parties, or other events outside reasonable control.

Copyright

Under the copyright laws, this publication may not be reproduced or transmitted in any form, electronic or mechanical, including photocopying, recording, storing in an information retrieval system, or translating, in whole or in part, without the prior written consent of National Instruments Corporation.

Trademarks

BridgeVIEW™, CVI™, FieldPoint™, LabVIEW™, Lookout™, and natinst.com™ are trademarks of National Instruments Corporation.

Product and company names listed are trademarks or trade names of their respective companies.

WARNING REGARDING MEDICAL AND CLINICAL USE OF NATIONAL INSTRUMENTS PRODUCTS

National Instruments products are not designed with components and testing intended to ensure a level of reliability suitable for use in treatment and diagnosis of humans. Applications of National Instruments products involving medical or clinical treatment can create a potential for accidental injury caused by product failure, or by errors on the part of the user or application designer. Any use or application of National Instruments products for or involving medical or clinical treatment must be performed by properly trained and qualified medical personnel, and all traditional medical safeguards, equipment, and procedures that are appropriate in the particular situation to prevent serious injury or death should always continue to be used when National Instruments products are being used. National Instruments products are NOT intended to be a substitute for any form of established process, procedure, or equipment used to monitor or safeguard human health and safety in medical or clinical treatment.

About This Manual

How to Use This Manual Set.....	ix
Organization of This Manual.....	x
Conventions Used in This Manual.....	x
Related Documentation.....	xi
Customer Communication	xi

Chapter 1

FP-1000/1001 Network Module Overview

Capabilities of the Network Modules	1-1
FP-1000 Connects to RS-232	1-2
FP-1001 Connects to RS-485	1-2

Chapter 2

Hardware Installation and Configuration

Mounting the FP-1000/1001 and Terminal Bases	2-1
Mounting the FP-1000/1001 on a DIN Rail	2-1
Connecting Terminal Bases with DIN Rail Mounting.....	2-3
Removing the FP-1000/1001 from the DIN Rail.....	2-4
Mounting the FP-1000/1001 to a Panel.....	2-4
Connecting Terminal Bases with Panel Mounting	2-5
Removing the FP-1000/1001 and Terminal Bases from the Panel	2-6
Installing I/O Modules onto Terminal Bases	2-6
Connecting the FP-1000 to Your Computer	2-7
RS-232 Interface Specifications	2-8
Connecting the FP-1001 to the Serial Network	2-8
RS-485 Interface Specifications	2-10
RS-485 Network Termination and Biasing	2-10
Configuring the FP-1000/1001	2-12
Setting the Network Address.....	2-13
Setting the Baud Rate	2-15

Connecting Power to the FP-1000/1001.....	2-15
Calculating Power for a FieldPoint Bank	2-16
Completed Hardware Installation	2-17

Chapter 3

Feature Set Description

High-Speed Local Bus.....	3-1
Network Watchdog Timer.....	3-1
SnapShot Feature.....	3-2
Programmable Power-Up State	3-3
HotPnP (Hot Plug and Play).....	3-4
HotPnP During Power-Up	3-5
HotPnP During Operation.....	3-5
Inserting New I/O Modules	3-5
Replacing I/O Modules.....	3-5
Power-On Self Test (POST).....	3-7
LED Indicators	3-7

Chapter 4

Installing and Using the FieldPoint Software

FieldPoint Software Overview	4-1
FieldPoint Explorer Configuration Utility	4-1
BridgeVIEW Server.....	4-2
Lookout Driver Class	4-2
LabVIEW VIs	4-2
LabWindows/CVI Functions	4-2
OPC Server	4-3
Other Options for Communicating with FieldPoint Devices.....	4-3
Data Throughput with the FieldPoint Servers.....	4-4
Installing FieldPoint Software.....	4-4
Using FieldPoint Explorer.....	4-4
Getting Assistance While You Work.....	4-5
Getting Started with FieldPoint Explorer.....	4-7
Using the FieldPoint BridgeVIEW Server	4-12
Using the FieldPoint Lookout Driver Class	4-13
Using the FieldPoint LabVIEW VIs.....	4-16
Using the FieldPoint LabWindows/CVI Functions.....	4-18
Using the FieldPoint OPC Server.....	4-19
Using FieldPoint with an Optomux Server	4-21

Appendix A Specifications

Appendix B Customer Communication

Glossary

Index

Figures

Figure 1-1.	FP-1000 and FP-1001 Network Modules	1-1
Figure 2-1.	DIN Rail Clip in the Unlocked Position	2-1
Figure 2-2.	Installing the FP-1000/1001 Network Module onto a DIN Rail	2-2
Figure 2-3.	Locking the FP-1000/1001 Network Module onto a DIN Rail	2-2
Figure 2-4.	Connecting Terminal Bases	2-3
Figure 2-5.	FieldPoint Network Module	2-4
Figure 2-6.	Installing the Network Panel Mount Accessory	2-5
Figure 2-7.	Module Installation Diagram	2-7
Figure 2-8.	Host Computer Connected to One FP-1000 and Two FP-1001 Network Modules	2-7
Figure 2-9.	RS-232 Connector Pinout for the FP-1000.....	2-8
Figure 2-10.	Host Computer Connected to Three FP-1001 Network Modules.....	2-9
Figure 2-11.	RS-485 Connector Pinout for the FP-1000 and FP-1001	2-10
Figure 2-12.	Terminating RS-485 Using the Combicon Adapter	2-11
Figure 2-13.	Typical Signal Connections for Host Computer Connected to One FP-1000 and Multiple FP-1001 Network Modules.....	2-11
Figure 2-14.	Typical Signal Connections for Host Computer Connected to Multiple FP-1001 Network Modules.....	2-12
Figure 2-15.	Address and Baud Rate Switch.....	2-12
Figure 2-16.	FP-1000/1001 Power Connector Pinout	2-16
Figure 3-1.	LEDs on the FP-1000/1001	3-7
Figure 4-1.	FieldPoint Explorer Window	4-5
Figure 4-2.	ToolTips Showing the Name of an Item.....	4-6
Figure 4-3.	ScreenTips Showing a Description of an Item	4-7
Figure 4-4.	Communication Resource Configuration Window.....	4-8
Figure 4-5.	Channel Configuration Dialog Box	4-10

Figure 4-6.	Creating the FieldPoint Object	4-14
Figure 4-7.	Modifying the FieldPoint Data Members.....	4-15
Figure 4-8.	LabVIEW Diagram for LabVIEW Example Application	4-17
Figure 4-9.	Front Panel for LabVIEW Example Application	4-18

Tables

Table 2-1.	Network Address Switch Settings for the FP-1000/1001	2-14
Table 2-2.	Baud Rate Switch Settings for the FP-1000/1001	2-15
Table 3-1.	Module Configuration Results After HotPnP Replacement.....	3-6
Table 3-2.	STATUS LED Flashes and Corresponding Error Conditions.....	3-8

**About
This
Manual**

This manual describes how to install and use the FieldPoint FP-1000 and FP-1001 network modules.

How to Use This Manual Set

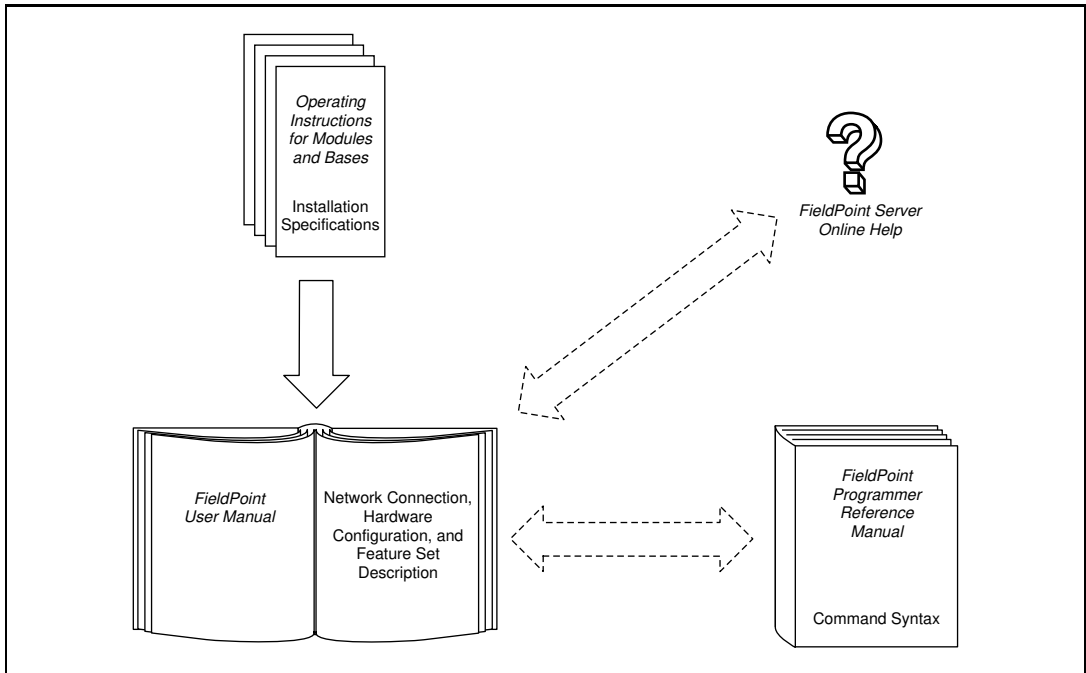

Organization of This Manual

This manual is organized as follows:

- Chapter 1, *FP-1000/1001 Network Module Overview*, provides an overview of the FieldPoint network modules.
- Chapter 2, *Hardware Installation and Configuration*, describes how to install and configure your FieldPoint FP-1000 or FP-1001 network module, connect it to an RS-232 or RS-485 network, and connect power to the network module.
- Chapter 3, *Feature Set Description*, describes the feature set for the FP-1000 and FP-1001 network modules.
- Chapter 4, *Installing and Using the FieldPoint Software*, describes how to use the FieldPoint hardware with various servers and software packages.
- Appendix A, *Specifications*, describes the specifications of the FP-1000 and FP-1001 network modules.
- Appendix B, *Customer Communication*, contains forms you can use to request help from National Instruments or to comment on our products and manuals.
- The *Glossary* contains an alphabetical list and description of terms used in this manual, including abbreviations, acronyms, metric prefixes, mnemonics, and symbols.
- The *Index* contains an alphabetical list of key terms and topics in this manual, including the page number where you can find each one.

Conventions Used in This Manual

The following conventions are used in this manual:



This icon to the left of bold italicized text denotes a note, which alerts you to important information.



This icon to the left of bold italicized text denotes a caution, which advises you of precautions to take to avoid injury, data loss, or a system crash.

bold

Bold text denotes the names of menus, menu items, parameters, dialog box, dialog box buttons or options, icons, windows, Windows 95 tabs, or LEDs.

bold italic

Bold italic text denotes a note or caution.

<i>italic</i>	Italic text denotes emphasis, a cross reference, or an introduction to a key concept. This font also denotes text from which you supply the appropriate word or value, as in Windows 3.x.
<i>italic monospace</i>	Italic text in this font denotes that you must supply the appropriate words or values in the place of these items.
FP-1000/1001	Refers to the FP-1000 network module and/or the FP-1001 network module, in cases where the text applies to both modules. Any specific differences are noted.
monospace	Text in this font denotes text or characters that you should literally enter from the keyboard, sections of code, programming examples, and syntax examples. This font is also used for the proper names of disk drives, paths, directories, programs, subprograms, subroutines, device names, functions, operations, variables, filenames and extensions, and for statements and comments taken from programs.

Related Documentation

The following documents contain information that you may find helpful as you read this manual:

- Operating Instructions (for network module, terminal bases, and I/O modules)
- FieldPoint Server online help

Customer Communication

National Instruments wants to receive your comments on our products and manuals. We are interested in the applications you develop with our products, and we want to help if you have problems with them. To make it easy for you to contact us, this manual contains comment and configuration forms for you to complete. These forms are in Appendix B, *Customer Communication*, at the end of this manual.

FP-1000/1001 Network Module Overview

Chapter

1

This chapter provides an overview of the FieldPoint network modules.

Capabilities of the Network Modules

A FieldPoint system consists of at least one network module, at least one terminal base, and one or more I/O modules.

The FP-1000 FieldPoint network module connects an industrial RS-232 network to FieldPoint I/O modules. The FP-1001 FieldPoint network module connects an industrial RS-485 network to FieldPoint I/O modules.

Figure 1-1 shows the FP-1000 and FP-1001 network modules.

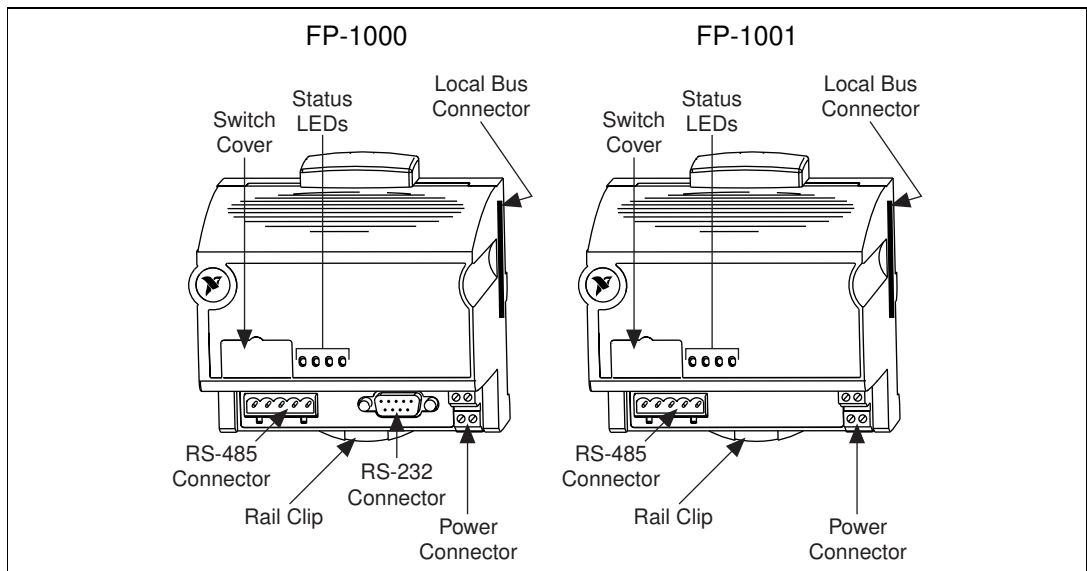

Figure 1-1. FP-1000 and FP-1001 Network Modules

The FP-1000/1001 supports standard commands (subset of Optomux command set) and a set of extended commands to completely support the FieldPoint I/O modules. Both network modules can co-exist with other Optomux devices on the same network.

The FP-1000/1001 uses the Optomux protocol. Therefore, after you have configured the FieldPoint bank (network module and I/O modules), you can use any application software that supports Optomux to communicate with FieldPoint modules in the bank.

In a distributed application, many FieldPoint banks are networked together. You can network up to 25 FieldPoint banks to each RS-232/RS-485 port of your host computer. Each bank can contain up to nine I/O modules, thus connecting up to 225 I/O modules per RS-232 (or RS-485) port in your host computer. You can further increase your field I/O count by using more RS-232/RS-485 ports in your host computer.

FP-1000 Connects to RS-232

The FP-1000 connects directly to the RS-232 port that is available on most host computers. Because RS-232 is a point-to-point network that allows connection to only one device, the FP-1000 provides an RS-485 repeater so that you can build a network with multiple FieldPoint banks by connecting one or more FP-1001s to a single FP-1000.

FP-1001 Connects to RS-485

The FP-1001 FieldPoint network module connects directly to any RS-485 adapter card installed in your host computer, or to the RS-485 repeater port of an FP-1000. Because RS-485 is inherently a multidrop network, the FP-1001 does not provide a separate RS-485 repeater. You can network multiple FP-1001 modules in multidrop fashion.

The FP-1001 communicates over RS-485, utilizing full-duplex mode. It is optically isolated, which prevents fault coupling between the RS-485 network and the FP-1001.

Hardware Installation and Configuration

Chapter

2

This chapter describes how to install and configure your FieldPoint FP-1000 or FP-1001 network module, connect it to an RS-232 or RS-485 network, and connect power to the network module.

Mounting the FP-1000/1001 and Terminal Bases

You can choose either of two methods of securely mounting a FieldPoint system: DIN rail mounting or direct panel mounting. Mounting directly to a panel is generally the more secure of the two options, but DIN rail mounting may be more convenient in your application. The following sections give instructions for both mounting methods.

Mounting the FP-1000/1001 on a DIN Rail

The FieldPoint network modules have rugged, simple clips for reliable mounting onto a standard 35 mm DIN rail. Follow these steps to mount the FP-1000/1001 network module onto a DIN rail.

1. Use a flat-bladed screwdriver to open the DIN rail clip to the unlocked position, as shown in Figure 2-1.

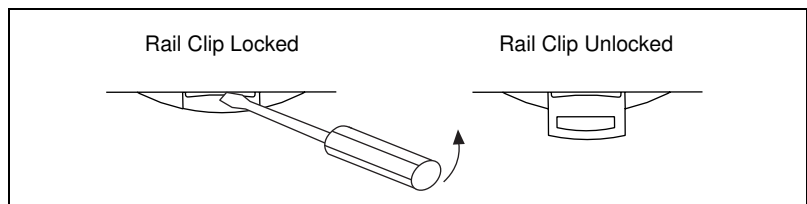

Figure 2-1. DIN Rail Clip in the Unlocked Position

2. Hook the lip on the rear of the network module onto the top of a 35 mm DIN rail and press the network module down onto the DIN rail as shown in Figure 2-2.

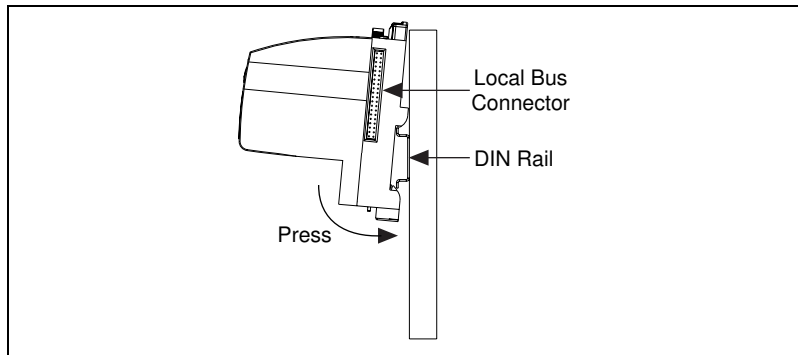

Figure 2-2. Installing the FP-1000/1001 Network Module onto a DIN Rail

3. Slide the network module to the desired position on the DIN rail. After the module is in position, push the rail clip into the locked position to lock the module in place on the DIN rail, as shown in Figure 2-3.

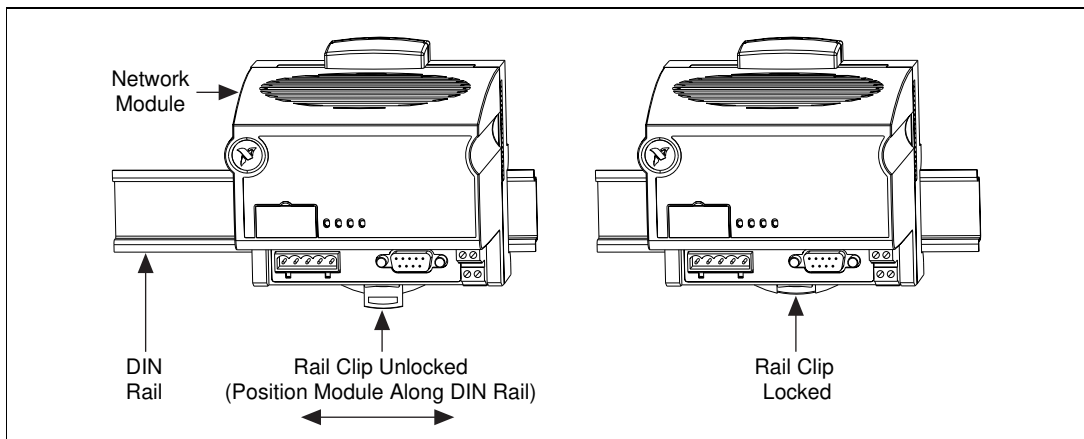

Figure 2-3. Locking the FP-1000/1001 Network Module onto a DIN Rail

After the network module is installed, connect the terminal base to the network module as explained in the next section, [Connecting Terminal Bases with DIN Rail Mounting](#).

Connecting Terminal Bases with DIN Rail Mounting

Follow these steps to connect a terminal base to an FP-1000/1001 network module when you are using DIN rail mounting.



Note: *Ensure that power is not applied to the network module before you install or remove terminal bases.*

1. Remove the protective cover from the network module's local bus connector (see Figure 2-2) or from the bag of accessories that came with your network module.
2. Install the terminal base onto the DIN rail in the same way you installed the network module.
3. Attach the terminal base to the network module by firmly mating the local bus connectors.
4. To add more terminal bases, install them on the rail and connect their local bus connectors together.
5. Place the protective cover onto the last terminal base on the bank, as shown in Figure 2-4.

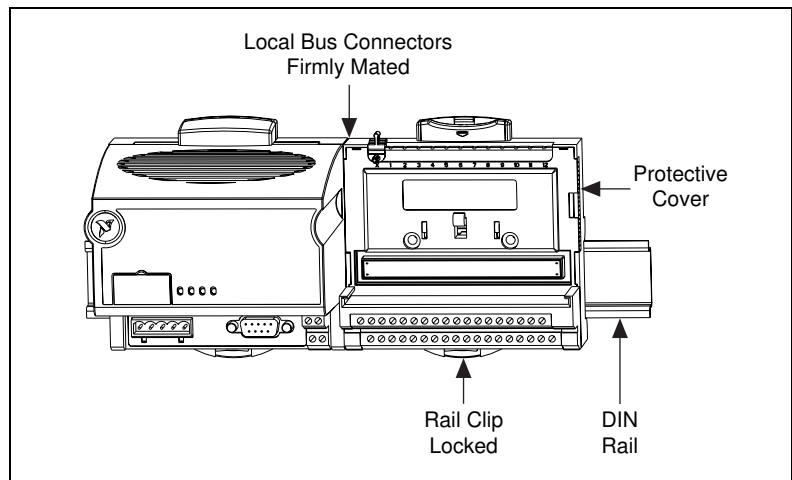

Figure 2-4. Connecting Terminal Bases

Removing the FP-1000/1001 from the DIN Rail

To remove an FP-1000/1001 network module, unlock it from the DIN rail by placing a screwdriver in the slot on the rail clip and opening it to the unlocked position as shown in Figure 2-1.

Then, disconnect the module from the local bus connector of the terminal base, and lift the module off of the rail.

Mounting the FP-1000/1001 to a Panel

Perform the following steps to install the optional FieldPoint network panel mount accessory and mount the FP-1000/1001 network module. You can order the panel mount accessory, part number 777609-01, from National Instruments.

1. Make sure that the rail clip on the network module is unlocked. Figure 2-5 shows a FieldPoint network module and the locked and unlocked positions of the rail clip.

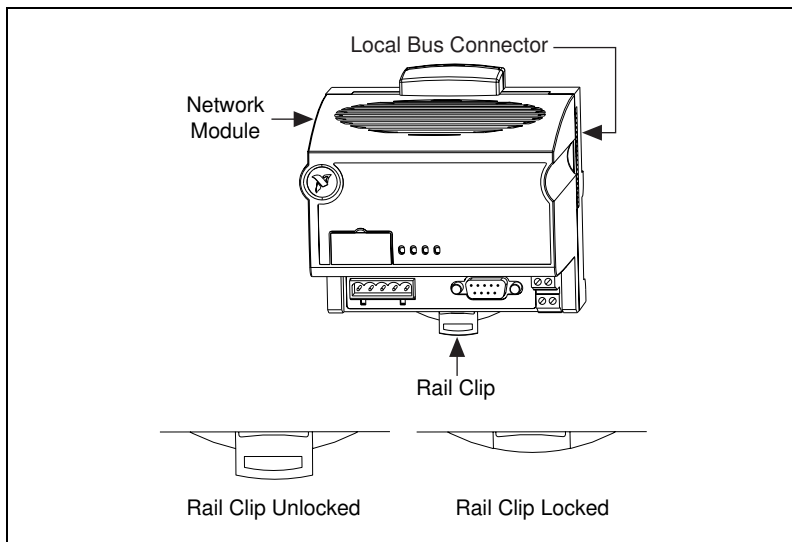

Figure 2-5. FieldPoint Network Module

2. Snap the panel mount accessory onto the module as shown in Figure 2-6.

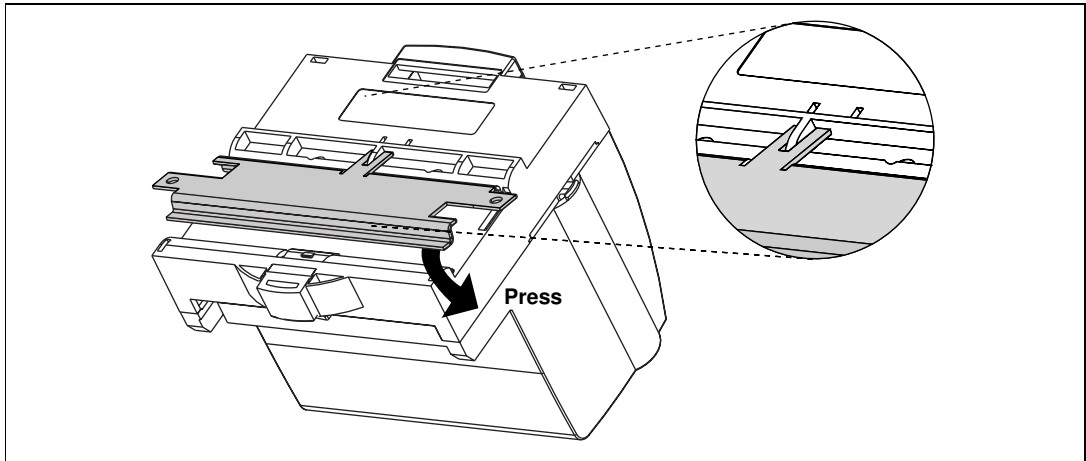

Figure 2-6. Installing the Network Panel Mount Accessory

3. Press on the rail clip to lock it. The locked position is shown in Figure 2-5.
4. Mount the network module with the panel mount accessory. The installation guide that came with the panel mount accessory includes a guide you can use to drill pilot holes for mounting the module.

Connecting Terminal Bases with Panel Mounting

The terminal bases can be directly installed without using the panel mount accessory that is needed for mounting the FP-1000/1001 network module. Follow these steps to connect terminal bases to a network module when you are using panel mounting.



Note: *Ensure that power is not applied to the network module before you install or remove terminal bases.*

1. Remove the protective cover from the network module's local bus connector (see Figure 2-5).
2. Drill pilot holes in the panel to mount the terminal bases. A drilling guide is provided with the network module panel mount accessory.
3. Attach the terminal base to the network module by firmly mating the local bus connectors.

4. Bolt, screw, or otherwise fasten the terminal base to the panel. Ensure that the local bus connectors remain firmly mated after the terminal base is mounted.
5. To add more terminal bases, repeat Steps 2 through 4, mating the local bus connectors of each new terminal base to the connector of the last installed base. If all the pilot holes were correctly drilled, the local bus connectors should all remain firmly mated after all the bases are mounted to the panel.
6. Place the protective cover that you removed from the network module in Step 1 onto the local bus connector of the last terminal base on the bank.

Removing the FP-1000/1001 and Terminal Bases from the Panel

To remove the FP-1000/1001 network module and terminal bases from the panel, reverse the process described in the previous sections, [Mounting the FP-1000/1001 to a Panel](#) and [Connecting Terminal Bases with Panel Mounting](#). First remove the terminal bases, starting with the last one, then remove the network module.

Installing I/O Modules onto Terminal Bases

To connect an I/O module, install it onto a terminal base. Refer to Figure 2-7 and follow these steps:

1. Position the first module with its alignment slots aligned with the guide rails on the terminal base.
2. Press firmly to seat the module on the terminal base. The terminal base latch locks the I/O module into place when the module is firmly seated.
3. To connect additional I/O modules, repeat the procedure to install them onto additional terminal bases.

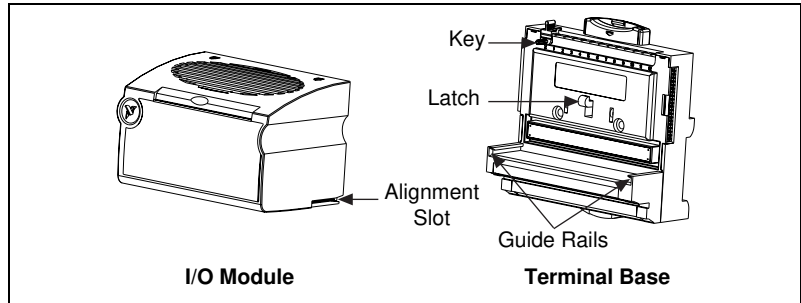

Figure 2-7. Module Installation Diagram

Connecting the FP-1000 to Your Computer

This section describes the network configurations possible with the FP-1000 network module.

Connect the RS-232 port of the FP-1000 to your host computer's RS-232 port. Use a 9-pin DSUB male-to-female straight-through cable. Do not use a null modem cable (usually female-to-female).

You can connect only one FP-1000 for each RS-232 port in your host computer. You can add more FieldPoint banks without using more RS-232 ports of your host computer, by connecting one or more (up to 24) FP-1001 network modules to the RS-485 repeater port of the FP-1000. This network configuration is shown in Figure 2-8.

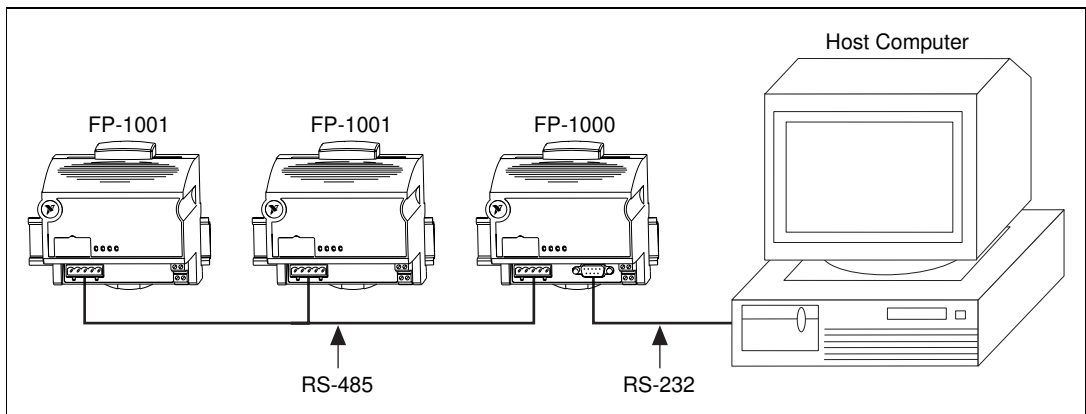

Figure 2-8. Host Computer Connected to One FP-1000 and Two FP-1001 Network Modules

The RS-485 repeater port on the FP-1000 must always be wired in 4-wire, full-duplex mode.

RS-232 Interface Specifications

RS-232 specifies a maximum cabling distance of 50 ft., but improvements in line drivers and cabling technology often allow you to design your network beyond the recommendations of the specification.

The RS-232 connector is 9-pin female DSUB connector whose pinout is shown in Figure 2-9.

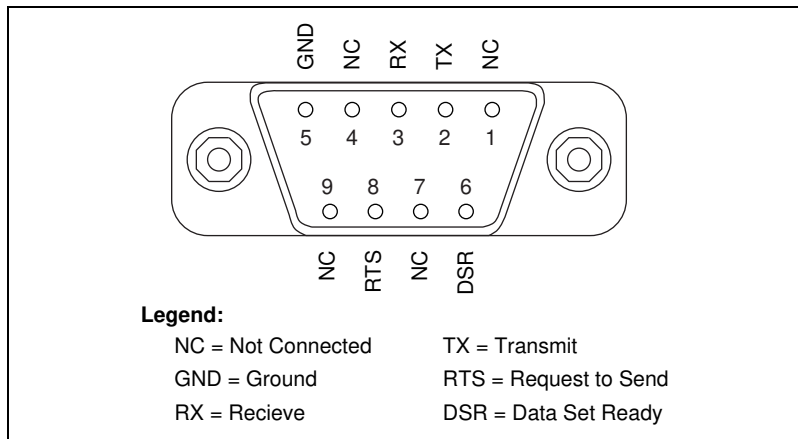

Figure 2-9. RS-232 Connector Pinout for the FP-1000

The FP-1000 does not use RS-232 hardware handshaking, but it still asserts the RTS and DSR signals for host computers or software that may require these signals. A host computer that does not use these signals does not need to connect to them.

Connecting the FP-1001 to the Serial Network

This section describes the network configurations possible with the FP-1001 FieldPoint network module.

One option for connecting the FP-1001 is to connect it to the RS-485 repeater port of an FP-1000 as shown in Figure 2-8. The RS-485 port on the FP-1001 must be wired in 4-wire, full duplex mode when connected to the RS-485 repeater port.

An alternative method is to connect the FP-1001 directly to your host computer, if your host computer provides an RS-485 interface. Contact National Instruments for information about available RS-485 hardware. You can connect up to 25 FP-1001 network modules to each RS-485 port on the host computer. This network configuration method is shown in Figure 2-10.

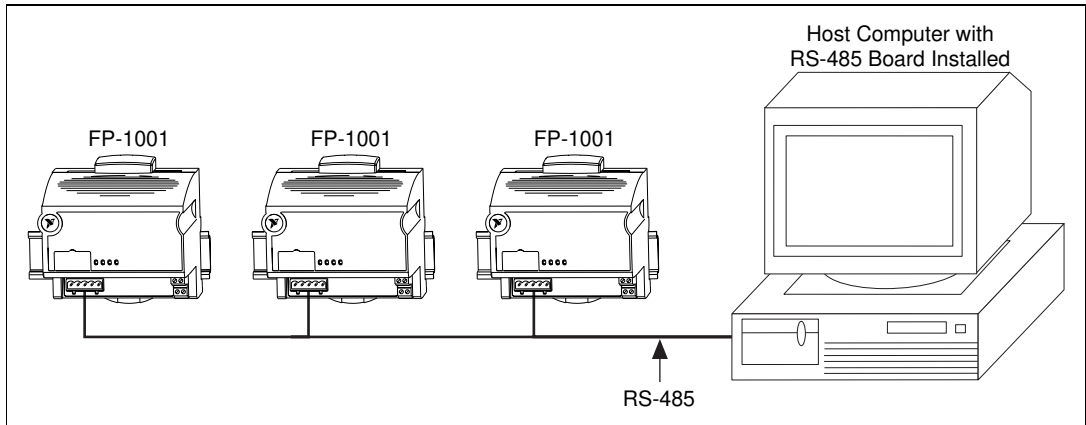

Figure 2-10. Host Computer Connected to Three FP-1001 Network Modules

When the FP-1001 is cabled directly to an RS-485 port on a host computer, as shown in Figure 2-10, you can wire it in either 4-wire full duplex mode or 2-wire half duplex mode.

The multidrop topology used by the RS-485 network in these two networking configurations protects against power failures at individual FieldPoint banks. It eliminates the possibility that a power failure at one FP-1001 bank might affect the communication between other banks in your network. Because the FP-1000 provides an RS-485 repeater, a power failure at that bank affects communications.



Caution: *Do not use the isolation barrier of the RS-485 interface as a way to protect human contact from common-mode voltages of more than 250 Vrms. The RS-485 interface on both the FP-1000 and the FP-1001 modules is isolated from the rest of the FieldPoint system, including the power supply, backplane, and the RS-232 interface on the FP-1000. It is isolated with a galvanic and optical isolation barrier, which has been designed and tested to withstand fault voltages of up to 2500 Vrms. However, the safety rating of this barrier is only for working voltages of up to 250 Vrms. Also note that while the RS-232 interface on the FP-1000 is isolated from the RS-485*

interface, it is NOT isolated from the power supply inputs (the V and C terminals).

RS-485 Interface Specifications

RS-485 specifies a maximum cabling distance of 4000 ft., but improvements in line drivers and cabling technology often allow you to design your network beyond the recommendations of the specification. If even longer distances are desirable, you can use RS-485 repeaters.

An RS-485 stub is created when you tap the RS-485 backbone to form a T-junction. RS-485 stubs must be less than 3 in. long. However, you can create longer stubs by using an RS-485 repeater to start the stub, ensuring that the repeater is close to the junction.

The RS-485 connector is a 5-pin Combicon connector whose pinout is shown in Figure 2-11.

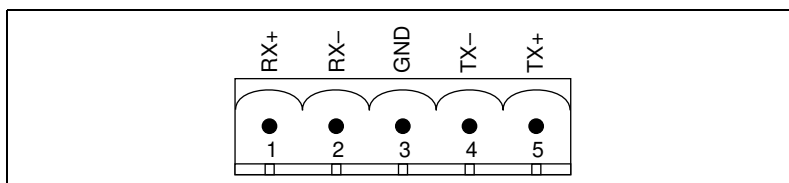

Figure 2-11. RS-485 Connector Pinout for the FP-1000 and FP-1001

RS-485 Network Termination and Biasing

An RS-485 network must be terminated at each end of the network, but not anywhere else. At each end bank, termination resistors should be installed between the RX pair and between the TX pair. These network terminating resistors are nominally 120 Ω and are provided in your kit. To install them, twist the resistor leads with the RS-485 signal wires and then insert them into the RS-485 Combicon adapter as shown in Figure 2-12. The 120 Ω resistor in the figure is a terminating resistor.

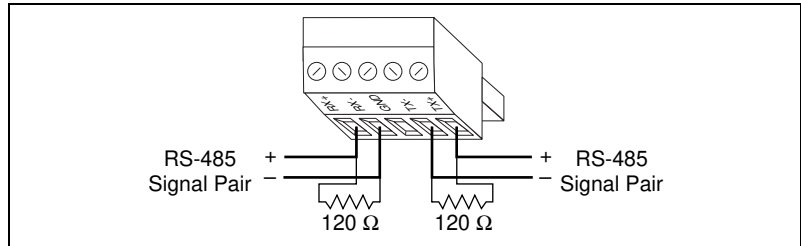

Figure 2-12. Terminating RS-485 Using the Combicon Adapter

An RS-485 network also needs biasing resistors to protect the devices on the network against noise during intervals when no RS-485 drivers are transmitting on the network. The host computer's RS-485 interface normally has provision for such biasing resistors. When you are using FP-1001 network modules directly connected to a host computer's RS-485 interface, you should use the biasing feature of the host computer's RS-485 interface for better reliability and noise immunity. The RS-485 repeater interface on the FP-1000 already has biasing resistors, so you do not need to do anything when connecting one or more FP-1001 modules to the FP-1000.

Figures 2-13 and 2-14 show typical RS-232 and RS-485 signal connections and termination for a FieldPoint network. Figure 2-13 is a more detailed depiction of Figure 2-8, and Figure 2-14 is a more detailed depiction of Figure 2-10.

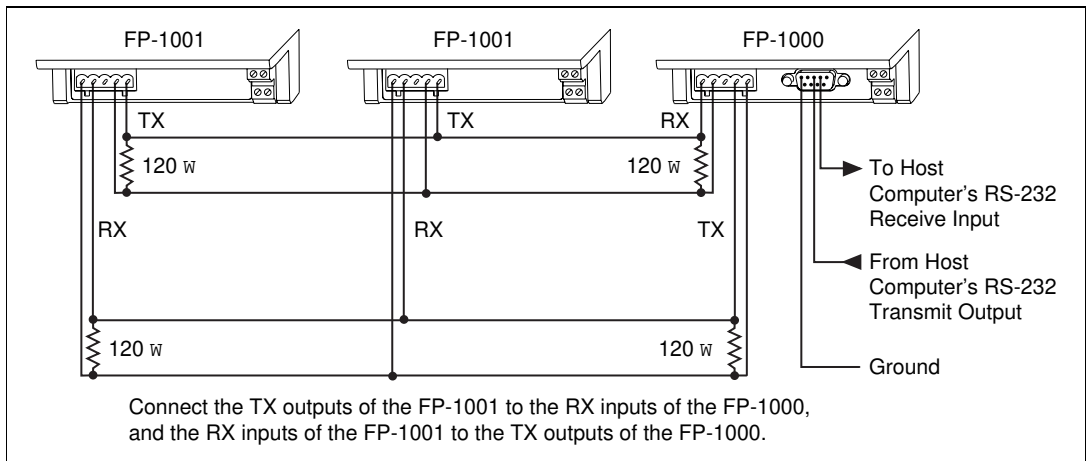

Figure 2-13. Typical Signal Connections for Host Computer Connected to One FP-1000 and Multiple FP-1001 Network Modules

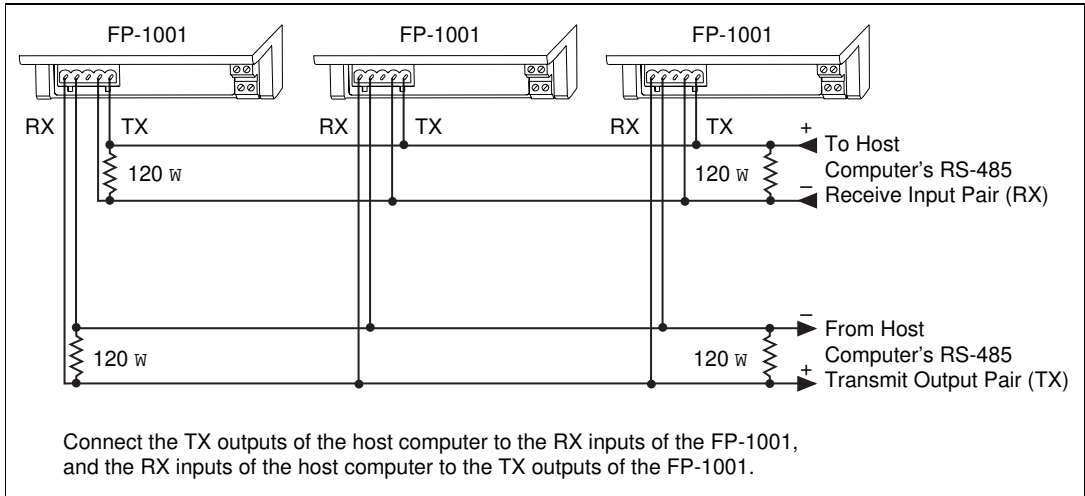

Figure 2-14. Typical Signal Connections for Host Computer Connected to Multiple FP-1001 Network Modules

Configuring the FP-1000/1001

Figure 2-15 shows the 8-position switch on the FP-1000/1001 network module. Switches 1–5 set the network address, and switches 6–8 set the baud rate.

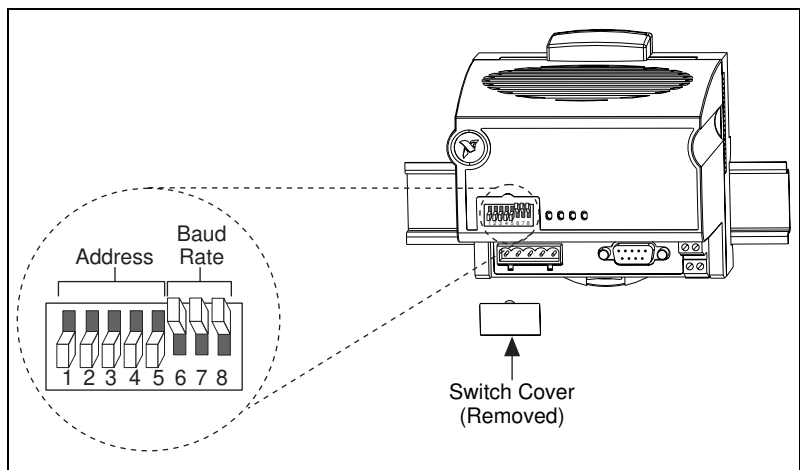

Figure 2-15. Address and Baud Rate Switch

The FP-1000/1001 is preconfigured for network address 0 and a baud rate of 115.2 kbps. If you are connecting only a single network module, you do not need to change the network address from the preconfigured setting of address 0. You should not need to change the baud rate setting unless you are experiencing communication problems.

Follow these steps if you need to change the address and baud rate for your FP-1000/1001 network module.

1. Choose and set a network address. Refer to the following section, *Setting the Network Address*, for more information.
2. Choose and set the baud rate. For more information, refer to the *Setting the Baud Rate* section, later in this chapter.
3. Write your address and baud rate settings in the space provided on the FP-1000/1001 label.
4. Apply (or cycle) power to the bank, to enable the FP-1000/1001 for the new network address and baud rate.
5. Make the same address and baud rate changes in your FieldPoint software. Refer to Step 4 in the *Getting Started with FieldPoint Explorer* section of Chapter 4, *Installing and Using the FieldPoint Software*, for more information.

Setting the Network Address

























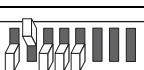

Note: *If you are connecting only a single FP-1000/1001 network module, you do not need to change the network address from the preconfigured setting of address 0. If you are connecting more than one network module to the same host computer port, ensure that each network module has a unique address.*

Switches 1–5 set the network module address. The addresses of the terminal bases in a FieldPoint bank are automatically configured by the network module to be sequentially higher than the network module's address. For example, if the network module is set to address 20, the I/O module in the terminal base adjacent to the network module is at address 21, the next I/O module is at address 22, and so on. A terminal base is assigned an address whether an I/O module is inserted on it or not. The network module's address is determined by the settings of the switches when the modules is powered on. If the switch settings are changed while the module is powered, the module must be powered off then on again before the new settings are applied.

Table 2-1 shows the possible switch positions and the corresponding address of the FieldPoint network module.

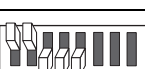
Table 2-1. Network Address Switch Settings for the FP-1000/1001

Switch Positions 1–5	Network Module Address (Decimal)	Switch Positions 1–5	Network Module Address (Decimal)
	0		130
	10		140
	20		150
	30		160
	40		170
	50		180
	60		190
	70		200
	80		210
	90		220
	100		230
	110		240
	120	Other Settings	Not Allowed

Setting the Baud Rate

Switches 6–8 set the network module baud rate. Table 2-2 shows the switch positions and the corresponding network baud rates of the FP-1000/1001 network module. The network module's baud rate is determined by the settings of the switches when the module is powered on. If the switch settings are changed while the module is powered, the module must be powered off then on again before the new settings are applied.









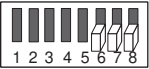

Note:

The preconfigured setting of 115.2 kbps should provide the fastest performance, and you should not need to change this setting unless you are experiencing communication problems. If you are connecting more than one network module to the same host computer port, ensure that every network module's baud rate setting is identical.

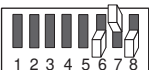
The serial interface on the FP-1000/1001 always uses the following parameters: 1 start bit, 8 data bits, 1 stop bit, and no parity.

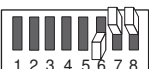
Table 2-2. Baud Rate Switch Settings for the FP-1000/1001

Switch Positions 6–8	Network Module Baud Rate	Switch Positions 6–8	Network Module Baud Rate
	300		19200
	1200		38400
	2400		57600
	9600		115200

Connecting Power to the FP-1000/1001

An 11–30 VDC power supply is required by each FieldPoint network module. The network module filters and regulates this supplied power and provides power for all the I/O modules in the bank. Therefore you need not provide power separately to each FieldPoint I/O module in the bank.

The power connector is a 4-pin screw terminal connector whose pinout is shown in Figure 2-16.

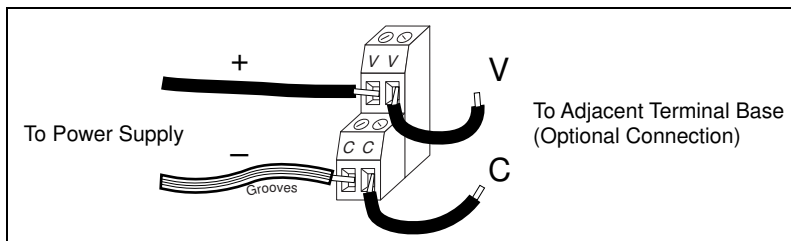

Figure 2-16. FP-1000/1001 Power Connector Pinout

The two terminals labeled V are internally connected on the network module, as are the two terminals labeled C. Power must be applied to one V and C pair for operation of the FieldPoint bank. If you want to power your field I/O devices from the same power supply, the second V and C pair provides a convenient means of connecting power to the V and C terminals of a terminal base. Figure 2-16 shows this optional connection.

If your field I/O devices need to be powered separately, you can use the terminals provided on each terminal base for such power supply connections. Refer to the documentation that came with your terminal base and I/O module for more information on powering your field I/O devices.

Calculating Power for a FieldPoint Bank

The power requirements for a FieldPoint bank that uses an FP-1000/1001 network module are calculated as follows:

$$\text{Power} = 1 \text{ watt} + 1.15 * \sum(\text{I/O Module Consumption})$$

This is the amount of power the network module consumes from the power supply to power itself and the I/O modules. It does not include any power consumed by devices that you wire to the terminal bases.

The operating instructions for each FieldPoint I/O module contain power consumption information.

Completed Hardware Installation

When power is applied, the **ACCESS** and **STATUS** LEDs should flash once, and the **POWER** LED should stay lit. The **POWER** and **READY** LEDs should be lit on all of the I/O modules. If these LEDs are not lit, check your power connections and make sure that all of your modules and terminal bases are firmly mated. If the **STATUS** LED is blinking, refer to Table 3-2, *STATUS LED Flashes and Corresponding Error Conditions*, in Chapter 3, *Feature Set Description*.

Feature Set Description

Chapter

3

This chapter describes the feature set for the FP-1000 and FP-1001 network modules.

High-Speed Local Bus

The FP-1000/1001 provides a high-speed local bus for communication to the I/O modules in the bank. The high-speed local bus has low overhead that enables fast response to commands from the host computer.

Network Watchdog Timer

The FP-1000/1001 can detect unexpected periods of network inactivity and respond to them in a user-defined way. The network watchdog timer feature enables you to guard your system against failures in the network connection, cables, or host computer, and to put the channel outputs in a user-defined state (the watchdog state) if such failures do occur.

You can set the watchdog output values to be different from the power-up output values. Some system applications do not differentiate between power-up output values and watchdog output values, while other applications treat the two conditions differently. The FP-1000/1001 supports both types of applications.

By default, the watchdog timer for the bank is disabled on power up. To use the watchdog timer, set up the following parameters. You can use either the FieldPoint Explorer software or the FieldPoint command set.

- Watchdog data value for each channel
- Watchdog data enable/disable status for each channel
- Watchdog enabled/disabled status for each I/O module
- Watchdog timeout value for the bank



Note: *Each bank has only one watchdog timeout value that is common for all the modules in that bank. In addition, the current watchdog timeout value is not stored when you store the SnapShot.*

SnapShot Feature

Many applications require that, upon startup, the system's I/O modules power up with user-specified configuration and output levels rather than factory default settings. The SnapShot feature provides you with a single-step method to store the current state of your FieldPoint bank for use as the power-up state of the bank.

If you subsequently enable the SnapShot feature, you can ensure that your system powers up with the configuration and output levels that you specified when storing the SnapShot.

Prior to storing the SnapShot, you should bring all the channels to the desired power-up settings. You can use either the FieldPoint Server software or the FieldPoint command set to change the configuration of the FieldPoint bank, and then store the SnapShot. The SnapShot stores all the following information in a single step:

- Attribute and range settings of each channel.
- Output values of each channel.
- Watchdog data values of each channel. See the [Network Watchdog Timer](#) section in this chapter for more information.
- Watchdog data enabled (or disabled) status for each channel. See the [Network Watchdog Timer](#) section in this chapter for more information.
- Watchdog enabled (or disabled) status of each module. See the [Network Watchdog Timer](#) section in this chapter for more information.

After you store the SnapShot information, you can still choose whether the FP-1000/1001 uses that stored information during future power-ups. Enable the SnapShot feature if you want the FieldPoint bank to power up with the stored SnapShot information.

If you have enabled the SnapShot feature, the FP-1000/1001 restores the stored settings to all I/O modules and channels in the bank every time you power up, until you disable the SnapShot feature. If the

SnapShot feature is disabled, the FieldPoint bank powers up with factory-default settings.

At some time you might want to change the stored SnapShot information. To make incremental changes in the stored SnapShot information, you can use the features described in the next section, *Programmable Power-Up State*.



Note: *The current watchdog timeout value for the FieldPoint bank is not saved when you store the SnapShot.*



Note: *The SnapShot feature inherently requires that the entire FieldPoint bank be at your desired power-up state, since when you store the SnapShot information, the current settings of the entire bank are stored for use at future power-ups.*

Programmable Power-Up State

The SnapShot feature described in the SnapShot section provides you with a single-step method to store the current state of the FieldPoint bank for use as the power-up state. The FP-1000/1001 provides an alternative method to define power-up states that allows you to store the SnapShot information with more flexibility, as described in this section.

The Programmable Power-Up State feature enables you to define the power-up configuration on a module-by-module basis. In addition, you do not need to actually set any of the channels to the desired power-up state. You can therefore define the power-up states regardless of the current settings of any channel of a module.

Optionally, you can utilize the Programmable Power-Up State feature to incrementally modify previously stored SnapShot information.

If you subsequently enable the SnapShot feature, you can ensure that your system powers up with the configuration and output levels that you specified when storing the Programmable Power-Up States.

You can use the Programmable Power-Up State feature to individually store the following information. You can use either the FieldPoint Explorer software or the FieldPoint command set.

- Attribute and range settings of each channel
- Output values of each channel
- Watchdog data value of each channel. See the *Network Watchdog Timer* section in this chapter for more information.
- Watchdog data enabled (or disabled) status for each channel. See the *Network Watchdog Timer* section in this chapter for more information.
- Watchdog timer enabled (or disabled) status of each module. See the *Network Watchdog Timer* section in this chapter for more information.
- Power-up watchdog timeout value for the FieldPoint bank
- The turn-around delay for each module
- The hot-swap reporting mode for the FieldPoint stack. See the next section, *HotPnP (Hot Plug and Play)*, for more information on the hot-swap reporting mode.

If you have enabled the SnapShot feature, the FP-1000/1001 restores your desired settings to all I/O modules and channels in the bank every time you power up, until you disable the SnapShot feature.

HotPnP (Hot Plug and Play)

The HotPnP feature simplifies system installation, configuration, and maintenance. With the HotPnP feature, you can remove or insert I/O modules into the FieldPoint terminal bases while power is on, even if the system is already engaged in network activity. You do not need to power down the entire system or even a bank to insert, remove, or replace I/O modules. In addition, you do not need to change the operation of the host computer or software to use the HotPnP feature.

When you insert an I/O module with the power on, it is automatically recognized, configured, and made available on the network. The following sections describe how the HotPnP feature works under different conditions.



Note: *You should not add or remove terminal bases while power is applied to the bank. An I/O module can be hot-inserted only if an empty terminal base is already available in the bank.*

HotPnP During Power-Up

Upon power-up, the FP-1000/1001 automatically uploads an electronic data sheet (EDS) from each I/O module in its bank. The FP-1000/1001 then configures each I/O module in the bank to factory default settings in the module's EDS, or stored SnapShot settings if the SnapShot feature is enabled.

HotPnP During Operation

You may need to insert or replace one or more I/O modules in a bank while your system is operational (power is on and the network may or may not be active).

Inserting New I/O Modules

When a new I/O module is inserted, the FP-1000/1001 automatically uploads the EDS and configures the I/O module to factory default settings in the module's EDS, or to stored SnapShot settings if the SnapShot feature is enabled. This configuration is accomplished without any intervention from the host computer or software.

While one or more new I/O modules in a bank are being serviced by the HotPnP feature, the other I/O modules in the bank remain fully operational and accessible on the network without any interruptions. As soon as the FP-1000/1001 configures the new I/O module via the HotPnP service, that I/O module becomes automatically accessible on the network.

Replacing I/O Modules

When an I/O module is removed, the FP-1000/1001 does not undertake any special course of action for the bank. The host computer (or the software executing on it) may be unaware that the I/O module is missing, and may continue to send commands to the missing I/O module. Each command returns an error response, but the FP-1000/1001 remembers the commands sent to the missing I/O module.

When a new I/O module is connected in place of the one that was removed, the FP-1000/1001 first verifies that the replacement I/O module is compatible with the one that was removed. If the I/O module is the same as, or is compatible with, the one removed, the FP-1000/1001 configures the replacement I/O module with its predecessor’s configuration and output value settings. It also applies the effects of any commands sent by the host computer while the I/O module was missing.

If the replacement module is incompatible with the one that was removed, the FP-1000/1001 looks at the information stored in the SnapShot. If the SnapShot is enabled and the replacement module is compatible with the information in the SnapShot, the FP-1000/1001 configures the replacement module with the SnapShot configuration. Otherwise, the FP-1000/1001 configures the replacement module to factory default settings.

Table 3-1 shows how modules are configured after HotPnP replacement.

Table 3-1. Module Configuration Results After HotPnP Replacement

SnapShot Feature	Replacement Module	Replacement Module Configuration After HotPnP
Enabled/ Disabled	Compatible with the removed module	Same as the configuration of the removed module
Disabled	Incompatible with the removed module	Factory default configuration of replacement module
Enabled	Incompatible with the removed module but compatible with the SnapShot information	Same as the configuration stored in the SnapShot
Enabled/ Disabled	Incompatible with the removed module and incompatible with the stored SnapShot information	Factory default configuration of replacement module

While one or more replacement I/O modules in the bank are being serviced by the HotPnP feature, the other I/O modules in the bank

remain fully operational and accessible on the network without any interruptions. As soon as the FP-1000/1001 configures a replacement I/O module via the HotPnP service, that I/O module becomes automatically accessible on the network.

Power-On Self Test (POST)

The power-on self test (POST) is a test suite that the FP-1000/1001 performs at power up to verify its own operational status. The test is non-invasive and therefore does not affect the operation of the network, nor does it affect any of your field wiring connected to the terminal bases in the bank.

If the self-test suite fails, the FP-1000/1001 does not participate in the network communication traffic, thereby eliminating potential conflicts with the other banks in your network.

The FP-1000/1001 indicates POST failure via the **STATUS** LED. Refer to the next section, *LED Indicators*, for more information.

LED Indicators

The FP-1000/1001 has four LED indicators: **POWER**, **NETWORK**, **ACCESS**, and **STATUS**. Figure 3-1 shows the LEDs on the FP-1000/1001.

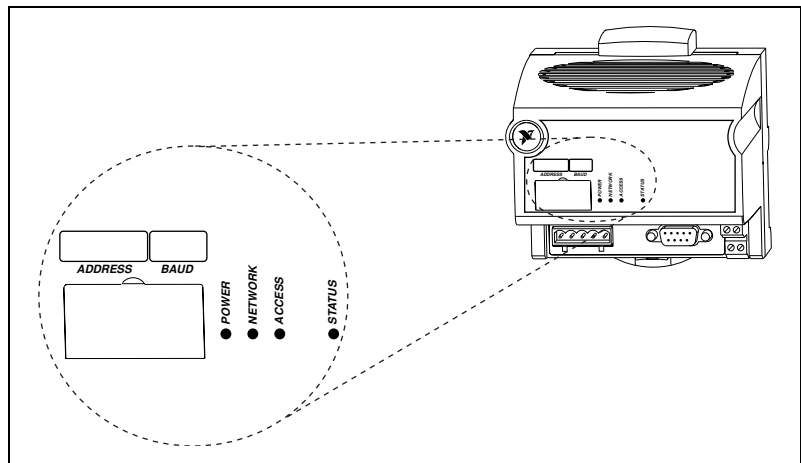

Figure 3-1. LEDs on the FP-1000/1001

The green **POWER** LED is lit while the FP-1000/1001 is powered up. This LED indicates that the power supply connected to the FP-1000/1001 is acceptable, and that the FP-1000/1001 is supplying power to the I/O modules.

The yellow **NETWORK** LED is lit during transmissions from the host computer on the network. This LED indicates that the FP-1000/1001 is receiving from the network, and that the communication wires to it are not broken. The **NETWORK** LED gets brighter as activity on the network increases.

The yellow **ACCESS** LED flashes when the FP-1000/1001 or any of the I/O modules in its bank respond to the host computer. This LED indicates that a module in the bank was addressed by a correctly formatted command, and that the module is responding to that command (either with a success or error response).

The red **STATUS** LED is lit when the FP-1000/1001 detects a failure. If **STATUS** is not lit, the FP-1000/1001 has not detected a failure. The FP-1000/1001 indicates specific error conditions by flashing **STATUS** a specific number of times. Table 3-2 describes the **STATUS** LED flashing sequences and the corresponding error condition.

Table 3-2. STATUS LED Flashes and Corresponding Error Conditions

Number of Flashes	Error Condition
0 (stays lit)	The FP-1000/1001 initialization failed.
1	The FP-1000/1001 address switch is incorrectly configured. Refer to the <i>Setting the Network Address</i> section in Chapter 2, <i>Hardware Installation and Configuration</i> .
2	The FP-1000/1001 has detected an error in the terminal bases in the bank or has identified a module in an illegal state. Verify that the protective cover is on the local bus connector of the last terminal base and that none of the pins of that connector are touching or bent.

Table 3-2. STATUS LED Flashes and Corresponding Error Conditions (Continued)

Number of Flashes	Error Condition
3	The FP-1000/1001 has detected an irrecoverable internal error with its firmware.
5	The network module was unable to locate an I/O module waiting to be configured. Verify that there are no more than nine terminal bases in the bank, and that no terminal bases were added to the bank while power was applied.

Installing and Using the FieldPoint Software

Chapter

4

This chapter describes how to use the FieldPoint hardware with various servers and software packages.

FieldPoint Software Overview

Your FieldPoint software includes a full-functioned configuration utility as well as server and driver software for easy integration into application software packages. These software components manage the low-level communications and hardware details, simplifying programmatic access of I/O channels. Version 1.6 of the FieldPoint software runs on Windows 95, Windows 98, and Windows NT 4.0 and later, and includes the following components:

- FieldPoint Explorer Configuration Utility
- Lookout Driver Class
- BridgeVIEW Server
- LabVIEW VIs
- LabWindows/CVI Functions
- OPC Server

You can download future versions of FieldPoint software from the National Instruments FTP site at [ftp.natinst.com/support/fieldpoint/Server](ftp://ftp.natinst.com/support/fieldpoint/Server).

FieldPoint Explorer Configuration Utility

FieldPoint Explorer is the configuration utility for FieldPoint hardware and software. You can use FieldPoint Explorer to accomplish the following tasks:

- Configure the characteristics and hardware of a FieldPoint device network
- Configure the tag name space and I/O items of the FieldPoint servers
- Write and read I/O values to and from the FieldPoint hardware

For more information on FieldPoint Explorer, refer to the [Using FieldPoint Explorer](#) section, later in this chapter.

BridgeVIEW Server

The BridgeVIEW server for FieldPoint provides communication between FieldPoint devices and applications you develop using the BridgeVIEW graphical programming package for automation. This native BridgeVIEW sever allows access to I/O items defined in the FieldPoint Explorer. If you prefer, you may also choose to use the OPC server to access FieldPoint hardware from BridgeVIEW.

For more information on the BridgeVIEW server, refer to the [Using the FieldPoint BridgeVIEW Server](#) section, later in this chapter.

Lookout Driver Class

The FieldPoint Lookout driver class allows the Lookout object-based automation software package to communicate with the FieldPoint devices. This driver class provides a FieldPoint object with connections to the tag name space of the I/O items configured in the FieldPoint Explorer.

For more information on the Lookout driver class, refer to the [Using the FieldPoint Lookout Driver Class](#) section, later in this chapter.

LabVIEW VIs

A set of VIs (Virtual Instruments) provide communication between I/O items configured in the FieldPoint Explorer and applications you develop using the LabVIEW graphical programming environment. A set of example applications using these VIs is also provided.

For more information on LabVIEW VIs, refer to the [Using the FieldPoint LabVIEW VIs](#) section, later in this chapter.

LabWindows/CVI Functions

Applications you develop using the LabWindows/CVI C programming environment use a set of C function calls to communicate with I/O items configured in the FieldPoint Explorer. An instrument driver with a set of function panels and example programs is provided to accelerate your development process.

For more information on LabWindows/CVI functions, refer to the [Using the FieldPoint LabWindows/CVI Functions](#) section, later in this chapter.

OPC Server

OPC (Object Linking and Embedding for Process Control) is an industry standard interface that uses Microsoft's Component Object Model (COM). The FieldPoint OPC server provides an interface to the I/O items configured in the FieldPoint Explorer and software packages that are capable of using OPC, including recent versions of Microsoft's Visual Basic and Visual C/C++ programming environments, and other third-party software packages.

For more information on the FieldPoint OPC Server, refer to the [Using the FieldPoint OPC Server](#) section, later in this chapter.

Other Options for Communicating with FieldPoint Devices

It is also possible to communicate with the FieldPoint system using an Optomux-compatible server, or by sending ASCII commands directly to and from the serial port of the host computer. Examples of cases where one of these methods may be useful include the following:

- Communicating with FieldPoint from a computer running an operating system other than Windows 95/98/NT
- Communicating with FieldPoint from a device such as a PLC; to integrate FieldPoint devices into an existing Optomux-based system
- Using a programming environment that does not support the OPC interface

If you choose one of these communication methods, refer to the *FP-1000/1001 Programmer Reference Manual* for details on the protocol used by the FieldPoint network modules. You may, however, still use the FieldPoint Explorer to configure the FieldPoint devices before running your software.

For more information on using FieldPoint with Optomux servers, refer to the [Using FieldPoint with an Optomux Server](#) section, later in this chapter.

Data Throughput with the FieldPoint Servers

The rate at which data can be transferred between a FieldPoint bank and a computer is determined by the number and type of I/O channels and the baud rate. You can download a calculator to determine the data throughput from [ftp.natinst.com/support/FieldPoint/server](ftp://ftp.natinst.com/support/FieldPoint/server). This calculator is available as both an Excel Spreadsheet and as a LabVIEW/BridgeVIEW VI.

Installing FieldPoint Software

Follow these steps to install your FieldPoint software:

1. If you are using BridgeVIEW, LabVIEW, Lookout, or LabWindows/CVI with FieldPoint, install these other application programs *before* installing your FieldPoint software. The FieldPoint software installation installs the BridgeVIEW server, LabVIEW VIs and examples, Lookout driver class, and LabWindows/CVI instrument driver only if it finds the corresponding application software installed.
2. Insert the *FieldPoint Configuration and Server Software* disk number 1 into the floppy drive on your computer.
3. Click on the Windows **Start** button, and then click on **Run**.
4. Enter `a:\setup`, where *a* is the letter of your floppy drive, then select **OK**.
5. Follow the onscreen instructions to complete the installation.



Note: *Do not worry if the installation program does not ask you to insert all of the disks. Depending on the software already installed on your computer, you may not need to use all of the disks that you received.*

Using FieldPoint Explorer

The FieldPoint Explorer is the configuration software for FieldPoint hardware and software. The first step to using FieldPoint software is to run the FieldPoint Explorer. You then use FieldPoint Explorer to configure the programmable settings of the FieldPoint hardware, such as the input range of an analog input module, or watchdog timer settings, or the power-up values of output modules. From FieldPoint Explorer you define *I/O items* (which represent one or more physical I/O channels) that you want to write to or read from. FieldPoint Explorer also provides a user interface from which you can interactively

read and write values of these I/O items to verify that your FieldPoint system has been correctly installed and configured.

Figure 4-1 shows the parts of the FieldPoint Explorer window.

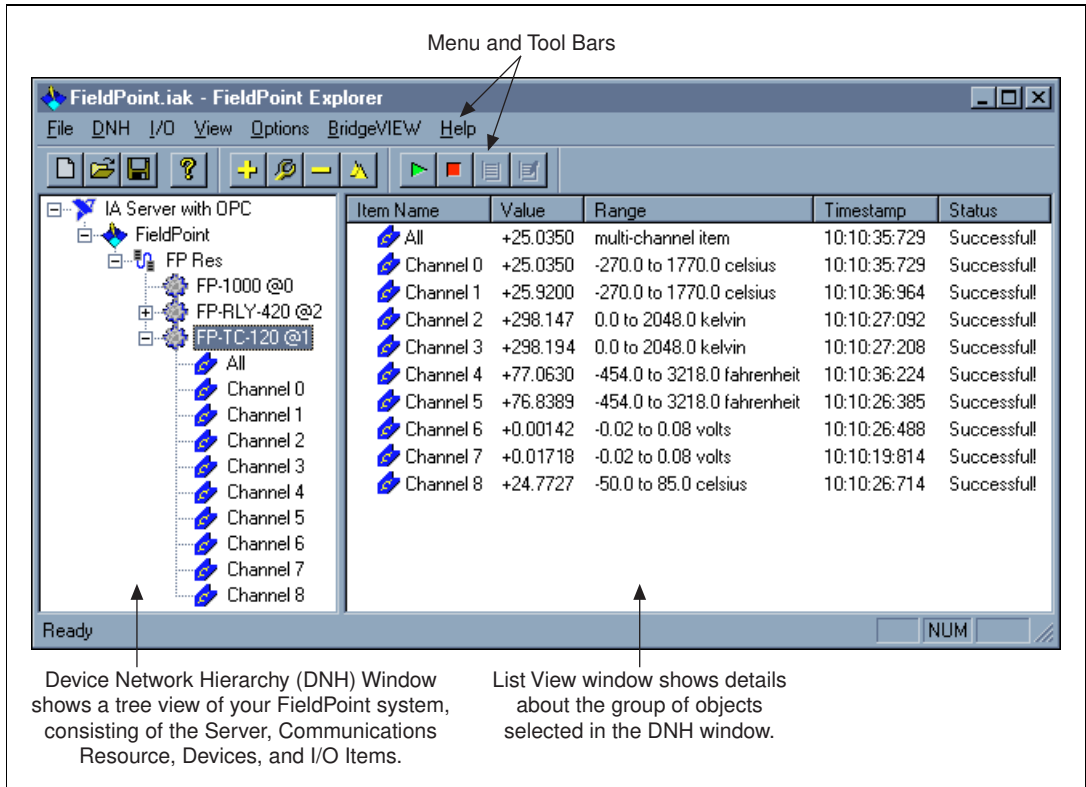

Figure 4-1. FieldPoint Explorer Window

Getting Assistance While You Work

FieldPoint Explorer includes several features to help answer your questions about using the software and to reduce the time you spend learning how to use and get the most out of FieldPoint Explorer. These features include *ToolTips*, *ScreenTips*, and *online help*.

ToolTips identify tool bar icons and most items on the screen. Rest your pointer over the element you are interested in, and its name appears, as shown in Figure 4-2.

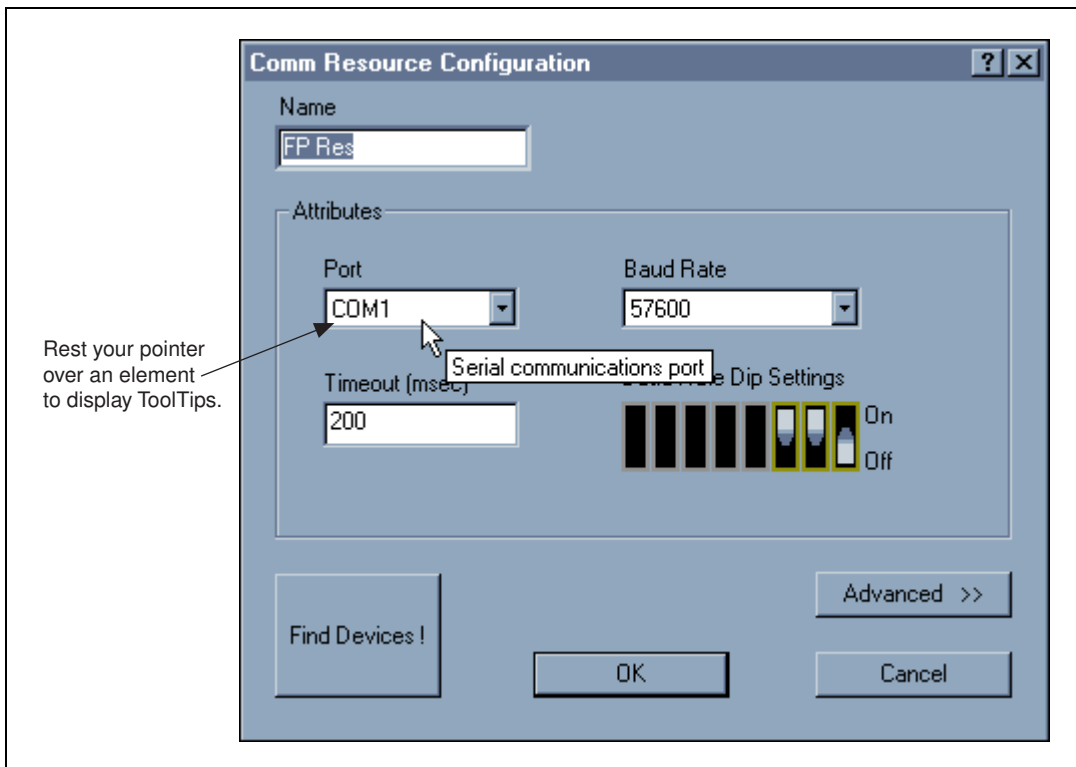

Figure 4-2. ToolTips Showing the Name of an Item

ScreenTips provide descriptions of the items in a dialog box to help explain what the item does or how you should use it. Display ScreenTips by clicking the question mark button in the title bar of the dialog box and then clicking the item you want to know more about. The ScreenTip appears as shown in Figure 4-3.

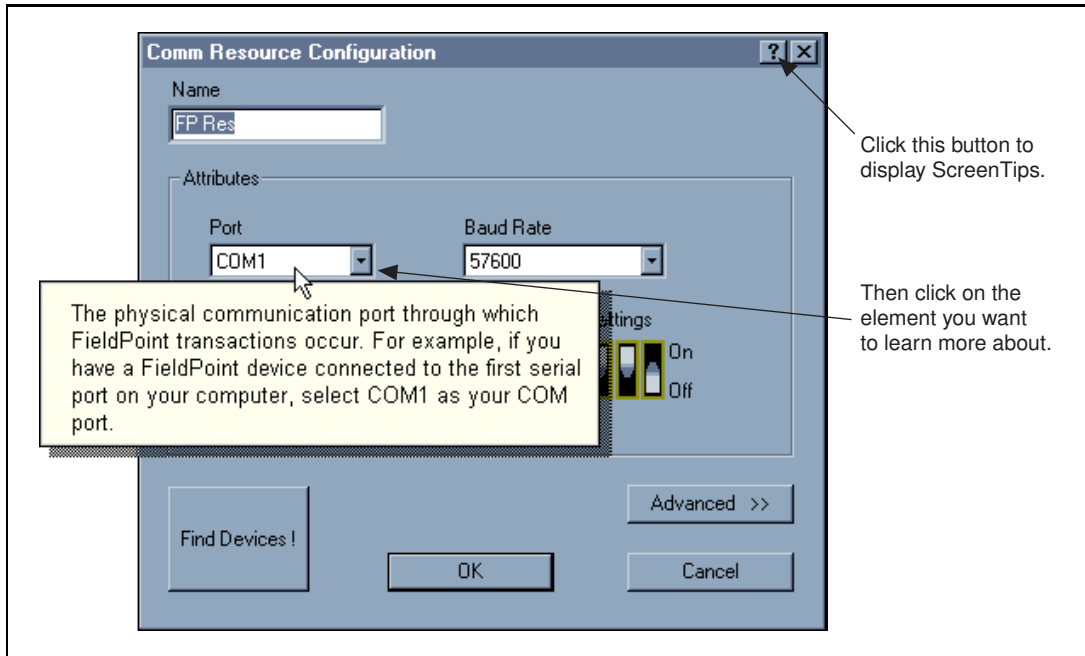

Figure 4-3. ScreenTips Showing a Description of an Item

The FieldPoint online help provides complete descriptions of the features of FieldPoint Explorer and provides assistance in getting started with configuring your FieldPoint hardware and software. Open the online help by selecting the **Contents** option in the **Help** menu of FieldPoint Explorer.

Getting Started with FieldPoint Explorer

This section guides you through an example of how to configure a FieldPoint system. The online help provides more details and explains all of the features of FieldPoint Explorer.

To get started with FieldPoint Explorer, follow these steps:

1. Install the hardware as described in Chapter 2, *Hardware Installation and Configuration*. Verify that the FieldPoint system is powered on and the I/O modules have their **READY** LEDs lit.
2. From the Windows **Start** menu, select **Programs»FieldPoint»FieldPoint Explorer** to launch the FieldPoint Explorer program.
3. Add a communications resource to the Device Network Hierarchy. To add the resource, first click on the + sign next to **IA Server with**

OPC in the DNH window to expand the view. Then right-click on the word **FieldPoint** and select **Add a comm resource to this server**. The communications resource dialog box appears as shown in Figure 4-4.

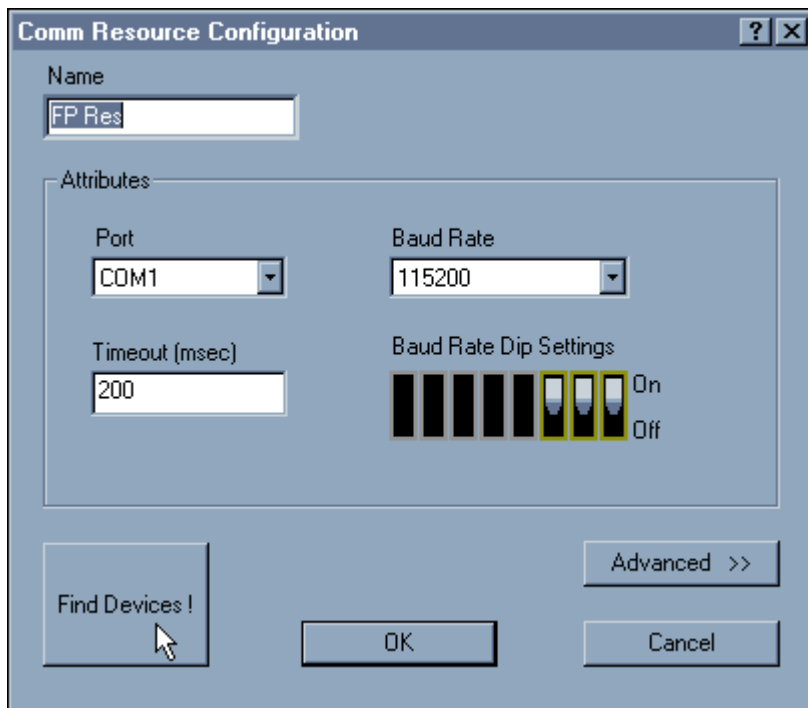

Figure 4-4. Communication Resource Configuration Window

4. Select the COM port on your computer that you cabled the FieldPoint system to.

The FP-1000/1001 network module is preconfigured for a baud rate of 115200 kbps, so you should not have to change the baud rate or timeout setting in the dialog box unless you have modified the baud rate switches on the network module. The default name for the COM port you select is **FP Res**.

5. Click on the **Find Devices!** button to start searching for all of the FieldPoint Devices on this communications resource. If no devices are found, make sure that the FieldPoint hardware is powered on, that the switch settings for the baud rate match the settings on the network module, and that no two network modules on the same communications port have the same address switch settings. Also

make sure that you have selected the COM port to which you have connected the FieldPoint system. If FieldPoint Explorer reports that it cannot bind the COM port, make sure that you have selected a COM port that is properly configured in your computer and is not being used by any other program.

6. After the FieldPoint modules are found, click on the + sign next to **FP Res** in the DNH window to expand the device hierarchy and display the modules found on the network.

The hierarchy should include all of the modules you had connected to the communications port. Figure 4-1 shows an example of an expanded device hierarchy. The default name of each device found includes the model number of the FieldPoint module, followed by the @ sign, then the address of the module—for example, “FP-1000 @0”. For each I/O module found, one I/O Item is created for each channel of the module, and one I/O Item is created to represent all of the channels on that module collectively.

7. To configure the hardware settings of a particular I/O module, select the device in the DNH window.
 - a. Right-click on the device name and select **Edit the device** from the pop-up menu.
 - b. Click on the **Channel Configuration** button to bring up the channel configuration dialog box shown in Figure 4-5. In this example, an FP-TC-120 thermocouple module was selected to configure.
 - c. To configure a channel, select the channel in the **Channel Number** list.
 - d. Set the attributes of this channel from the **Attributes** tab by selecting the desired **Attribute Value** from the list.
 - e. Set the data range for this channel by clicking on the **Ranges** tab and selecting the range from the list.
 - f. Continue this for each channel in the **Channel Number** list that you want to configure.
 - g. Click the **OK** button when you are finished.
 - h. Click the **Yes** button when asked if you want to write these settings to the device.

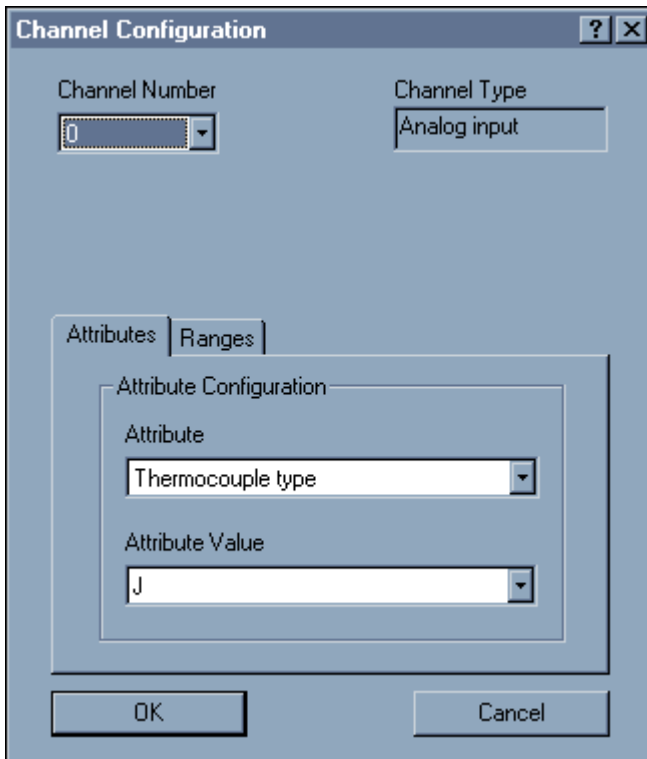

Figure 4-5. Channel Configuration Dialog Box

8. You can now try to read from the FieldPoint devices that you have configured. Select one of the devices in the DNH window, and then click on the **Start Monitoring** button (green arrow icon) in the Tool Bar to start monitoring the items of that device.

The tag symbols of the items in the list view window turn blue to show that they are being monitored. The **Value** column in the list view window should show the current value of the I/O channels defined by the I/O Items, and the **Status** column shows any error conditions received while communicating with the FieldPoint network.

9. Click on the **Stop Monitoring** button (red square icon) in the toolbar to stop monitoring the items.
10. You can also write to output channels of I/O Items that you have configured.
 - a. Select a device in the DNH window with output channels.

- b. Select the I/O Item in the list view window corresponding to the channel you want to write to.
 - c. Click on the **Write Value** button (pen and paper icon) in the toolbar to write to the I/O channel(s) represented by the I/O Item.
 - d. Enter the value you want to write in the **Value** box and click on the **Write!** Button to write the value out. The value must be in the range of the channel that you configured in Step 7. For example, if the channel was configured for a range of 0.0035 A to 0.021 A, and you want to write a value of 0.010 A (10 mA), enter 0.010 in the **Value** box. For discrete I/O channels with a Boolean range, enter a 1 or a 0 in the **Value** box.
11. When you are satisfied with the hardware configuration of your FieldPoint system, you may choose to save this configuration as the new power-up state for the hardware.
 - a. Edit the device configuration of the FP-1000/1001 network module by right-clicking on the network module entry in the DNH window.
 - b. Select **Edit this device** from the pop-up menu.
 - c. Make sure that the **factory configuration** checkbox is not checked.
 - d. If you only want the range and attribute settings you configured in Step 7 to be saved as power-up states, you can just click on the **OK** button, because these settings get written to the non-volatile memory of the network module when you write changes to the device in Step 7.
 - e. If you also want to save all of the current output states of the output channels, click the **Snapshot!** button to store all of the output values of that bank of FieldPoint modules to the power-up memory of the network module, then click the **OK** button when you are finished.
 12. When you are finished configuring the hardware settings and the I/O items, you must save your configuration file. Select **File»Save** from the menu bar.
 13. Exit the FieldPoint Explorer application.

**Note:**

You must exit FieldPoint Explorer before you can communicate with the FieldPoint system using one of the methods described in the subsequent sections.

Using the FieldPoint BridgeVIEW Server

The FieldPoint BridgeVIEW server is a device server based on the native BridgeVIEW server architecture. The I/O Items you configured in the FieldPoint Explorer become available to the BridgeVIEW server when you export the configuration data from FieldPoint Explorer into the BridgeVIEW common configuration database (CCDB). From within BridgeVIEW, the Tag Configuration Wizard imports this configuration information, creating a tag for every I/O Item you configured in the FieldPoint Explorer. These tags are immediately accessible through the BridgeVIEW real-time database.

To start using the FieldPoint server with BridgeVIEW, follow these steps:

1. Configure and test your FieldPoint server from FieldPoint Explorer, as described in the *Using FieldPoint Explorer* section of this chapter, and save your configuration file.
2. Select the **BridgeVIEW»Export to BridgeVIEW** option from the menu bar of FieldPoint Explorer to export the current configuration file that you just saved to BridgeVIEW's active CCDB. (If BridgeVIEW is not an option on your FieldPoint Explorer's menu bar, make sure that you have installed the FieldPoint software after installing BridgeVIEW.)



Note: *If you edit, rename, or move your configuration file after you export it to the BridgeVIEW Active CCDB, you must re-export the new configuration file. If you select another CCDB file as the Active CCDB for BridgeVIEW, you must re-export your FieldPoint configuration file to the newly selected Active CCDB file.*

3. Exit FieldPoint Explorer.



Note: *You must exit FieldPoint Explorer before you can use the FieldPoint server from BridgeVIEW.*

4. Launch BridgeVIEW and load the Tag Configuration Editor by selecting **Project»Tag»Configuration** from the menu bar of a BridgeVIEW window, or click on the **Configure Tags** button of BridgeVIEW's initial tile screen.
5. Click on the **Configuration Wizard** button in the lower-right corner of the Tag Configuration Editor window, and then select **FieldPoint** from the list of servers that appears.

All of the FieldPoint I/O Items in your configuration file are automatically imported as tags into BridgeVIEW and are now accessible through the BridgeVIEW real-time database. Do not worry if you get a message that no tags were created for the network modules in your system, as they do not have any I/O items.

6. You may edit the tags to change their names, scaling information, and other parameters.

Refer to your BridgeVIEW documentation for more information about tags and their configuration. Hint: the Tag Configuration Editor may be easier to read for FieldPoint tags if you change the middle column heading from **Tag Group** to **Item**.

7. When you have finished editing the tags (or if you chose to keep the default settings for the tags), exit the Tag Configuration Editor and save the changes to the configuration file.

You can now access the FieldPoint I/O Items by reading or writing these tags as you would any other tag in BridgeVIEW.

Using the FieldPoint Lookout Driver Class

When you install the FieldPoint software, a FieldPoint driver class is created if Lookout has already been installed on your computer. When you create a FieldPoint object within Lookout, you specify the configuration file created by FieldPoint Explorer. The FieldPoint object you create uses this configuration file to import the information about the I/O items that you had configured within FieldPoint Explorer. All of these I/O Items are immediately accessible as writable and/or readable data members.

To start using the FieldPoint Lookout driver class, follow these steps:

1. Configure and test your FieldPoint server from FieldPoint Explorer, as described in the *Using FieldPoint Explorer* section of this chapter, and save your configuration file.
2. Exit FieldPoint Explorer.



Note: *You must exit FieldPoint Explorer before you can use the FieldPoint driver class from Lookout.*

3. Start Lookout, and create a new control panel or open an existing one.

4. Select **Object»Create** from the menu bar and choose the FieldPoint object class from the **Drivers** category of the **Select Object Class** dialog box. The **Create FieldPoint Secondary** dialog box shown in Figure 4-6 appears.

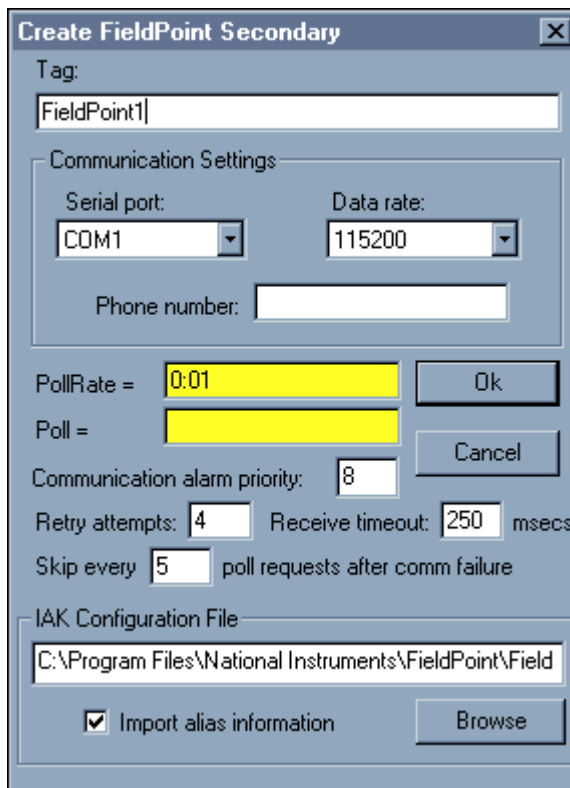

Figure 4-6. Creating the FieldPoint Object

5. Create your object.
 - a. Select the serial port you are using and the data rate (baud rate) in the **Communication Settings** area of the dialog box.
 - b. Enter the path of the configuration file you saved from FieldPoint Explorer in the **IAK Configuration File** area, and make sure the **Import alias information** box is checked. (You can use the **Browse** button to find the configuration file you saved.)
 - c. Make any changes you want to make to the poll rate or other parameters, and click on the **OK** button.

Your FieldPoint object is now created, and all of the I/O Items you configured in FieldPoint Explorer are available as data members of the object.

- To verify that the data members were properly imported from your configuration file, or to modify the parameters of the data members, select **Object»Edit Database** from the menu bar, and double-click on the FieldPoint object you just created. An object database window like the one in Figure 4-7 appears.

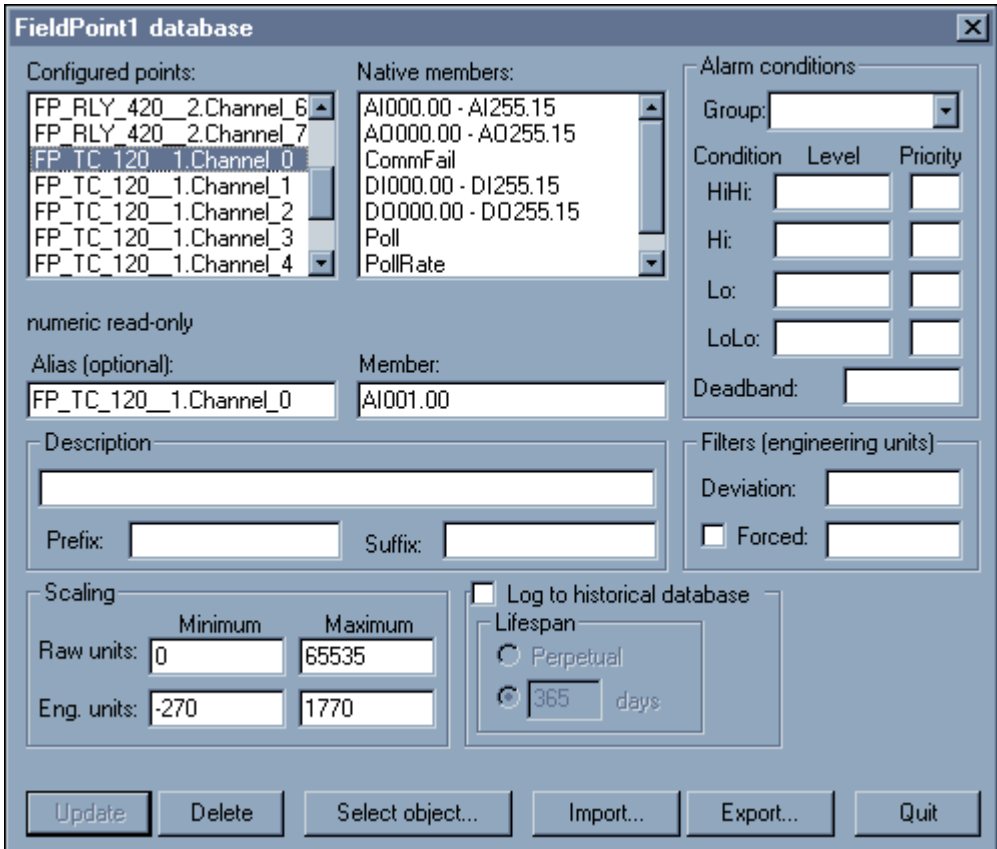

Figure 4-7. Modifying the FieldPoint Data Members

The **Configured Points** list should contain all of the I/O Items you configured in FieldPoint Explorer. The **Eng. units** in the scaling window indicate the configured range of analog I/O Items. From this window, you can modify the alias, alarm conditions, and other parameters of each data member in the FieldPoint object.

For more information about the FieldPoint driver object class and data members, refer to the *National Instruments FieldPoint* section of Chapter 18, *Object Class Reference*, in your *Lookout Reference Manual*.

Using the FieldPoint LabVIEW VIs

When you install the FieldPoint software, a library of FieldPoint VIs is created if LabVIEW has already been installed on your computer. The FieldPoint VIs (FP Open, FP Get Configuration Info, FP Create Tag, FP Advise, FP Read, FP Write, and FP Close) directly access the I/O Items you configured in the FieldPoint Explorer program. In addition, a set of examples is placed in your `LabVIEW Examples` directory. These examples are the best way to get familiar with the LabVIEW VIs. The **FieldPoint LabVIEW Help** document is in the same program group on your Windows taskbar as the FieldPoint Explorer program. This help document explains how to use the FieldPoint VIs.

A simple FieldPoint application to read an I/O Item may only need to use four of the VIs. To create an example of such an application, complete the following steps and refer to Figures 4-8 and 4-9. This application reads the inputs from the I/O Item named **All** shown in Figure 4-1.

1. Use FP Open to open the server. By default, the server opens with the configuration file you last saved with FieldPoint Explorer.
2. Use FP Create Tag to create a handle to an I/O Item that you defined in FieldPoint Explorer. You provide three string names to this VI to indicate which I/O Item you want access to. These three strings are the names given to the communications resource, the device, and the I/O item. Figure 4-7 shows default names as they may appear when you use the **Find Devices** button in FieldPoint Explorer.
3. Use FP Advise to continuously monitor the I/O Item at the rate specified in FieldPoint Explorer. (You may also set a new rate with this VI.) In this example, the while loop executes at this advise rate. If you used FP Read VI here instead of FP Advise, the loop would *free-run* at the fastest rate it could sustain, reading the I/O Item over the serial port each time the loop ran.



Note:

You should not put more than one FP Advise VI in a loop. All VIs in a loop execute only once each time a loop runs, and FP Advise VIs only complete at their advise rate. If you had more than one FP Advise VI in the loop, the loop (and therefore all of the FP Advise VIs in the loop) would only execute

at the slowest rate of the Advises. The loop may not execute at all if any of the Advises is set to complete “On Data Change”, and the data of the corresponding I/O Item never changed.

4. Use FP Close to close the server. This action also stops all pending Advise operations.



Note: *This example reads the value of an I/O Item value from the FieldPoint device. To write to an Output Item, use FP Write instead of FP Advise (or FP Read).*

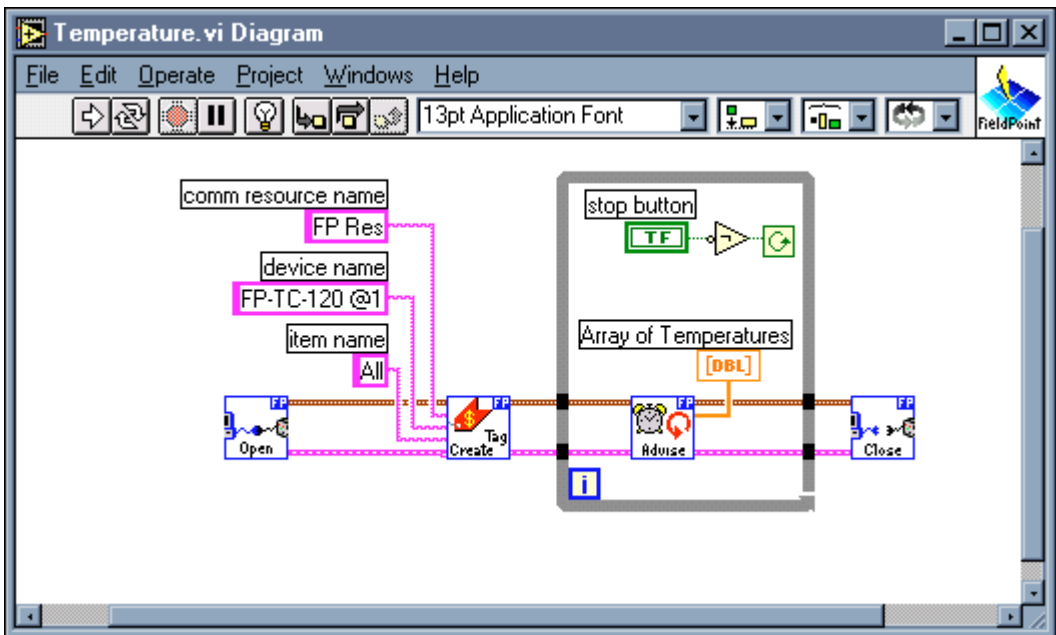

Figure 4-8. LabVIEW Diagram for LabVIEW Example Application

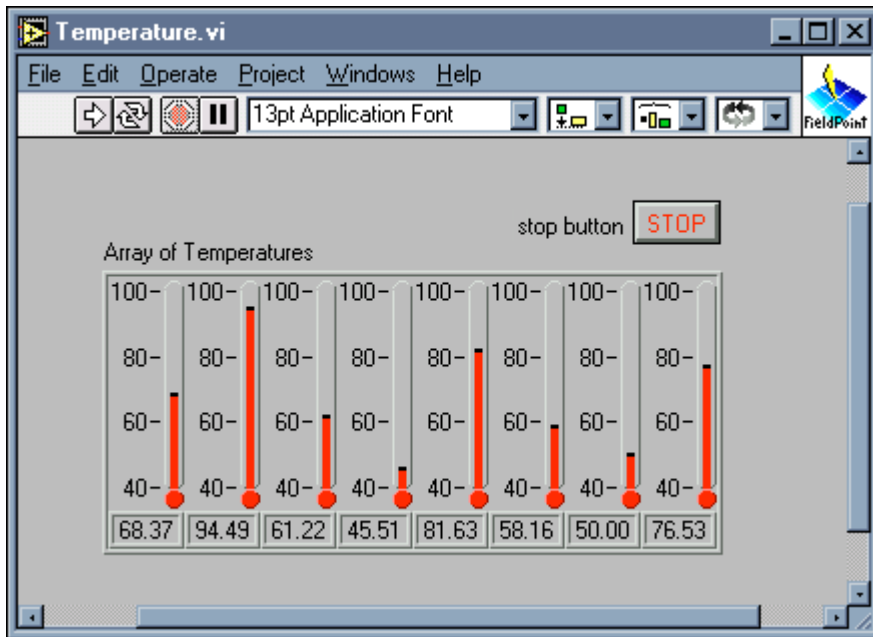

Figure 4-9. Front Panel for LabVIEW Example Application

Using the FieldPoint LabWindows/CVI Functions

When you install the FieldPoint software, a LabWindows/CVI instrument driver for FieldPoint is created if LabWindows/CVI has already been installed on your computer. This instrument driver includes function panels to call C functions that directly access the I/O Items you configured in the FieldPoint Explorer program. In addition, a set of sample projects is placed in your LabWindows/CVI Samples directory. These examples are the best way to get familiar with these functions. The FieldPoint CVI Help document is in the same program group on your Windows taskbar as the FieldPoint Explorer program. This help document describes each function in the instrument driver with a description of the C syntax, a description of each parameter, and a list of possible error codes.



Note:

FieldPoint CVI Interface Compatibility Modes: The FieldPoint software ships with object (.obj) files to support the different compiler compatibility modes that LabWindows/CVI supports (Microsoft Visual C/C++, Borland, Watcom, and Symantec). When FieldPoint software is installed, the Microsoft compatibility mode is installed by default. To use an alternate

compatibility, copy the supplied .obj file from the compiler folder (for instance, /CVI/FieldPoint/borland/FieldPoint.obj) with which you would like compatibility to the /FieldPoint subdirectory of the CVI directory.

Using the FieldPoint OPC Server

OPC (OLE for Process Control) is an industry standard device interface specification that provides interoperability between field devices such as FieldPoint and application software packages. The FieldPoint OPC server, like the other FieldPoint interfaces, imports the I/O Items that you configured in FieldPoint Explorer and makes them available as OPC Items to an *OPC client*, a software program designed to communicate with OPC servers. The FieldPoint OPC server allows any application written as an OPC client to access the FieldPoint hardware over the serial port. Because OPC is based in part on Microsoft's DCOM (Distributed Component Object Model), it is even possible for an OPC client on one computer to access FieldPoint hardware connected to the serial port of another computer if the two computers are networked together.

OPC clients may differ in the features they offer and their presentation of the OPC interface for the FieldPoint OPC server. You should refer to the documentation on using the OPC client features of your application for detailed instructions on how to access an OPC server. However, the basics steps involved are similar for most OPC client applications.

Follow these steps to start using the FieldPoint OPC server:

1. Open the FieldPoint OPC server, `National Instruments.OPCFieldPoint`.

This server was registered with Windows when you installed the FieldPoint software. OPC Clients should be able to show you a list of available registered servers, but you may have to type this name in yourself. The OPC client may automatically connect to the server when you select it, but if you are given the option to explicitly connect to the FieldPoint OPC server, you should do so.

2. Create a group.

Groups are a collection of I/O items. Some OPC clients may not give you the option of creating groups, or they may be created for you.

3. Select the I/O Items, which you configured in FieldPoint Explorer, that you want to read or write as a part of this group.

Many OPC clients can use the “Browse Address Space” feature of the FieldPoint OPC Server to show you a list of all of the I/O Items you configured in FieldPoint Explorer. However, if the OPC client you are using does not support this feature, you may need to type the Item IDs of the I/O Items directly. The naming convention of the FieldPoint Item IDs is `[Comm resource name]\[Device Name]\[I/O Item name]` where the Comm resource, Device, and I/O Item names are the names given in FieldPoint Explorer. For example, an Item ID associated with one of the I/O Items shown in Figure 4-1 would be `FP Res\FP-TC-120 @1\Channel 0`.

In most cases, the preceding steps are all that is required to configure an OPC client to read from I/O items of the FieldPoint OPC server. In some cases, the OPC client may require more information about the FieldPoint OPC server. The following list contains additional information about the FieldPoint OPC server, which you may find helpful.

- The FieldPoint OPC Server does not require an *Access Path*. Some OPC clients may expect the access path to be included in the Item ID name or may request the access path when you select I/O Items. You should be able to leave the access path blank (empty string).
- The FieldPoint OPC custom interface is an out of process server.
- The FieldPoint OPC Server supports both synchronous and asynchronous reads and writes.
- The FieldPoint OPC Server uses the “GetErrorString” method to return error and diagnostic messages from the FieldPoint server and hardware. OPC clients that do not support this method may only give you error messages like “Bad, non-specific” along with an error code. Some OPC clients that do not support this “GetErrorString” method may still provide a way for you to manually look up the FieldPoint message corresponding to the error code using the method.

Using FieldPoint with an Optomux Server

The FP-1000/1001 supports many of the commands of the standard Optomux protocol, so it is possible to communicate with the FieldPoint hardware using an Optomux server. This may be appropriate for an application where you are integrating FieldPoint into a system that is already using an Optomux server, or if you are using FieldPoint with an operating system not compatible with the other software options provided with your FieldPoint software. (The FieldPoint software does not include a generic Optomux server.) The *FP-1000/1001 Programmer Reference Manual* has detailed information on the protocol used by the FP-1000/1001, including which standard Optomux commands are supported and which are not. It is also a reference for working with the ASCII protocol directly. However, a general overview of using FieldPoint with Optomux servers is provided here as a guide.

- Standard Optomux commands do not allow for the configuration of hardware settings, so you must use FieldPoint Explorer to set your hardware settings (such as are set in Step 7 in the *Getting Started with FieldPoint Explorer* section, earlier in this chapter). If you make these settings the default power-up settings for the hardware (as described in Step 10 of that section), the FP-1000/1001 network module always powers up the I/O modules to these settings, so you do not need to run the FieldPoint Explorer more than once to configure your network module.
- The Optomux address of the FP-1000/1001 network module is the network address set by the switches as described in Table 2-1, *Network Address Switch Settings for the FP-1000/1001*, in Chapter 2, *Hardware Installation and Configuration*. The Optomux address of the I/O module in the first terminal base attached to the network module is one plus the address of the network module, and so on. In most cases you do not need to communicate with the network module, expect perhaps to change watchdog timer settings.
- Optomux analog data contains only 12 bits of resolution and is usually represented as an integer from 0 to 4095. Data that is returned from a FieldPoint analog channel has its minimum value represented by 0 and its maximum value represented by 4095. In some cases Optomux data may be represented by integers from 4096 (representing the minimum value of an analog channel) to 8191 (representing the maximum value of an analog channel).

- The standard Optomux protocol is not capable of returning the full range of error and diagnostic features supported by FieldPoint modules.
- If you are writing your own server, sending and receiving messages directly using the serial port, you are highly encouraged to use the extended FieldPoint command set as described in the *FP-1000/1001 Programmer Reference Manual* to get the most out of your FieldPoint hardware. Examples of programs that directly access the serial port to communicate with the FieldPoint network modules are available on the National Instruments FTP site at <ftp.natinst.com/support/fieldpoint/Examples/>.

Specifications

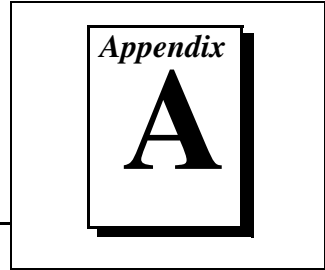

This appendix describes the specifications of the FP-1000 and FP-1001 network modules.

All FieldPoint network modules undergo extensive testing for operating under rugged environmental conditions that exist in industrial applications. FieldPoint network modules are designed and tested for immunity and susceptibility, as well as for emissions.

Network

FP-1000	1 RS-232 port, 1 RS-485 repeater port
FP-1001	1 RS-485 port
Baud Rates	300, 1200, 2400, 9600, 19200, 38400, 57600, 115200 (switch-settable)
Communication Parameters	1 start bit, 8 data bits, 1 stop bit, no parity
Integrity	Checksum
Cabling Distance from Host*	
FP-1000	50 ft. (nominal)*
FP-1001	4000 ft. (nominal)*
* Refer to the <i>RS-232 Interface Specifications</i> and <i>RS-485 Interface Specifications</i> sections in Chapter 2, <i>Hardware Installation and Configuration</i> .	
Power Supply Range	11 to 30 VDC
Power Consumption	1 watt + 1.15 * $\sum(I/O \text{ Module Consumption})$
Maximum Terminal Bases per Bank ...	9

Maximum Number of Banks	25
RS-232/RS-485 Interface Chips	15 kV ESD, low noise and slew rate, limited interface ICs
RS-485 Isolation	2500 Vrms breakdown, 250 Vrms operational

Environment

Operating Temperature.....	-40° to +70° C
Storage Temperature	-55° to +90° C
Relative Humidity	5% to 90% noncondensing

Compliance

Electrical Safety	designed to meet IEC 1010
EMI Emissions/Immunity.....	CISPR 11

Customer Communication

Appendix

B

For your convenience, this appendix contains forms to help you gather the information necessary to help us solve your technical problems and a form you can use to comment on the product documentation. When you contact us, we need the information on the Technical Support Form and the configuration form, if your manual contains one, about your system configuration to answer your questions as quickly as possible.

National Instruments has technical assistance through electronic, fax, and telephone systems to quickly provide the information you need. Our electronic services include a bulletin board service, an FTP site, a fax-on-demand system, and e-mail support. If you have a hardware or software problem, first try the electronic support systems. If the information available on these systems does not answer your questions, we offer fax and telephone support through our technical support centers, which are staffed by applications engineers.

Electronic Services

Bulletin Board Support

National Instruments has BBS and FTP sites dedicated for 24-hour support with a collection of files and documents to answer most common customer questions. From these sites, you can also download the latest instrument drivers, updates, and example programs. For recorded instructions on how to use the bulletin board and FTP services and for BBS automated information, call 512 795 6990. You can access these services at:

United States: 512 794 5422

Up to 14,400 baud, 8 data bits, 1 stop bit, no parity

United Kingdom: 01635 551422

Up to 9,600 baud, 8 data bits, 1 stop bit, no parity

France: 01 48 65 15 59

Up to 9,600 baud, 8 data bits, 1 stop bit, no parity

FTP Support

To access our FTP site, log on to our Internet host, `ftp.natinst.com`, as anonymous and use your Internet address, such as `joesmith@anywhere.com`, as your password. The support files and documents are located in the `/support` directories.

Fax-on-Demand Support

Fax-on-Demand is a 24-hour information retrieval system containing a library of documents on a wide range of technical information. You can access Fax-on-Demand from a touch-tone telephone at 512 418 1111.

E-Mail Support (Currently USA Only)

You can submit technical support questions to the applications engineering team through e-mail at the Internet address listed below. Remember to include your name, address, and phone number so we can contact you with solutions and suggestions.

support@natinst.com

Telephone and Fax Support

National Instruments has branch offices all over the world. Use the list below to find the technical support number for your country. If there is no National Instruments office in your country, contact the source from which you purchased your software to obtain support.

Country	Telephone	Fax
Australia	03 9879 5166	03 9879 6277
Austria	0662 45 79 90 0	0662 45 79 90 19
Belgium	02 757 00 20	02 757 03 11
Brazil	011 288 3336	011 288 8528
Canada (Ontario)	905 785 0085	905 785 0086
Canada (Québec)	514 694 8521	514 694 4399
Denmark	45 76 26 00	45 76 26 02
Finland	09 725 725 11	09 725 725 55
France	01 48 14 24 24	01 48 14 24 14
Germany	089 741 31 30	089 714 60 35
Hong Kong	2645 3186	2686 8505
Israel	03 6120092	03 6120095
Italy	02 413091	02 41309215
Japan	03 5472 2970	03 5472 2977
Korea	02 596 7456	02 596 7455
Mexico	5 520 2635	5 520 3282
Netherlands	0348 433466	0348 430673
Norway	32 84 84 00	32 84 86 00
Singapore	2265886	2265887
Spain	91 640 0085	91 640 0533
Sweden	08 730 49 70	08 730 43 70
Switzerland	056 200 51 51	056 200 51 55
Taiwan	02 377 1200	02 737 4644
United Kingdom	01635 523545	01635 523154
United States	512 795 8248	512 794 5678

FieldPoint System Configuration Form

Record the settings and revisions of your hardware and software on the line to the right of each item. Complete a new copy of this form each time you revise your software or hardware configuration, and use this form as a reference for your current configuration. Completing this form accurately also helps us to answer your questions more efficiently.

Host Computer

Computer brand _____ Model _____ Processor _____

Operating system (include version number) _____

Clock speed _____MHz RAM _____MB Display adapter _____

Mouse ___yes ___no Mouse type _____

National Instruments application software product _____ Version _____

Other application software product _____ Version _____

National Instruments server _____ Version _____

Other installed software that may use serial ports _____

Serial adapter (COM port or adapter card) used _____

Configuration _____

Serial driver _____ Version _____

Configuration _____

Serial port timeout value _____ ms

Number of FieldPoint banks _____

COM Port Number	Baud Rate	Data Bits/Stop Bits/Parity	Serial Hardware That Uses This Port	TX/RX FIFOs

FieldPoint Software

List the applications and/or servers that you are using with the FieldPoint hardware _____

FieldPoint Banks

Please use one page per FieldPoint bank.

Network module _____ Firmware revision _____

Address _____ Baud rate _____

Circle the state of the following items when your problem occurs:

LEDs POWER: ON/OFF NETWORK: ON/OFF ACCESS: ON/OFF STATUS: ON/OFF

SnapShot feature Enabled/Disabled

Watchdog timer Enabled/Disabled Timeout value _____ ms

Number of FieldPoint terminal bases _____

Number of FieldPoint I/O modules _____

Base #	Module Name*	POWER LED	READY LED	Module Configuration Information
0	FP-1000/1001	ON/OFF	ON/OFF	
1		ON/OFF	ON/OFF	
2		ON/OFF	ON/OFF	
3		ON/OFF	ON/OFF	
4		ON/OFF	ON/OFF	
5		ON/OFF	ON/OFF	
6		ON/OFF	ON/OFF	
7		ON/OFF	ON/OFF	
8		ON/OFF	ON/OFF	
9		ON/OFF	ON/OFF	

* If a terminal base is present but no module is inserted, write "none."

Technical Support Form

Photocopy this form and update it each time you make changes to your software or hardware, and use the completed copy of this form as a reference for your current configuration. Completing this form accurately before contacting National Instruments for technical support helps our applications engineers answer your questions more efficiently.

If you are using any National Instruments hardware or software products related to this problem, include the configuration forms from their user manuals. Include additional pages if necessary.

Name _____

Company _____

Address _____

Fax (____) _____ Phone (____) _____

Computer brand _____ Model _____ Processor _____

Operating system (include version number) _____

Clock speed _____ MHz RAM _____ MB Display adapter _____

Mouse ___ yes ___ no Other adapters installed _____

Hard disk capacity _____ MB Brand _____

Instruments used _____

National Instruments hardware product model _____ Revision _____

Configuration _____

National Instruments software product _____ Version _____

Configuration _____

The problem is: _____

List any error messages: _____

The following steps reproduce the problem: _____

Documentation Comment Form

National Instruments encourages you to comment on the documentation supplied with our products. This information helps us provide quality products to meet your needs.

Title: *FieldPoint™ FP-1000 /1001 User Manual*

Edition Date: August 1998

Part Number: 321631B-01

Please comment on the completeness, clarity, and organization of the manual.

If you find errors in the manual, please record the page numbers and describe the errors.

Thank you for your help.

Name _____

Title _____

Company _____

Address _____

Phone (____) _____ Fax (____) _____

Mail to: Technical Publications
National Instruments Corporation
6504 Bridge Point Parkway
Austin, TX 78730-5039

Fax to: Technical Publications
National Instruments Corporation
(512) 794-5678

Glossary

Prefix	Meanings	Value
m-	milli-	10^{-3}
k-	kilo-	10^3
M-	mega-	10^6

% percent

° degrees

0x precedes a hexadecimal number

Ω ohms

b bits

B bytes

bank The combination of one FieldPoint network module and one or more terminal bases and I/O modules.

bps bits per second

C celsius

CISPR International Special Committee On Radio Interference

DSR Data Set Ready

EDS electronic data sheet

EMI electromagnetic interference

ESD electrostatic discharge

Glossary

FIFO	first-in-first-out
ft.	feet
FTP	file transfer protocol
g	grams
HotPnP	Hot Plug and Play
Hz	hertz
IEC	International Electrotechnical Commission
in.	inches
I/O	input/output
LED	Light-emitting diode
OPC	OLE for Process Control
POST	power-on self test
RAM	random-access memory
RTS	Request to Send
V	Volts
VDC	Volts direct current
Vrms	Volts root mean squared

A

- ACCESS LED, 2-17, 3-7, 3-8
- addresses, setting
 - network address, 2-12 to 2-14
 - switches (figure), 2-14
 - unique address for each module (note), 2-13

B

- bandwidth, data, 4-5
- banks. *See* FieldPoint banks.
- baud rate
 - address and baud rate switch location (figure), 2-12
 - baud rate switch settings (table), 2-15
- biasing resistors for RS-485 port, 2-10
- BridgeVIEW server, using with FieldPoint, 4-2, 4-12 to 4-13
- bulletin board support, B-1
- bus, high-speed local, 3-1

C

- cable lengths, 2-8, 2-10
- configuration of FieldPoint software, 4-1, 4-4 to 4-11
- configuration of network module
 - address and baud rate selection, 2-12 to 2-15
 - baud rate settings, 2-15
 - network address settings, 2-13 to 2-14
- configuration, saving for FieldPoint bank, 3-2 to 3-4

connections

- network connections
 - FP-1000, 2-7 to 2-8
 - FP-1001, 2-8 to 2-12
- serial port connections, 2-7 to 2-12
 - isolation of RS-485 interface (note), 2-9 to 2-10
 - RS-232 interface specifications, 2-8
 - RS-485 interface specifications, 2-10
- terminal base connection
 - with DIN rail mounting, 2-3
 - with panel mounting, 2-5 to 2-6
- connector pinouts
 - power connector (figure), 2-16
 - RS-232 ports (figure), 2-8
 - RS-485 ports (figure), 2-10
- customer communication, B-1 to B-2, *xi*

D

DIN rail

- connecting terminal bases on, 2-3
- mounting network module on, 2-1 to 2-2
- rail clip, 2-1, 2-2
- removing network module from, 2-4
- distances, 2-8, 2-10
- documentation
 - conventions used in manual, *x-xi*
 - how to use manual set, *ix*
 - organization of manual, *x*
 - related documentation, *xi*

E

electronic support services, B-1 to B-2
 e-mail support, B-2
 environment specifications, A-2
 error conditions indicated by STATUS LED
 (table), 3-8 to 3-9
 Explorer, FieldPoint, 4-2, 4-4 to 4-12

F

fax and telephone support, B-2
 fax-on-demand support, B-2
 feature set description, 3-1 to 3-9
 high-speed local bus, 3-1
 HotPnP (Hot Plug and Play), 3-4 to 3-7
 LED indicators, 3-7 to 3-9
 network watchdog timer, 3-1 to 3-2
 power-on self test (POST), 3-7
 Programmable Power-Up State,
 3-3 to 3-4
 SnapShot feature, 3-2 to 3-3
 FieldPoint banks
 calculating power for bank, 2-16
 maximum number of banks, 1-2
 network watchdog timer, 3-1 to 3-2
 SnapShot feature, 3-2 to 3-3
 FieldPoint network modules. *See also* feature
 set description.
 overview, 1-1 to 1-2
 specifications, A-1 to A-2
 FieldPoint software, 4-1 to 4-22
 BridgeVIEW server, 4-2, 4-12 to 4-13
 configuring, 4-1, 4-1 to 4-11
 FieldPoint Explorer, 4-2, 4-4 to 4-12
 installing, 4-4
 LabVIEW VIs, 4-2, 4-16 to 4-18
 LabWindows/CVI functions, 4-2 to 4-3,
 4-18 to 4-19
 Lookout driver class, 4-2, 4-13 to 4-16
 OPC server, 4-3, 4-19 to 4-20

Optomux Servers, 4-3, 4-2 to 4-22
 overview, 4-1 to 4-3

FP-1000

configuring, 2-12 to 2-15
 connecting to computer, 2-7 to 2-8
 connection to RS-232 port, 1-2
 power connections, 2-5 to 2-7

FP-1001

configuring, 2-12 to 2-15
 connecting to network, 2-8 to 2-12
 connection to RS-485 port, 1-2
 power connections, 2-5 to 2-7

FTP support, 4-1, B-1**H**

HotPnP (Hot Plug and Play), 3-4 to 3-7
 inserting new I/O modules, 3-5
 module configuration results after
 HotPnP replacement (table), 3-6
 during operation, 3-5 to 3-7
 overview, 3-4 to 3-5
 during power-up, 3-5
 replacing I/O modules, 3-5 to 3-7

I

installation, 2-1 to 2-17.
 connecting to computer
 FP-1000, 2-7 to 2-8
 FP-1001, 2-8 to 2-12
 mounting on DIN rail, 2-1 to 2-4
 mounting to panel, 2-4 to 2-6
 HotPnP (Hot Plug and Play) features,
 3-4 to 3-6
 network module installation, 2-1 to 2-2
 power connections, 2-15 to 2-16
 removing network module
 from DIN rail, 2-4
 from panel, 2-6

- serial port connections, 2-7 to 2-129
 - isolation of RS-485 interface (note), 2-9 to 2-10
 - RS-232 interface specifications, 2-8
 - RS-485 interface specifications, 2-10
- terminal base connection
 - with DIN rail mounting, 2-3
 - with panel mounting, 2-5 to 2-6
- I/O modules
 - inserting new, 3-5
 - installing onto terminal bases, 2-6 to 2-7
 - module configuration results after HotPnP replacement (table), 3-6
 - replacing, 3-5 to 3-7
 - saving power-up configuration, 3-2 to 3-4
- Isolation, 2-9 to 2-10

L

- LabVIEW VIs, FieldPoint, 4-2, 4-16 to 4-18
- LabWindows/CVI functions, FieldPoint, 4-2 to 4-3, 4-18 to 4-19
- LED indicators, 3-7 to 3-9
- local bus, high-speed, 3-1
- Lookout driver class, FieldPoint, 4-2, 4-13 to 4-16

M

- manual. *See* documentation.
- mounting. *See* installation.

N

- network address, setting, 2-2 to 2-4
- NETWORK LED, 3-7, 3-8
- network module. *See* FieldPoint network modules.
- network termination and biasing, RS-485 ports, 2-10 to 2-12
- network watchdog timer, 3-1 to 3-2

O

- OPC server, FieldPoint, 4-3, 4-19 to 4-20
- Optomux protocol, 1-2
- Optomux servers, using with FieldPoint, 4-3, 4-21 to 4-22

P

- panel mounting
 - connecting terminal bases on, 2-5 to 2-6
 - mounting network module on, 2-4 to 2-5
 - removing network module and terminal bases from, 2-6
- pinouts. *See* connector pinouts.
- power connections, 2-15 to 2-16
 - calculating power for FieldPoint bank, 2-16
 - pinout (figure), 2-16
- POWER LED, 2-17, 3-7, 3-8
- power-on self test (POST), 3-7
- Programmable Power-Up State, 3-3 to 3-4

R

- rail clip, locking (figure), 2-1
- removing FieldPoint network module
 - from DIN rail, 2-4
 - from panel, 2-6
- removing terminal bases from panel, 2-6
- RS-232 ports
 - connector pinout (figure), 2-8
 - FP-1000 connection to, 1-2, 2-7 to 2-8
 - interface specifications, 2-8
- RS-485 ports
 - connector pinout (figure), 2-10
 - FP-1001 connection to, 1-2, 2-8 to 2-10
 - interface specifications, 2-10
 - isolation from FieldPoint system (note), 2-9 to 2-10

- network termination and biasing,
2-10 to 2-12
- typical signal connections (figures),
2-11 to 2-12

S

- safety isolation, 2-9 to 2-10
- serial ports. See RS-232 ports; RS-485 ports.
- SnapShot feature, 3-2 to 3-3
- software. *See* FieldPoint software.
- specifications, A-1 to A-2
 - compliance, A-2
 - environment, A-2
 - network, A-1 to A-2
- STATUS LED, 2-17, 3-8
- switches
 - address and baud rate switch
(figure), 2-12
 - baud rate switch settings (table), 2-15
 - network address switch settings
(table), 2-14

T

- technical support, B-1 to B-2
- telephone and fax support, B-2
- terminal base connection
 - with DIN rail mounting, 2-3
 - with panel mounting, 2-5 to 2-6
- termination and biasing, RS-485 ports,
2-10 to 2-12
- throughput, 4-3

U

- update rate. *See* throughput.

W

- watchdog timer, 3-1 to 3-2