

COMPREHENSIVE SERVICES

We offer competitive repair and calibration services, as well as easily accessible documentation and free downloadable resources.

SELL YOUR SURPLUS

We buy new, used, decommissioned, and surplus parts from every NI series. We work out the best solution to suit your individual needs.

 Sell For Cash  Get Credit  Receive a Trade-In Deal

OBSOLETE NI HARDWARE IN STOCK & READY TO SHIP

We stock **New, New Surplus, Refurbished, and Reconditioned** NI Hardware.



Bridging the gap between the manufacturer and your legacy test system.

 1-800-915-6216

 www.apexwaves.com

 sales@apexwaves.com

All trademarks, brands, and brand names are the property of their respective owners.

Request a Quote

 **CLICK HERE**

BNC-2120

INSTALLATION GUIDE

BNC-2120

Connector Accessory for E/M/S/X Series Devices

This installation guide describes how to install, configure, and use your BNC-2120 accessory with 68-pin or 100-pin E/M/S/X Series multifunction data acquisition (DAQ) devices. This document also contains accessory specifications.

The BNC-2120 has the following features:

- Eight BNC connectors for analog input (AI) connection
- Onboard temperature reference
- Thermocouple connector
- Resistor measurement screw terminals
- Two BNC connectors for analog output (AO) connection
- Screw terminals for digital I/O (DIO) connection with state indicators
- Screw terminals for timing I/O (TIO) connection
- Two user-defined BNC connectors
- A function generator with the following outputs:
 - Frequency-adjustable, TTL-compatible square wave
 - Frequency- and amplitude-adjustable sine wave or triangle wave
- Quadrature encoder
- A 68-pin I/O connector that connects to multifunction DAQ devices
- Can be used on a desktop or mounted on a DIN rail

Contents

What You Need to Get Started	2
Installing the BNC-2120.....	2
Connecting Analog Input Signals.....	5
Connecting Differential Analog Input Signals	6
Measuring Floating Signals.....	6
Measuring Ground-Referenced Signals.....	7
Measuring Temperature.....	7
Measuring Resistance.....	8
Connecting Analog Output Signals.....	8
Using the Function Generator.....	9
Connecting Timing I/O Signals.....	9
Using the Quadrature Encoder	12
Connecting User-Defined Signals	13
Connecting Digital I/O Signals.....	14
Specifications.....	14

What You Need to Get Started

To set up and use your BNC-2120 accessory, you need the following:

- BNC-2120 accessory/accessories¹
- BNC-2120 Installation Guide*
- One of the following DAQ devices:
 - 68-pin E/M/S/X Series device (with one or two I/O connectors)²
 - 100-pin E Series device
- Cable(s) for DAQ device(s), as listed in Table 1
- The *E Series User Manual*, the *M Series User Manual*, the *S Series User Manual*, or the *X Series User Manual*
- BNC cables
- 28–16 AWG wire
- Wire strippers
- Flathead screwdriver

Installing the BNC-2120



Caution When this symbol is marked on a product, refer to the *Read Me First: Safety and Radio-Frequency Interference* document for information about precautions to take.

Figure 1 shows the front panel of the BNC-2120.

¹ You can use two BNC-2120 accessories with both connectors of two connector M/X Series devices.

² You cannot use the BNC-2120 with Connector 1 of NI 6225/6255 devices.

Figure 1. BNC-2120 Front Panel

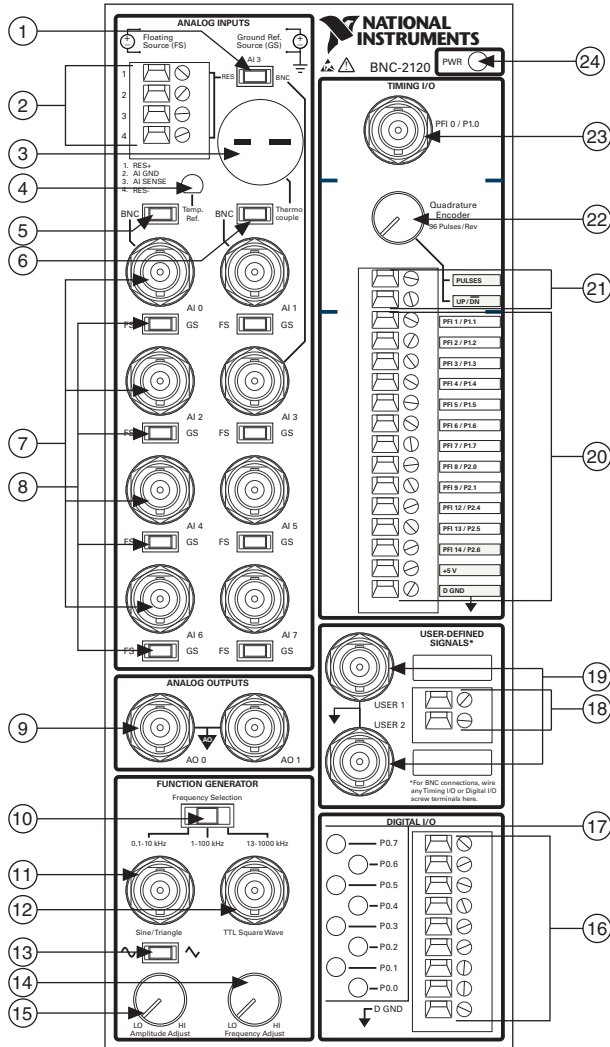

- | | | |
|--|-------------------------------------|---------------------------------------|
| 1 RES/BNC Switch (AI 3) | 9 Analog Output BNC Connector | 17 Digital I/O LEDs |
| 2 Resistor Measurement Screw Terminals | 10 Frequency Range Selection Switch | 18 User-Defined Screw Terminals |
| 3 Thermocouple Input Connector | 11 Sine/Triangle BNC Connector | 19 User-Defined BNC Connectors |
| 4 Temperature Reference | 12 TTL Square Wave BNC Connector | 20 Timing I/O Screw Terminals |
| 5 BNC/Temp. Ref. Switch (AI 0) | 13 Sine/Triangle Waveform Switch | 21 Quadrature Encoder Screw Terminals |
| 6 BNC/Thermocouple Switch (AI 1) | 14 Frequency Adjust Knob | 22 Quadrature Encoder Knob |
| 7 Analog Input BNC Connectors | 15 Amplitude Adjust Knob | 23 Timing I/O BNC Connector |
| 8 FS/GS Switches | 16 Digital I/O Screw Terminals | 24 Power Indicator LED |

To connect the BNC-2120 to your DAQ device, complete the following steps. Consult your computer or PXI/PXI Express chassis user manual for specific instructions and warnings.



Note If you have not already installed your DAQ device, refer to the *DAQ Getting Started* guides for instructions.



Caution Do *not* connect the BNC-2120 to any device other than National Instruments E/M/S/X Series multifunction DAQ devices. Doing so can damage the BNC-2120, the DAQ device, or the host computer. National Instruments is *not* liable for damage resulting from these connections.

- Place the BNC-2120 near the host computer or PXI/PXI Express chassis or use the optional DIN Rail Mounting kit for UMI-FLEX-6 and BNC boxes (Part Number 777972-01), which you can order from National Instruments at ni.com.



Caution Do *not* connect input voltages greater than $42.4 V_{pk}/60$ VDC to the BNC-2120. The BNC-2120 is not designed for any input voltages greater than $42.4 V_{pk}/60$ VDC, even if a user-installed voltage divider reduces the voltage to within the input range of the DAQ device. Input voltages greater than $42.4 V_{pk}/60$ VDC can damage the BNC-2120, all devices connected to it, and the host computer. Overvoltage can also cause an electric shock hazard for the operator. National Instruments is *not* liable for damage or injury resulting from such misuse.

- Connect the BNC-2120 to the DAQ device using the appropriate cable for your DAQ device, as listed in Table 1.



Caution To ensure the specified EMC performance, operate this product only with shielded cables and accessories.

Table 1. BNC-2120 Cabling Options

Number of Pins	DAQ Device	Shielded Recommended Cable	Unshielded Cable
68-pin	DAQCard E Series, NI PCI/PCIe/PXI/PXIe M Series* NI 6143 S Series, PCIe/PXIe/USB X Series	SHC68-68-EPM	RC68-68
	PCI/PXI E Series, USB Mass Termination M Series*, NI 611x/612x/613x S Series†	SH68-68-EPM	R6868†
100-pin	PCI/PXI E Series	SH1006868	—

Caution: For compliance with Electromagnetic Compatibility (EMC) requirements, this product must be operated with shielded cables and accessories. If unshielded cables or accessories are used, the EMC specifications are no longer guaranteed unless all unshielded cables and/or accessories are installed in a shielded enclosure with properly designed and shielded input/output ports.

* You cannot connect the BNC-2120 to Connector 1 of NI 6225/6255 devices.

† Do *not* use the R6868 cable with NI 6115/6120 S Series devices; use *only* the SH68-68-EPM cable.

The power indicator LED, shown in Figure 1, lights. If it does not light, check the cable connections.

3. Launch Measurement & Automation Explorer (MAX), confirm that your DAQ device is recognized, and configure your device settings. Refer to the *DAQ Getting Started* guides for more information.
4. Connect signals to the BNC connectors and screw terminal block as described in the following sections.



Caution To ensure the specified EMC performance, operate this product only with shielded cables and accessories. When connecting signals to the screw terminal blocks, the wires must be shielded (e.g. one conductor of a shielded, multi-conductor cable). The cable shield must be terminated to the D GND or AI GND terminal of the terminal block using as short a connection as is practical.



Note With NI-DAQmx, National Instruments has revised its terminal names so they are easier to understand and more consistent among NI hardware and software products. The revised terminal names used in this document are usually similar to the names they replace. For a complete list of Traditional NI-DAQ (Legacy) terminal names and their NI-DAQmx equivalents, refer to the *Terminal Name Equivalents* table in the *NI-DAQmx Help*.

5. Test specific device functionality, such as the ability to send and receive data with MAX test panels. Refer to the *DAQ Getting Started* guides for detailed information about running test panels in MAX.

When you have finished using the BNC-2120, power off any external signals connected to the BNC-2120 before you power off your computer.

Connecting Analog Input Signals

You can use the analog input BNCs on the BNC-2120 in the following ways:

- Measure differential AI signals, as described in the [Connecting Differential Analog Input Signals](#) section
- Measure temperature, as described in the [Measuring Temperature](#) section
- Measure resistance, as described in the [Measuring Resistance](#) section

Connecting Differential Analog Input Signals

Use the BNC-2120 BNC connectors on the front panel to connect AI <0..7> signals to your DAQ device. The BNC-2120 is *only* intended for differential analog input signals. The number of connectors you use depends on your DAQ device and application. Complete the following steps to measure a differential (DIFF) analog input signal.

1. Connect the BNC cable to one of the AI <0..7> BNC connectors on the front panel.¹
2. If you are using AI 0, move the BNC/Temp. Ref. switch to the BNC position.
If you are using AI 1, move the BNC/Thermocouple switch to the BNC position.
If you are using AI 3, move the RES/BNC switch to the BNC position.
3. Configure your software to measure the channel differentially.
4. Move the FS/GS switch to the applicable position, depending on whether you are measuring a floating source (FS) or ground-referenced source (GS) analog input signal. Refer to the *Measuring Floating Signals* and *Measuring Ground-Referenced Signals* sections for more information about these signal sources.

Measuring Floating Signals

To measure floating signal sources, move the corresponding switch below the BNC connector to the FS position. In the floating source switch position, the DAQ device's amplifier negative terminal connects to ground through a 4.99 k Ω resistor, as shown in Figure 2. Refer to your DAQ device documentation for more information about measuring floating signals.

Figure 2. Measuring a Floating Signal Source

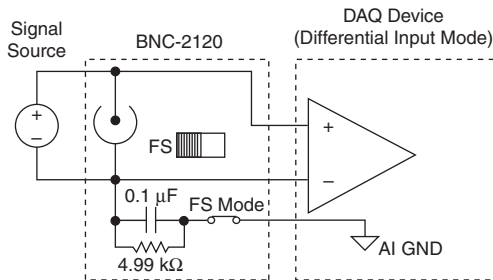

¹ When using the BNC-2120 with Connector 1 of two connector M/X Series devices, the AI <0..7> BNCs on the BNC-2120 map to the AI <16..23> channels on the device.

Measuring Ground-Referenced Signals

To measure ground-referenced signals, move the switch below the BNC connector for the AI channel you are using to the GS position. Using the ground-referenced source switch position avoids ground loops, as shown in Figure 3. Refer to your DAQ device documentation for more information about measuring ground-referenced signals.

Figure 3. Measuring a Ground-Referenced Signal Source

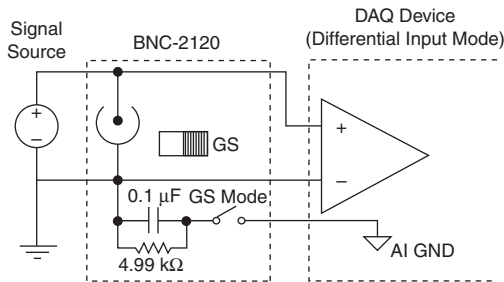

AI GND and AI SENSE signals are located at the analog input screw terminals of the BNC-2120. When connecting signals to the screw terminals, use 28–16 AWG wire with the insulation stripped to 0.28 in.

Measuring Temperature

You can measure temperature on the BNC-2120 with the temperature reference and thermocouple connector.

To use the integrated circuit (IC) temperature reference on the BNC-2120, move the BNC/Temp. Ref. switch above the AI 0 BNC to Temp. Ref. The integrated circuit (IC) temperature reference provides built-in cold-junction compensation (CJC) through software. The IC sensor voltage is linearly proportional to the sensor temperature where:

$$^{\circ}\text{C} = \text{Volts} \times 100$$

The sensor is accurate to $\pm 1.5^{\circ}\text{C}$.

To use the thermocouple on the BNC-2120, move the BNC/Thermocouple switch above the AI 1 BNC to Thermocouple. You can connect any type of thermocouple with a two-prong miniature or subminiature male connector to the thermocouple connector.

For more information on thermocouples and CJC, refer to the Developer Zone document, *Taking Thermocouple Temperature Measurements*, by going to ni.com/info and entering the Info Code `rdtttm`.

Measuring Resistance

You can measure resistance with the analog input screw terminals on the BNC-2120. Figure 4 is a schematic representation of how the BNC-2120 measures resistance.

Figure 4. Measuring Resistance on the BNC-2120

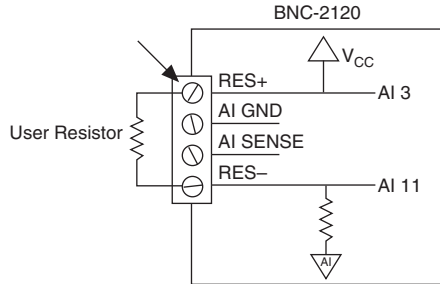

RES+ is internally connected to AI 3 and V_{CC}. RES- is internally connected to AI 11. There is also a 10 kΩ resistor between AI 11 and AI GND.

When connecting signals to the screw terminals, use 28–16 AWG wire with the insulation stripped to 0.28 in.

Complete the following steps to measure resistance.

1. Move the RES/BNC switch above the AI 3 BNC to the RES position.
2. Configure your software to measure AI 3 and AI 11 in referenced single-ended (RSE) mode.
3. Connect the resistor to the RES+ and RES- screw terminals.
You can measure resistors with values ranging from 100 Ω to 1 MΩ.
4. Measure V_{CC} on AI 3 and the voltage drop across the internal 10 kΩ resistor on AI 11.
5. With these measurements, calculate the resistor value using the following formula:

$$\text{Resistor Value} = \frac{V_{\text{AI } 3} - V_{\text{AI } 11}}{V_{\text{AI } 11} / (10 \text{ k}\Omega)}$$

Connecting Analog Output Signals

Use the AO <0..1> BNC connectors on the BNC-2120 front panel to connect analog output signals to your DAQ device.¹ The number of connectors you use depends on your DAQ device and application. Refer to your DAQ device documentation for information about the use of these signals.

¹ When using the BNC-2120 with Connector 1 of two connector M/X Series devices, the AO <0..1> BNCs on the BNC-2120 map to the AO <2..3> channels on the device.

Using the Function Generator

The BNC-2120 has a function generator that produces sine or triangle waveforms and TTL-compatible square waveforms. Use the switch below the Sine/Triangle BNC to select a sine wave or triangle wave output for the connector. A TTL-compatible square wave is always present at the TTL Square Wave BNC.

To adjust the frequency of the function generator, select your frequency range using the Frequency Selection switch. You can select 0.1–10 kHz, 1–100 kHz, or 13–1000 kHz. The Frequency Adjust knob adjusts the frequency within the preselected range for the sine or triangle wave and the TTL square wave outputs.

The Amplitude Adjust knob adjusts the amplitude of the sine or triangle wave output up to $4.4 V_{p-p}$.

Connecting Timing I/O Signals

Connect the timing I/O signals of your DAQ device to the PFI 0/P1.0 (AI START TRIG) BNC or the timing I/O screw terminals on the BNC-2120. When connecting signals to the screw terminals, use 28–16 AWG wire with the insulation stripped to 0.28 in.

Table 2 describes the timing I/O BNC and terminal signals on the BNC-2120.

Table 2. BNC-2120 Timing I/O BNC/Terminal Descriptions

BNC/Terminal	Description
PFI 0/P1.0	Programmable Function Interface channel 0 or Port 1 Digital Input/Output channel 0
	AI START TRIG (AI Start Trigger Signal)—As an output, this pin is the ai/StartTrigger signal. In post-trigger DAQ sequences, a low-to-high transition indicates the initiation of the acquisition sequence. In applications with pre-trigger samples, a low-to-high transition indicates the initiation of the pre-trigger samples.
PULSES	Refer to the Using the Quadrature Encoder section for information about using these terminals.
UP/ \overline{DN}	
PFI 1/P1.1	Programmable Function Interface channel 1 or Port 1 Digital Input/Output channel 1
	AI REF TRIG (AI Reference Trigger Signal)—As an output, this pin is the ai/ReferenceTrigger signal. In applications with pretrigger samples, a low-to-high transition indicates the initiation of the post-trigger samples. AI Reference Trigger is not used in applications with posttrigger samples.

Table 2. BNC-2120 Timing I/O BNC/Terminal Descriptions (Continued)

BNC/Terminal	Description
PFI 2/P1.2	Programmable Function Interface channel 2 or Port 1 Digital Input/Output channel 2
	AI CONV CLK (AI Convert Clock Signal)—As an output, this pin is the ai/ConvertClock signal. A high-to-low edge on AI CONV indicates that an A/D conversion is occurring.
PFI 3/P1.3	Programmable Function Interface channel 3 or Port 1 Digital Input/Output channel 3
	CTR 1 SOURCE (Counter 1 Source Signal)—As an output, this pin is the Ctr1Source signal. This signal reflects the actual source connected to the general-purpose counter 1.
PFI 4/P1.4	Programmable Function Interface channel 4 or Port 1 Digital Input/Output channel 4
	CTR 1 GATE (Counter 1 Gate Signal)—As an output, this pin is the Ctr1Gate signal. This signal reflects the actual gate signal connected to the general-purpose counter 1.
PFI 5/P1.5	Programmable Function Interface channel 5 or Port 1 Digital Input/Output channel 5
	AO SAMP CLK (AO Sample Clock Signal)—As an output, this pin is the ao/SampleClock signal. A high-to-low edge on AO SAMP indicates that the AO primary group is being updated.
PFI 6/P1.6	Programmable Function Interface channel 6 or Port 1 Digital Input/Output channel 6
	AO START TRIG (AO Start Trigger Signal)—As an output, this pin is the ao/StartTrigger signal. In timed AO sequences, a low-to-high transition indicates the initiation of the waveform generation.
PFI 7/P1.7	Programmable Function Interface channel 7 or Port 1 Digital Input/Output channel 7
	AI SAMP CLK (AI Sample Clock Signal)—As an output, this pin is the ai/SampleClock signal. This pin pulses once at the start of each AI sample in the interval sample. A low-to-high transition indicates the start of the sample.

Table 2. BNC-2120 Timing I/O BNC/Terminal Descriptions (Continued)

BNC/Terminal	Description
PFI 8/P2.0	Programmable Function Interface channel 8 or Port 2 Digital Input/Output channel 0
	CTR 0 SOURCE (Counter 0 Source Signal)—As an output, this pin is the Ctr0Source signal. This signal reflects the actual source connected to the general-purpose counter 0.
PFI 9/P2.1	Programmable Function Interface channel 9 or Port 2 Digital Input/Output channel 1
	CTR 0 GATE (Counter 0 Gate Signal)—As an output, this pin is the Ctr0Gate signal. This signal reflects the actual gate signal connected to the general-purpose counter 0.
PFI 12/P2.4	Programmable Function Interface channel 12 or Port 2 Digital Input/Output channel 4
	CTR 0 OUT (Counter 0 Output Signal)—As an input, this pin can be used to route signals directly to the RTSI bus. As an output, this pin emits the Ctr0InternalOutput signal.
PFI 13/P2.5	Programmable Function Interface channel 13 or Port 2 Digital Input/Output channel 5
	CTR 1 OUT (Counter 1 Output Signal)—As an input, this pin can be used to route signals directly to the RTSI bus. As an output, this pin emits the Ctr1InternalOutput signal.
PFI 14/P2.6	Programmable Function Interface channel 14 or Port 2 Digital Input/Output channel 6
	FREQ OUT (Frequency Output)—This output is from the frequency generator.
+5 V	+5 V Power—These terminals are fused on the DAQ device and are self-resetting. The current available depends on the product to which it is connected.
D GND	Digital Ground—This terminal supplies the reference for the digital signals at the I/O connector as well as the +5 VDC supply.

Using the Quadrature Encoder

The BNC-2120 contains a mechanical quadrature encoder circuit that produces 96 pulses per encoder revolution. Two outputs, PULSES and UP/ $\overline{\text{DN}}$, are at the screw terminals located below the quadrature encoder knob.

PULSES outputs a pulse train generated by rotating the encoder shaft. It provides four pulses per one mechanical click of the encoder. UP/ $\overline{\text{DN}}$ outputs a high or a low signal indicating rotation direction. When the direction is counterclockwise, UP/ $\overline{\text{DN}}$ is low. When the direction is clockwise, UP/ $\overline{\text{DN}}$ is high.

To use the quadrature encoder with counter 0 of the DAQ device, connect the PULSES terminal to PFI 8 and connect the UP/ $\overline{\text{DN}}$ terminal to the P0.6 digital I/O terminal, the up/down pin of counter 0. To use the quadrature encoder with counter 1, connect the PULSES terminal to PFI 3 and connect the UP/ $\overline{\text{DN}}$ terminal to the P0.7 digital I/O terminal, the up/down pin of counter 1. Refer to Table 2 for more information about PFI 3 and PFI 8. Refer to the [Connecting Digital I/O Signals](#) section for more information about the digital I/O terminals and LEDs.

You can use the Count Digital Events VI from the LabVIEW Example Finder (**Hardware Input and Output»DAQmx»Counter Measurements»Count Digital Events**) with the BNC-2120 quadrature encoder. After opening the VI, select **Externally Controlled** in the Count Direction control. The VI retrieves the count from the counter. You can convert the count into total degrees rotated using the following formula:

$$\text{Total Degrees Rotated} = \text{PULSES} \times 3.75^\circ/\text{pulse}$$

where

$$3.75^\circ/\text{pulse} = 360^\circ/96 \text{ pulses}$$

Calculate the number of revolutions and remaining degrees by dividing the total degrees rotated by 360° . The calculated quotient is equal to the number of revolutions and the remainder is equal to the remaining degrees.

Connecting User-Defined Signals

The USER 1 and USER 2 BNC connectors allow you to use a BNC connector for a digital I/O or timing I/O signal of your choice. The USER 1 and USER 2 BNC connectors are routed (internal to the BNC-2120) to the USER 1 and USER 2 screw terminals, as shown in Figure 5.

Figure 5. USER <1..2> BNC Connections

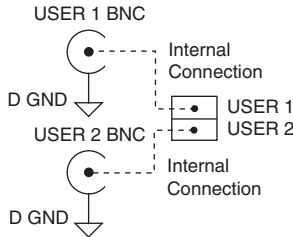
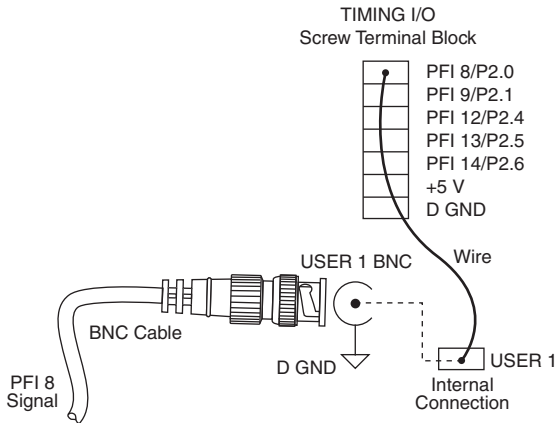

Figure 6 shows an example of how to use the USER 1 and USER 2 BNCs. To access the PFI 8/P2.0 (CTR 0 SOURCE) signal from a BNC, connect USER 1 on the screw terminal block to PFI 8/P2.0 with a 28–16 AWG wire.

Figure 6. Connecting PFI 8 to USER 1 BNC



The designated space next to each USER <1..2> BNC is for marking or labeling signal names.

Connecting Digital I/O Signals

Connect to the digital I/O signals of your DAQ device to the digital I/O screw terminals, P0.<0..7>, on the BNC-2120. You can individually configure each signal as an input or output. D GND is available at the screw terminals to supply the reference for the DIO signals. When connecting signals to the screw terminals, use 28–16 AWG wire with the insulation stripped to 0.28 in.



Note P0.6 and P0.7 can control the up/down signal of general-purpose counters 0 and 1, respectively. Refer to the [Using the Quadrature Encoder](#) section for more information about using the P0.6 and P0.7 terminals with the quadrature encoder.

The LEDs next to each screw terminal indicate the state of each digital line, as listed in Table 3.

Table 3. Digital I/O LEDs

Digital I/O LED	Digital Port State
Lit	The port is either pulled high or driven high
Not lit	The port is either pulled low or driven low

Specifications

This section lists the specifications of the BNC-2120. These specifications are typical at 25 °C unless otherwise specified.



Note Refer to your DAQ device documentation for specifications about analog input, analog output, trigger/counter, and digital and timing I/O signals.

Analog Input

- Number of channels (default) 8 differential
- Field connections (default) 8 BNC connectors
- Protection No additional protection provided.
Consult your DAQ device specifications.
- Optional inputs
 - AI 0 Temperature sensor
 - AI 1 Thermocouple
 - AI 3, AI 11 Resistor measurement (requires RSE configuration)
- Optional connections
 - Thermocouple Uncompensated miniature connector, mates with 2-prong miniature or subminiature connector
 - Resistor 2 screw terminals

Resistor measurement range.....	100 Ω to 1 M Ω
Resistor measurement error	$\leq 5\%$
Screw terminals	4 positions, 28–16 AWG wire
Switches	
Floating source/grounded source	8
BNC/temperature reference IC	1
BNC/thermocouple connector	1
BNC/resistor screw terminals	1

Analog Output

Field connection	2 BNC connectors
------------------------	------------------

Digital Input/Output

Screw terminals	9 positions, 28–16 AWG wire
-----------------------	-----------------------------

LED state indicators	8, 1 each for lines P0.<0..7>
----------------------------	-------------------------------

Protection (DC max V)

Powered off.....	± 5.5 V
Powered on	+10/–5 V

Drive

V _{ol}	0.6 V, 8 mA
	1.6 V, 24 mA
V _{oh}	4.4 V, 8 mA
	4 V, 13 mA

Function Generator

Square wave.....	TTL-compatible
Frequency range	100 Hz to 1 MHz
Frequency adjust.....	Through the Frequency Adjust knob
Rise time	2 ns
Fall time	2 ns

Sine/triangle wave

Frequency range	100 Hz to 1 MHz
Frequency adjust.....	Through the Frequency Adjust knob
Amplitude range	200 mV _{p-p} to 4.8 V _{p-p}
Amplitude adjust.....	Through the Amplitude Adjust knob
Output impedance.....	453 Ω (sine/triangle wave)
	50 Ω (square wave)

Figure 7. Typical Maximum Voltages versus Load Impedances

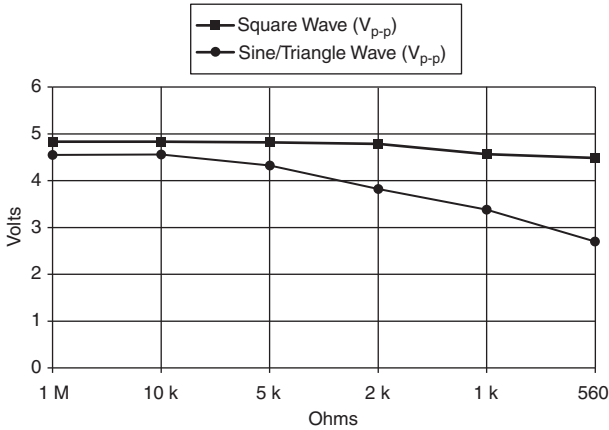

Timing Input/Output

- Screw terminals..... 14 positions, 28–16 AWG wire
- BNC connector 1, for PFI 0/AI START TRIG
- Protection (DC max V)
 - Powered off..... ± 1.7 V
 - Powered on +6.7/–1.7 V

Quadrature Encoder

- Screw terminals..... 2
- Output signals
 - PULSES 96 pulses/revolution
 - UP/ $\overline{\text{DN}}$ High for clockwise rotation,
low for counterclockwise rotation
- Pulse width..... 1 μ s

Power Requirement

- +5 VDC ($\pm 5\%$)..... 200 mA, sourced from the multifunction DAQ device
- Power available at +5 V screw terminal Multifunction DAQ device power,
less power consumed at +5 VDC ($\pm 5\%$)

Physical

- Dimensions 26.7 cm \times 11.2 cm \times 5.97 cm
(10.5 in. \times 4.41 in. \times 2.35 in.)
- Weight 1,040 g (2 lb 4.7 oz)

I/O connector	68-pin male SCSI-II type
BNC connectors.....	15
Screw terminal plugs	31

Environment

Operating temperature	0 to 50 °C
Storage temperature	-55 to 125 °C
Relative humidity	5 to 90%, noncondensing
Pollution Degree	2
Maximum altitude.....	2,000 m
Indoor use only	

Safety

This product is designed to meet the requirements of the following standards of safety for electrical equipment for measurement, control, and laboratory use:

- IEC 61010-1, EN 61010-1
- UL 61010-1, CSA 61010-1



Note For UL and other safety certifications, refer to the product label or the [Online Product Certification](#) section.



Caution The protection provided by the BNC-2120 can be impaired if it is used in a manner not described in this document.

Electromagnetic Compatibility

This product meets the requirements of the following EMC standards for electrical equipment for measurement, control, and laboratory use:

- EN 61326-1 (IEC 61326-1): Class A emissions; Basic immunity
- EN 55011 (CISPR 11): Group 1, Class A emissions
- AS/NZS CISPR 11: Group 1, Class A emissions
- FCC 47 CFR Part 15B: Class A emissions
- ICES-001: Class A emissions



Note In the United States (per FCC 47 CFR), Class A equipment is intended for use in commercial, light-industrial, and heavy-industrial locations. In Europe, Canada, Australia and New Zealand (per CISPR 11) Class A equipment is intended for use only in heavy-industrial locations.



Note Group 1 equipment (per CISPR 11) is any industrial, scientific, or medical equipment that does not intentionally generate radio frequency energy for the treatment of material or inspection/analysis purposes.



Note For EMC declarations and certifications, and additional information, refer to the *Online Product Certification* section.

CE Compliance

This product meets the essential requirements of applicable European Directives as follows:

- 2006/95/EC; Low-Voltage Directive (safety)
- 2004/108/EC; Electromagnetic Compatibility Directive (EMC)

Online Product Certification

To obtain product certifications and the Declaration of Conformity (DoC) for this product, visit ni.com/certification, search by model number or product line, and click the appropriate link in the Certification column.

Environmental Management

NI is committed to designing and manufacturing products in an environmentally responsible manner. NI recognizes that eliminating certain hazardous substances from our products is beneficial to the environment and to NI customers.

For additional environmental information, refer to the *Minimize Our Environmental Impact* web page at ni.com/environment. This page contains the environmental regulations and directives with which NI complies, as well as other environmental information not included in this document.

Waste Electrical and Electronic Equipment (WEEE)



EU Customers At the end of the product life cycle, all products *must* be sent to a WEEE recycling center. For more information about WEEE recycling centers, National Instruments WEEE initiatives, and compliance with WEEE Directive 2002/96/EC on Waste and Electronic Equipment, visit ni.com/environment/weee.

电子信息产品污染控制管理办法（中国 RoHS）



中国客户 National Instruments 符合中国电子信息产品中限制使用某些有害物质指令 (RoHS)。关于 National Instruments 中国 RoHS 合规性信息，请登录 ni.com/environment/rohs_china。(For information about China RoHS compliance, go to ni.com/environment/rohs_china.)

LabVIEW, National Instruments, NI, ni.com, the National Instruments corporate logo, and the Eagle logo are trademarks of National Instruments Corporation. Refer to the *Trademark Information* at ni.com/trademarks for other National Instruments trademarks. Other product and company names mentioned herein are trademarks or trade names of their respective companies. For patents covering National Instruments products/technology, refer to the appropriate location: **Help»Patents** in your software, the `patents.txt` file on your media, or the *National Instruments Patents Notice* at ni.com/patents. Refer to the *Export Compliance Information* at ni.com/legal/export-compliance for the National Instruments global trade compliance policy and how to obtain relevant HTS codes, ECCNs, and other import/export data.

© 1999–2012 National Instruments. All rights reserved.