

## COMPREHENSIVE SERVICES

We offer competitive repair and calibration services, as well as easily accessible documentation and free downloadable resources.

## SELL YOUR SURPLUS

We buy new, used, decommissioned, and surplus parts from every NI series. We work out the best solution to suit your individual needs.

 Sell For Cash    Get Credit    Receive a Trade-In Deal

## OBSOLETE NI HARDWARE IN STOCK & READY TO SHIP

We stock **New**, **New Surplus**, **Refurbished**, and **Reconditioned** NI Hardware.



*Bridging the gap between the manufacturer and your legacy test system.*

 1-800-915-6216

 [www.apexwaves.com](http://www.apexwaves.com)

 [sales@apexwaves.com](mailto:sales@apexwaves.com)

*All trademarks, brands, and brand names are the property of their respective owners.*

**Request a Quote**

 **CLICK HERE**

**PXI-1002**

PRODUCT FLYER

# PXI Express Chassis

## CONTENTS

[PXI Express Chassis](#)

[Detailed View of PXIe-1095 Series Chassis](#)

[Key Features](#)

[PXIe Chassis Configuration and Monitoring Software](#)

[System Configuration \(API\)](#)

[Platform-Based Approach to Test and Measurement](#)

[PXI Instrumentation](#)

[Hardware Services](#)

# PXI Express Chassis

PXIe-1095, PXIe-1086, PXIe-1085, PXIe-1084, PXIe-1075, PXIe-1066DC, PXIe-1065, PXIe-1092, PXIe-1088, PXIe-1078, PXIe-1082, PXIe-1082DC, PXIe-1062Q, PXIe-1073, and PXIe-1071



- Breadth of size options from 4 to 18 slots
- Hybrid slots for instrumentation flexibility; compatibility with PXI, PXI Express, CompactPCI, and CompactPCI Express modules
- Performance—up to 24 GB/s system and 8 GB/s per-slot dedicated bandwidth
- Up to 82 W per slot of power and cooling for more advanced I/O modules
- High availability options with redundant power supplies and fans
- Quiet options for the benchtop
- System monitoring features for voltage rails, temperature, and fan speed

## Built for Automated Test and Measurement

As the leader in PXI test and measurement, NI provides a PXI Express chassis portfolio with a wide breadth of size and performance options and with additional features beyond those required in the PXI specification that are designed to simplify system interaction and usability. PXI Express chassis incorporate high-bandwidth backplanes with PCI Express data communication to enable significantly higher system bandwidth than legacy PXI-1 chassis. In addition, each chassis includes a 10 MHz and 100 MHz reference clock and trigger bus, and many also include a timing slot for higher stability and multichassis timing and synchronization capabilities. From offering the quietest chassis on the market for benchtop users to the highest power and cooling capability of any PXI chassis for advanced processing and performance, NI's portfolio breadth provides the flexibility needed to optimize for your test requirements and adapt over time.

Table 1. NI offers PXI Express chassis ranging from four to 18 slots and up to 24GB/s of system bandwidth. **Bolded** chassis reflect NI's recommended options for each size and performance tier.

Chassis	Total Slots	Hybrid Slots	PXIe-Only Slots	PXI-Only Slots	System Bandwidth	Slot Bandwidth	Slot Cooling Capacity <sup>2</sup>	Power Supply Type	Redundant HW
<b>PXIe-1095<sup>5</sup></b>	18	5	11 + 1 ST <sup>1</sup>	0	24 GB/s	8 GB/s	82 W	AC	Yes <sup>4</sup>
PXIe-1086	18	16	1 ST <sup>1</sup>	0	12 GB/s	4 GB/s	38 W	AC	Yes <sup>3</sup>
PXIe-1085 (24 GB/s)	18	16	1 ST <sup>1</sup>	0	24 GB/s	8 GB/s	38 W	AC	No
PXIe-1085	18	16	1 ST <sup>1</sup>	0	12 GB/s	4 GB/s	38 W	AC	No
<b>PXIe-1084<sup>6</sup></b>	18	17	0	0	4 GB/s	500 MB/s	58 W	AC	No
PXIe-1075	18	8	8 + 1 ST <sup>1</sup>	0	4 GB/s	1 GB/s	38 W	AC	No
PXIe-1066DC	18	4	3 + 1 ST <sup>1</sup>	9	3 GB/s	1 GB/s	38 W	DC	Yes <sup>3</sup>
PXIe-1065	18	4	3 + 1 ST <sup>1</sup>	9	3 GB/s	1 GB/s	38 W	AC	No
<b>PXIe-1092<sup>5</sup></b>	10 <sup>7</sup>	7	1 ST <sup>1</sup>	0	24 GB/s	8 GB/s	82 W	AC	No
<b>PXIe-1088</b>	9	8	0	0	8 GB/s	2 GB/s <sup>8</sup>	58 W	AC	No
PXIe-1078	9	5	3	0	1.75 GB/s	250MB/s	38 W	AC	No
PXIe-1082	8	4	2 + 1 ST <sup>1</sup>	0	8 GB/s	2 GB/s	38 W	AC	No
PXIe-1082DC	8	4	2 + 1 ST <sup>1</sup>	0	8 GB/s	2 GB/s	38 W	DC	No
PXIe-1062Q	8	2	1 ST <sup>1</sup>	4	3 GB/s	1 GB/s	38 W	AC	No
<b>PXIe-1073<sup>9</sup></b>	5	3	2	0	250 MB/s	250 MB/s	38 W	AC	No
<b>PXIe-1071</b>	4	3	0	0	3 GB/s	1 GB/s	38 W	AC	No

<sup>1</sup> ST = System Timing

<sup>2</sup> Slot cooling capacity indicates the cooling capacity in each peripheral slot, but power budgeting may still be required for the full system. See the specifications document for more details regarding available system power and operating environment.

<sup>3</sup> Product contains redundant fans and power supplies to enable hot-swappable replacement for high-availability applications

<sup>4</sup> The PXIe-1095 offers two hot-swappable power supplies. The PXIe-1095 shipping kit includes one power supply; the second power supply must be purchased separately, if needed. To dissipate 82 W of power in every slot, both power supplies are required. For applications consisting entirely of modules dissipating up to 38 W each, only one power supply is required – a second power supply is redundant to such applications.

<sup>5</sup> The PXIe-1095 and PXIe-1092 offer an optional timing and synchronization upgrade at time of purchase that includes an integrated oven-controlled crystal oscillator (OCXO) for increased clock accuracy as well as external clock and trigger routing.

<sup>6</sup> The PXIe-1084 offers an optional timing and synchronization upgrade at time of purchase that includes external clock and trigger routing.

<sup>7</sup> The PXIe-1092 includes an additional peripheral expansion slot in Slot 10, which does not have a PXI Express connection but can provide power for multi-slot modules. See the user manual for more details.

<sup>8</sup> The PXIe-1088 supports 2 GB/s dedicated bandwidth in three slots and 500 MB/s in five slots.

<sup>9</sup> The PXIe-1073 includes an integrated MXI-Express controller and does not require an additional PXI controller.

## Power and Cooling Caveats

Some NI chassis can dissipate and cool more than 38 W in a peripheral slot to support new PXI modules that either recommend or require additional power and cooling to achieve full capability. These chassis vary in total power, so system power budgeting is always recommended. For a full list of NI modules that recommend or require more than 38 W, see this [white paper](#).

Chassis	Total Slots	Slot Cooling Capacity	Total Available Power	Total Chassis Power <sup>1</sup>	Operating Environment	
PXIe-1095	18	82 W	1644 W	2400 W <sup>2</sup>	All modules require ≤ 58 W cooling capacity per slot	0 – 55 °C
					Any module requires > 58 W cooling capacity per slot	0 – 40 °C
PXIe-1092	10 <sup>3</sup>	82 W	988 W	1200 W	All modules require ≤ 58 W cooling capacity per slot	0 – 55 °C
					Any module requires > 58 W cooling capacity per slot	0 – 40 °C
PXIe-1084	18	58 W	650 W	800 W	All modules require ≤ 38 W cooling capacity per slot	0 – 50 °C
					Any module requires > 38 W cooling capacity per slot	0 – 40 °C
PXIe-1088	9	58 W	329 W	400 W	All modules require ≤ 38 W cooling capacity per slot	0 – 50 °C
					Any module requires > 38 W cooling capacity per slot	0 – 40 °C

<sup>1</sup> Total chassis power differs from total *available* power to the system controller and peripheral modules, due to typical chassis overhead. See the chassis specifications for more details.

<sup>2</sup> The PXIe-1095 offers two hot-swappable 1200 W power supplies. The PXIe-1095 shipping kit includes one power supply; the second power supply must be purchased separately, if needed. To dissipate 82 W of power in every slot, both power supplies are required. For applications consisting entirely of modules dissipating up to 38 W each, only one power supply is required – a second power supply is redundant to such applications.

<sup>3</sup> The PXIe-1092 includes an additional peripheral expansion slot in Slot 10, which does not have a PXI Express connection but can provide power for multi-slot modules. See the user manual for more details.

# Detailed View of PXIe-1095 Chassis

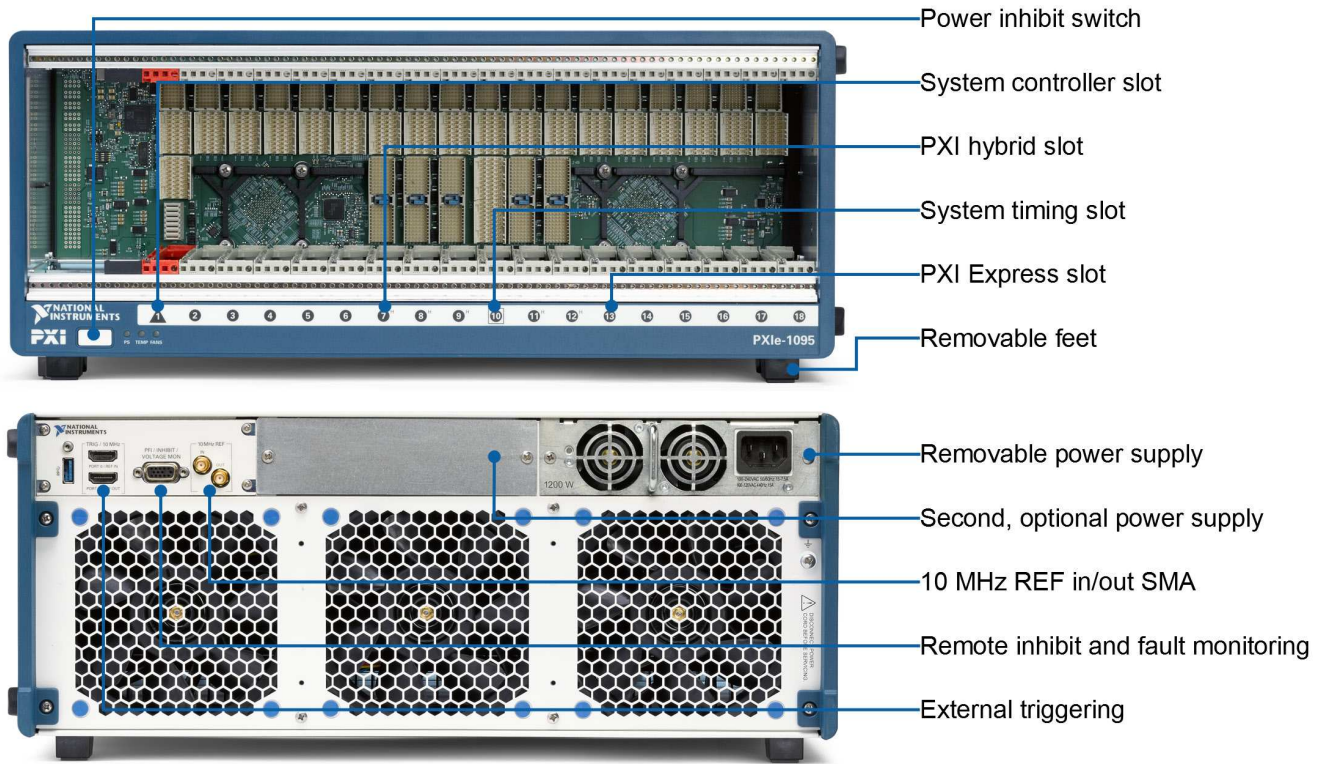



# Key Features

---

## Cooling

NI chassis are designed and validated to meet or exceed the cooling requirements for the most power-demanding PXI modules. The PXI Express power specification requires a minimum of 30 W of power be available to each peripheral slot and that each slot can dissipate that same amount of heat.

PXI Express Chassis designed by NI exceed PXI Express requirements by providing at least 38.25 W of power and cooling to every peripheral slot; some chassis push slot cooling capacity even further and can provide 58 W or 82 W of cooling to a single slot. This extra power and cooling makes advanced capabilities of high-performance modules, such as digitizers, high-speed digital I/O, and RF modules, possible in applications that may require continuous acquisition or high-speed testing. Chassis vary in total system power, so it is always recommended to perform a system-level power budget when configuring a new system.

## All-Hybrid Slot Options

You can insert both PXI Express and hybrid-compatible PXI modules in the PXIe-1084 chassis because all 17 peripheral slots are hybrid slots for maximum instrument placement flexibility. As seen in Table 1, all NI PXI Express chassis feature at least a few hybrid slots, but some are more optimized for this use case than others.

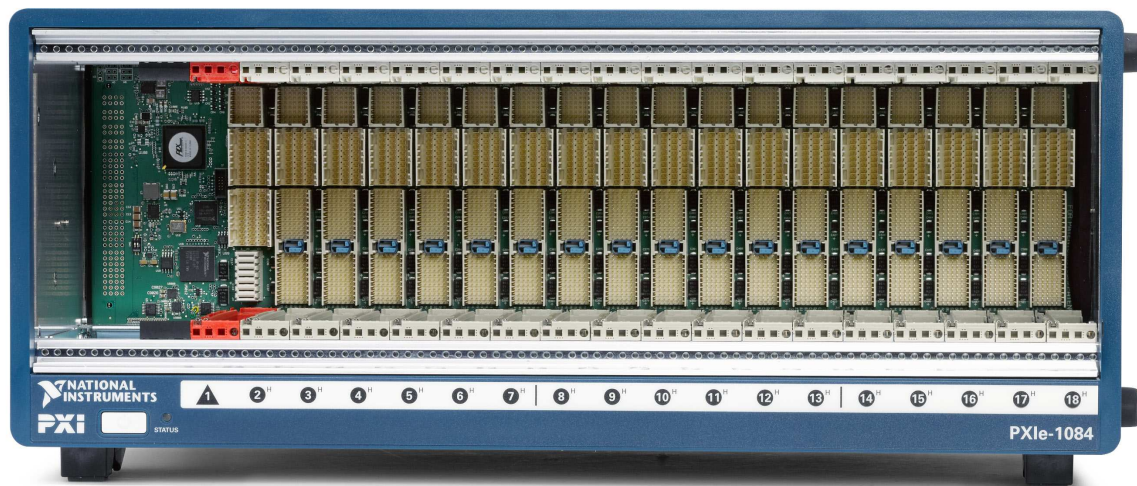

Figure 1. The PXIe-1084 features 17 hybrid peripheral slots.

## Acoustics

Even with their advanced cooling capabilities, NI PXI chassis are designed to minimize the overall system acoustic emissions, which is particularly important for benchtop validation environments. The PXIe-1084, PXIe-1092, and PXIe-1095 are NI's quietest chassis in their typical 38 W cooling profiles, with sound pressure levels in the range of only 34-38 dBA, more than 2x quieter than other vendors' large chassis. Combining fan speed control, the type of fan used, and fan mounting method makes cooling optimization possible while minimizing the acoustic noise emitted.

NI implements pulse-width modulated (PWM) fans in many of its PXI chassis to reduce acoustic emissions further than that of traditional voltage-controlled fans. PWM signal control of the fan permits the NI chassis designer to use a wider range of the fan's RPM settings, thus making it possible to fine tune the chassis' acoustic emissions and cooling performance.

## Power Supplies

NI maintains design ownership of the instrument-grade power supplies in many of its eight to 18-slot chassis. Thus, NI can guarantee long-term availability of these power supplies and fewer design changes to its chassis due to power supply manufacturer changes. In contrast, other PXI vendors who rely solely on a standard PC power supply have little to no control over the quality of their power supplies.

The instrument-grade power supplies implemented within NI PXI chassis are optimized to meet the unique power requirements of PXI as opposed to ATX power supplies, which are designed for general use in personal computers. They are custom-designed for NI chassis to meet and exceed the PXI specification minimum power requirements. With these power supplies, NI PXI Express chassis can deliver at least 38.25 W to a peripheral module. Some chassis push this even further, such as the PXIe-1095 and PXIe-1092, which can deliver 82 W of power to all modules in a filled chassis.

As NI PXI chassis implement instrument-grade power supplies, they can provide the minimum power requirement over the entire specified operating temperature range (0–50/55 °C) with no power derating. To reiterate, with an NI PXI chassis you can operate a chassis filled with modules at the highest temperature specified on the data sheet (please refer to product manuals for operating temperature ranges for specific NI PXI chassis models).

The electrical noise generated by moving mechanical features within the chassis, specifically cooling fans, can degrade the measurement accuracy of PXI and PXI Express peripheral modules. To prevent this, many NI chassis not only place cooling fans in the rear of the chassis, but also implement a dedicated 12 V power supply to power the chassis cooling fans, system controller slot, and in some cases the power supply fans, to avoid coupling noise from these components into the rails powering the measurement modules.

Most NI chassis also feature remote sensing of the output voltage on the backplane power rails, to compensate for voltage drops. This design feature is important for PXI Express chassis particularly for applications with high-power modules, as it provides better regulation at the backplane when there are large load swings.

## Chassis Monitoring – Voltage Rails, Fan Speed, Temperature

NI chassis have several internal sensors for monitoring individual voltage rails, fan speed, and temperature that display their current value in NI MAX or can be programmatically accessed through the System Configuration API to ensure stable operating conditions. These temperature readings for instance give you the ability to understand the operating temperatures of your system and instruments for troubleshooting purposes, and some temperature readings are even used in the fan speed algorithm of the chassis.

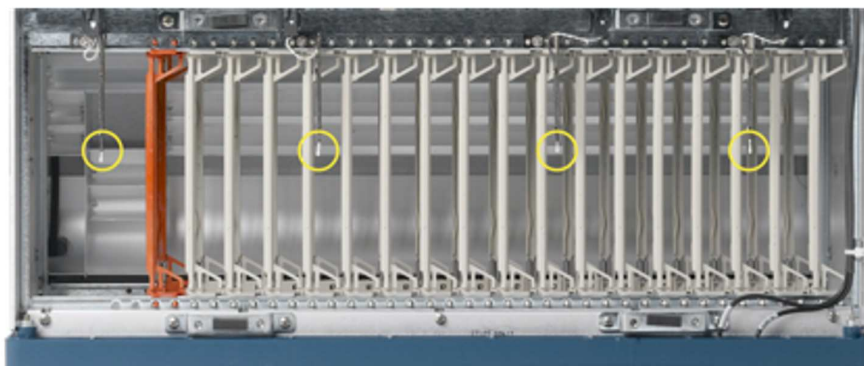

*Figure 2. PXIe-1085 chassis with top casing removed to show four outlet air temperature sensors (front of chassis is at bottom of image).*



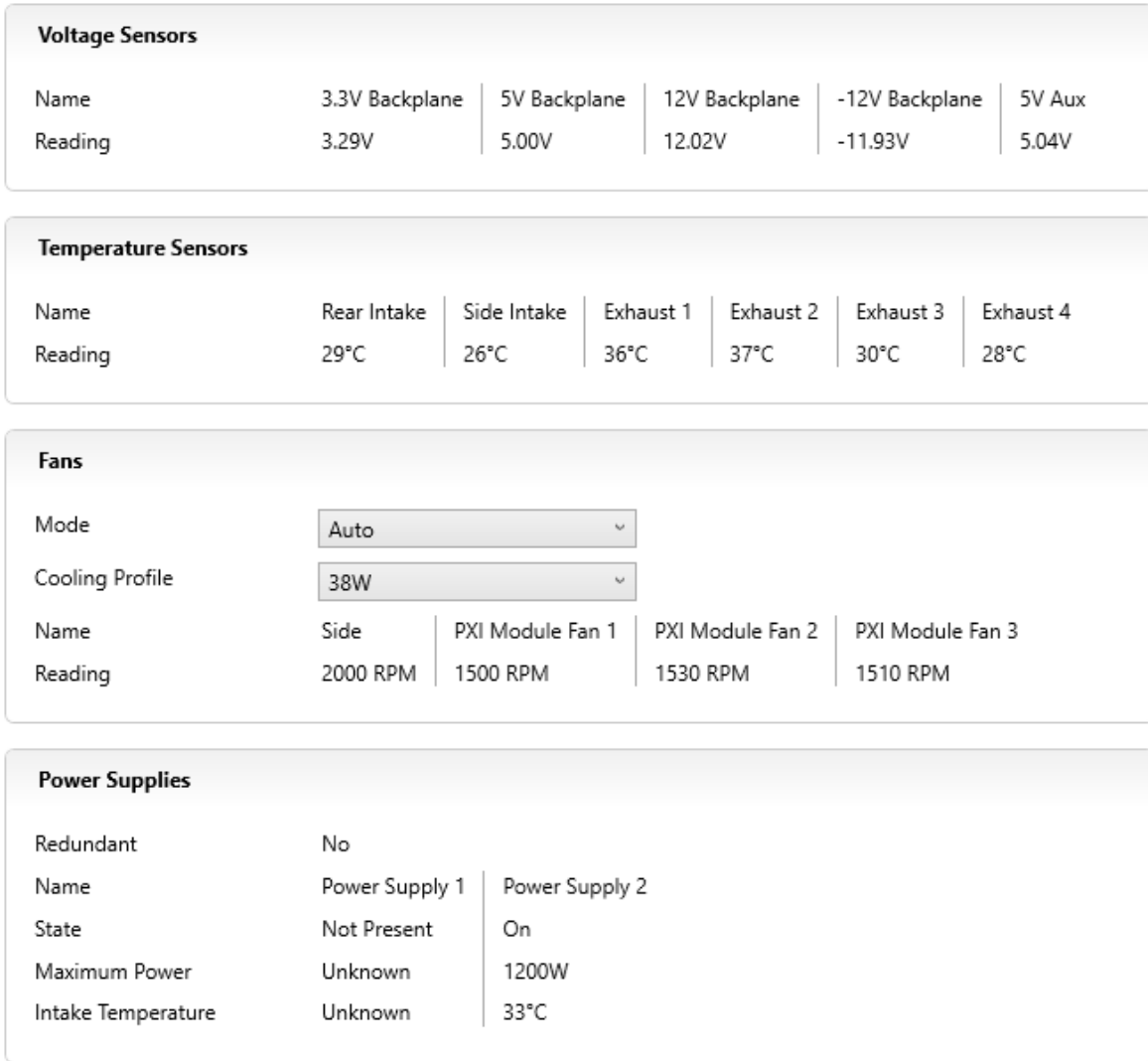

Figure 3. PXIe-1095 chassis sensors for voltage rails, temperature sensors, fan speed, and power supply temperature in NI MAX.

## Remote Inhibit and Fault Monitoring

Several chassis variants include terminals for remotely powering on or off the chassis or monitoring overall chassis health for any detected faults. For the PXIe-1095, PXIe-1092, and PXIe-1084 chassis, this functionality is included in the timing and synchronization upgrade option.

## Field-Replaceable Power Supplies

Instrumentation power supply failures are costly for most automated test systems. You can easily access, remove, and replace the PXIe-1095 power supplies for instance directly from the rear of the chassis to avoid de-racking the chassis or removing I/O connections.



Figure 4: PXIe-1095 power supplies are easily replaceable from the rear of the chassis.

## High Availability, Redundant Power Supplies and Fans

Some NI PXI chassis are designed specifically for maximizing uptime and system availability, resulting in a very low mean time to repair (MTTR). The PXIe-1086 for instance features both redundant, hot-swappable power supplies and fans.



Figure 5: PXIe-1086 with redundant, hot-swappable power supplies and fans for maximizing uptime

## 10 MHz REF Clock Connectors

When the 10 MHz Ref In connector on NI PXI chassis detects a signal, the backplane automatically phase locks the PXI\_CLK10, PXIe\_CLK100, and PXIe\_SYNC100 signals to this external clock and distributes these signals to the peripheral slots for synchronization.

Additionally, you can use the 10 MHz Ref Out connector to route the backplane's PXI\_CLK10 to another chassis for synchronization, or you can insert a timing and synchronization module (for example, the [PXIe-6674T](#)) in the system timing slot to drive the PXI\_CLK10 of the chassis with a higher stability clock.

The 10 MHz REF connectors on the PXIe-1095, PXIe-1092, and PXIe-1084 are included on the rear of the chassis as part of their timing and synchronization upgrade options.

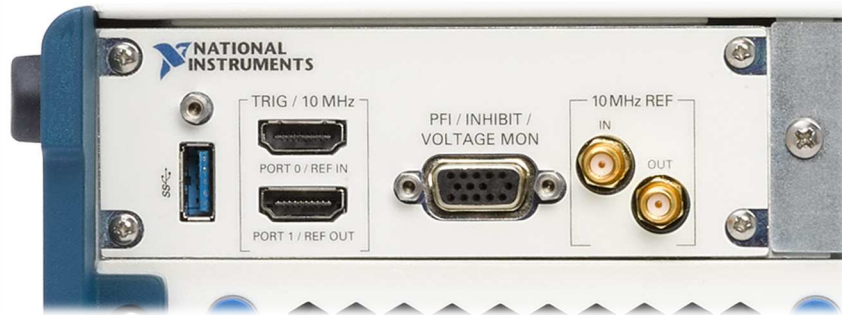

Figure 6. 10 MHz Reference In and Out SMA connectors on the PXIe-1095 chassis for multi-chassis synchronization

## Peer-to-Peer Streaming

Processing-intensive applications such as prototyping 5G wireless communications or performing real-time spectrum analysis (RTSA) warrant the addition of in-line, user-defined FPGA processing. NI PXI Express chassis and software enable peer-to-peer communication from a modular instrument to an FPGA module for in-line signal processing that bypasses the PXI embedded controller.

For more information, read the white paper: [Streaming Architecture of the Industry's Highest Performance PXI Express Platform](#).

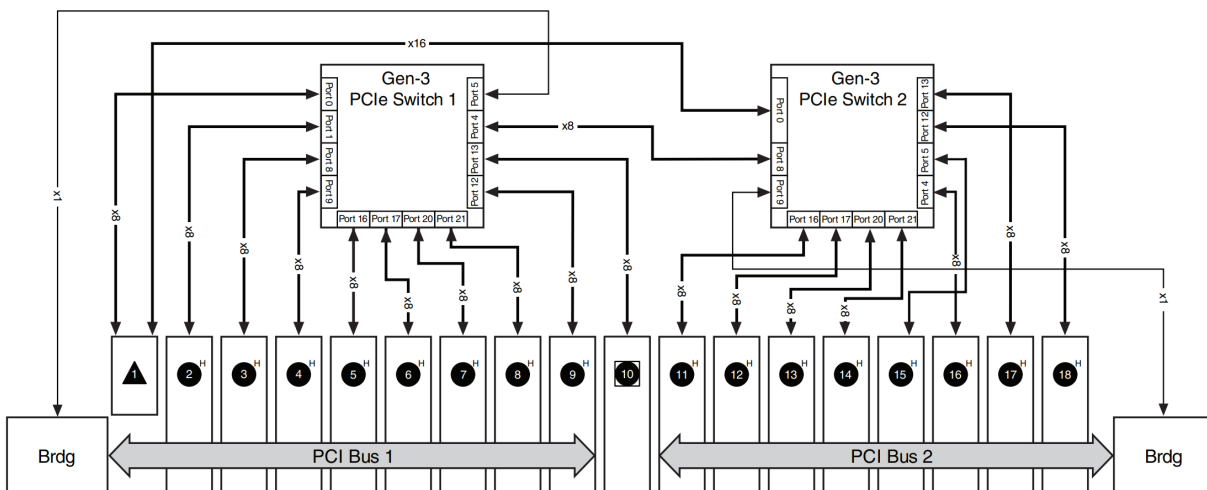

Figure 7. The PXIe-1085 24 GB/s chassis provides 8 GB/s peer-to-peer streaming bandwidth.

## Timing and Synchronization Quality

A key advantage of a PXI system is the integrated timing and synchronization capabilities. A PXI chassis incorporates a dedicated 10 MHz system reference clock, PXI trigger bus, star trigger bus, and slot-to-slot local bus, while a PXI Express chassis adds a 100 MHz differential system clock, differential signaling, and differential star triggers to address the need for advanced timing and synchronization.

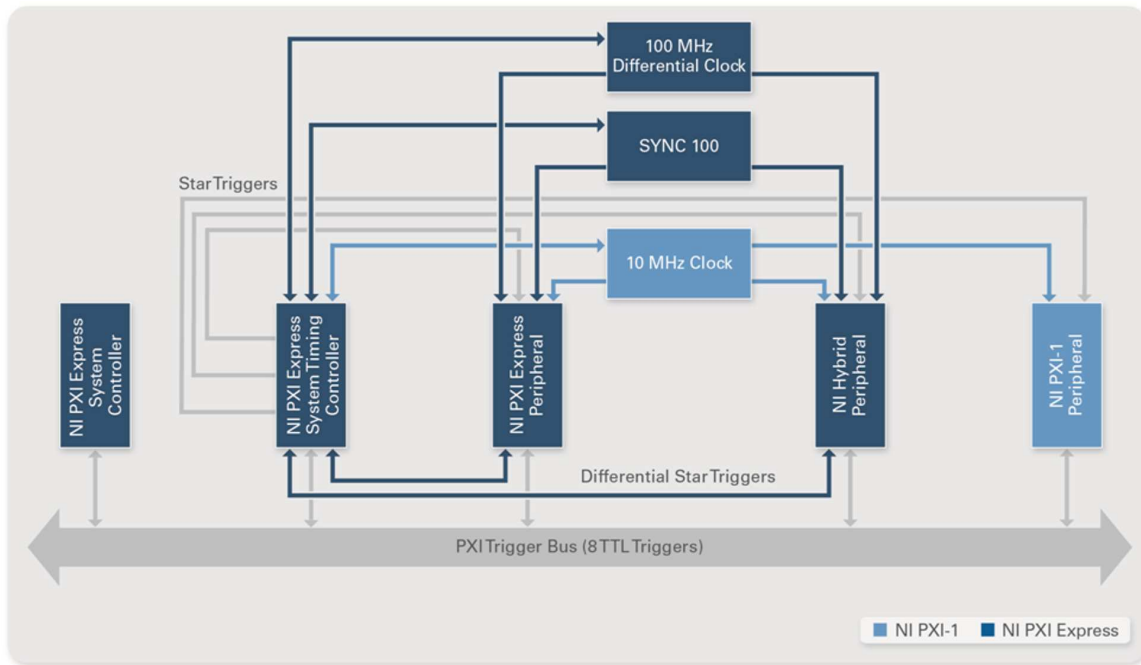

Figure 8. PXI Express backplane signal routing diagram

The phase noise and stability of the backplane system reference clocks are important characteristics of the PXI chassis, as they indicate how reliably you can expect to synchronize modules within the system. Given the choice of components and backplane design, phase noise performance of the PXI Express 100 MHz differential system clock on NI PXI Express chassis has performed orders of magnitude better than other vendors' chassis in the same class.

You can phase-lock-loop (PLL) the 10 MHz and 100 MHz system reference clocks to a higher stability clock source than that which is provided on the chassis backplane. This helps higher-sample-rate PXI modules to better align their samples across multiple instruments. The PLL circuitry of the NI PXI chassis is designed to suppress more noise when locking to an external reference, thus permitting cleaner transmission of the higher stability clock source. With other vendors' chassis, depending on the system clock source phase noise required by the application, you may need to phase-lock the external reference clock to each module individually rather than at a system level to the chassis backplane, resulting in an increase in system complexity and cost.

# PXIe Chassis Configuration and Monitoring Software

## NI MAX Configuration

The PXI Platform Services software included with your chassis automatically identifies your PXI Express system components to generate a pxiesys.ini file. You can configure your entire PXI system and identify PXI chassis through Measurement & Automation Explorer (NI MAX), included with your system controller. MAX creates the pxiesys.ini and pxisys.ini file, which define your PXI system parameters. MAX also provides an interface to route and reserve triggers so dynamic routing, through drivers such as DAQmx, avoids double-driving and potentially damaging trigger lines. For more information about routing and reserving PXI triggers, refer to [Knowledge Base 3TJDOND8](#).

The configuration steps for single or multichassis systems are the same.

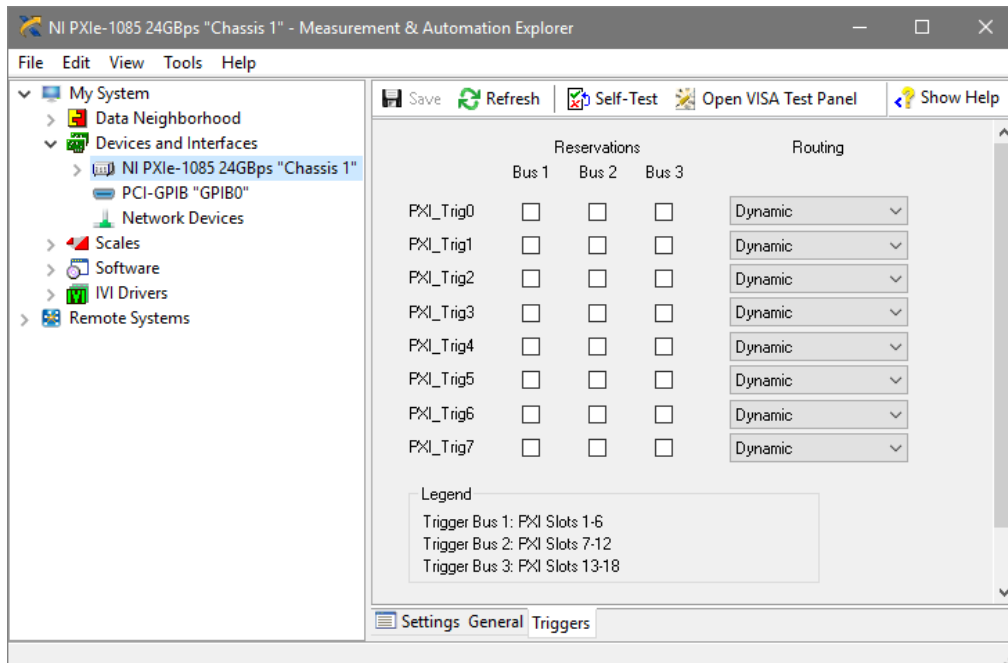



# System Configuration (API)

The System Configuration API gathers information about devices on both local and remote systems. Use the System Configuration API to programmatically reboot a system, save and load system images, install and uninstall software, and obtain information about a system like current temperature, fan speed, or calibration dates. You can find the System Configuration palette on the functions sub-palette in LabVIEW within the **Measurement I/O** palette.

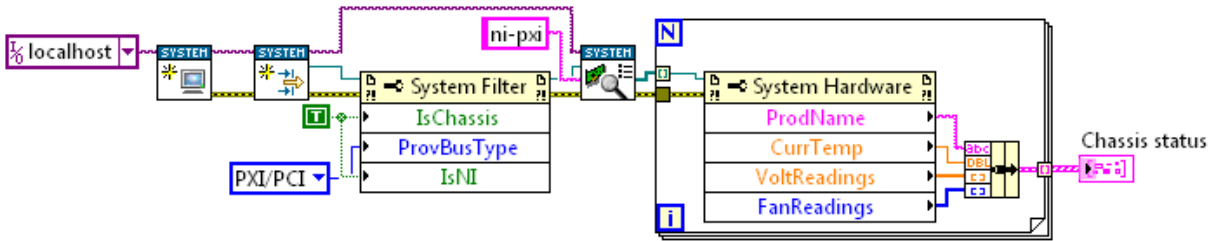

# Platform-Based Approach to Test and Measurement

## What Is PXI?

Powered by software, PXI is a rugged PC-based platform for measurement and automation systems. PXI combines PCI electrical-bus features with the modular, Eurocard packaging of CompactPCI and then adds specialized synchronization buses and key software features. PXI is both a high-performance and low-cost deployment platform for applications such as manufacturing test, military and aerospace, machine monitoring, automotive, and industrial test. Developed in 1997 and launched in 1998, PXI is an open industry standard governed by the PXI Systems Alliance (PXISA), a group of more than 70 companies chartered to promote the PXI standard, ensure interoperability, and maintain the PXI specification.

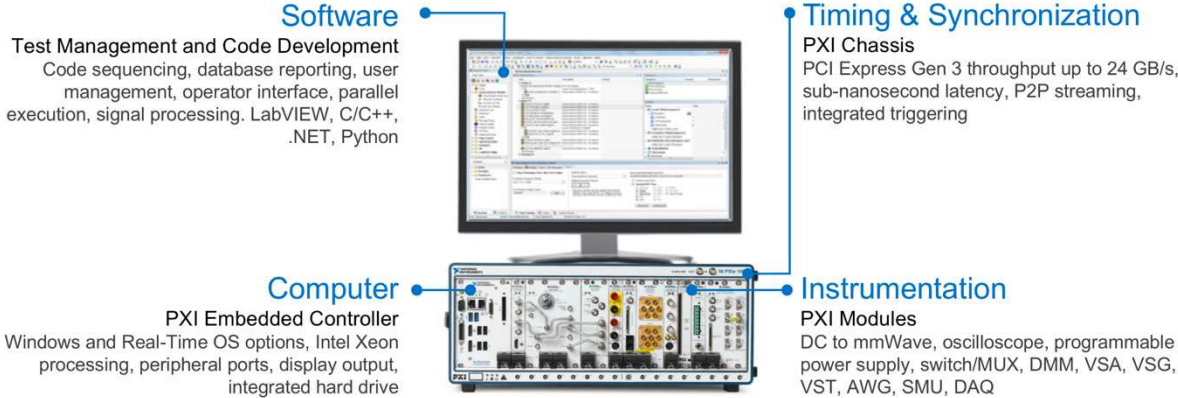

## Integrating the Latest Commercial Technology

By leveraging the latest commercial technology for our products, we can continually deliver high-performance and high-quality products to our users at a competitive price. The latest PCI Express Gen 3 switches deliver higher data throughput, the latest Intel multicore processors facilitate faster and more efficient parallel (multisite) testing, the latest FPGAs from Xilinx help to push signal processing algorithms to the edge to accelerate measurements, and the latest data converters from TI and ADI continually increase the measurement range and performance of our instrumentation.

<p>HIGHER DATA THROUGHPUT</p>  <p>PCI Express Gen 3</p>	<p>PARALLEL TEST EXECUTION</p>  <p>Multicore Processors</p>	<p>MEASUREMENT ACCELERATION</p>  <p>FPGAs</p>	<p>INCREASED MEASUREMENT RANGE</p>  <p>Data Converters</p>
--	--	---	---

# PXI Instrumentation

NI offers more than 600 different PXI modules ranging from DC to mmWave. Because PXI is an open industry standard, nearly 1,500 products are available from more than 70 different instrument vendors. With standard processing and control functions designated to a controller, PXI instruments need to contain only the actual instrumentation circuitry, which provides effective performance in a small footprint. Combined with a chassis and controller, PXI systems feature high-throughput data movement using PCI Express bus interfaces and sub-nanosecond synchronization with integrated timing and triggering.



## Oscilloscopes

Sample at speeds up to 12.5 GS/s with 5 GHz of analog bandwidth, featuring numerous triggering modes and deep onboard memory



## Digital Multimeters

Perform voltage (up to 1000 V), current (up to 3A), resistance, inductance, capacitance, and frequency/period measurements, as well as diode tests



## Digital Instruments

Perform characterization and production test of semiconductor devices with timing sets and per channel pin parametric measurement unit (PPMU)



## Waveform Generators

Generate standard functions including sine, square, triangle, and ramp as well as user-defined, arbitrary waveforms



## Frequency Counters

Perform counter timer tasks such as event counting and encoder position, period, pulse, and frequency measurements



## Source Measure Units

Combine high-precision source and measure capability with high channel density, deterministic hardware sequencing, and SourceAdapt transient optimization



## Power Supplies & Loads

Supply programmable DC power, with some modules including isolated channels, output disconnect functionality, and remote sense



## FlexRIO Custom Instruments & Processing

Provide high-performance I/O and powerful FPGAs for applications that require more than standard instruments can offer



## Switches (Matrix & MUX)

Feature a variety of relay types and row/column configurations to simplify wiring in automated test systems



## Vector Signal Transceivers

Combine a vector signal generator and vector signal analyzer with FPGA-based, real-time signal processing and control



## GPIB, Serial, & Ethernet

Integrate non-PXI instruments into a PXI system through various instrument control interfaces



## Data Acquisition Modules

Provide a mix of analog I/O, digital I/O, counter/timer, and trigger functionality for measuring electrical or physical phenomena

# Hardware Services

All NI hardware includes a one-year warranty for basic repair coverage, and calibration in adherence to NI specifications prior to shipment. PXI systems also include basic assembly and a functional test. NI offers additional entitlements to improve uptime and lower maintenance costs with service programs for hardware. Learn more at [ni.com/services/hardware](http://ni.com/services/hardware).

	Standard	Premium	Description
Program Duration	1, 3, or 5 years	1, 3, or 5 years	Length of service program
Extended Repair Coverage	•	•	NI restores your device's functionality and includes firmware updates and factory calibration.
System Configuration, Assembly, and Test <sup>1</sup>	•	•	NI technicians assemble, install software in, and test your system per your custom configuration prior to shipment.
Advanced Replacement <sup>2</sup>		•	NI stocks replacement hardware that can be shipped immediately if a repair is needed.
System Return Material Authorization (RMA) <sup>1</sup>		•	NI accepts the delivery of fully assembled systems when performing repair services.
Calibration Plan (Optional)	Standard	Expedited <sup>3</sup>	NI performs the requested level of calibration at the specified calibration interval for the duration of the service program.

<sup>1</sup>This option is only available for PXI, CompactRIO, and CompactDAQ systems.

<sup>2</sup>This option is not available for all products in all countries. Contact your local NI sales engineer to confirm availability.

<sup>3</sup>Expedited calibration only includes traceable levels.

## PremiumPlus Service Program

NI can customize the offerings listed above, or offer additional entitlements such as on-site calibration, custom sparring, and life-cycle services through a PremiumPlus Service Program. Contact your NI sales representative to learn more.

## Technical Support

Every NI system includes a 30-day trial for phone and e-mail support from NI engineers, which can be extended through a [Software Service Program \(SSP\)](#) membership. NI has more than 400 support engineers available around the globe to provide local support in more than 30 languages. Additionally, take advantage of NI's award winning [online resources](#) and [communities](#).

©2019 National Instruments. All rights reserved. LabVIEW, National Instruments, NI, NI TestStand, and ni.com are trademarks of National Instruments. Other product and company names listed are trademarks or trade names of their respective companies. The contents of this Site could contain technical inaccuracies, typographical errors or out-of-date information. Information may be updated or changed at any time, without notice. Visit [ni.com/manuals](http://ni.com/manuals) for the latest information.

10 December 2019