

## COMPREHENSIVE SERVICES

We offer competitive repair and calibration services, as well as easily accessible documentation and free downloadable resources.

## SELL YOUR SURPLUS

We buy new, used, decommissioned, and surplus parts from every NI series. We work out the best solution to suit your individual needs.

 Sell For Cash    Get Credit    Receive a Trade-In Deal

## OBSOLETE NI HARDWARE IN STOCK & READY TO SHIP

We stock **New**, **New Surplus**, **Refurbished**, and **Reconditioned** NI Hardware.



*Bridging the gap between the manufacturer and your legacy test system.*

 1-800-915-6216

 [www.apexwaves.com](http://www.apexwaves.com)

 [sales@apexwaves.com](mailto:sales@apexwaves.com)

*All trademarks, brands, and brand names are the property of their respective owners.*

**Request a Quote**

 **CLICK HERE**

**NI-9233**

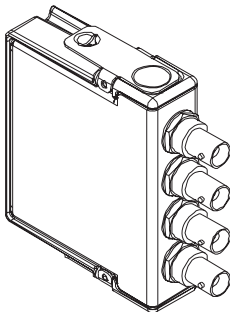
# OPERATING INSTRUCTIONS AND SPECIFICATIONS

# NI 9233

## 4-Channel, $\pm 5$ V, 24-Bit IEPE Analog Input Module

Français    Deutsch    日本語    한국어    简体中文

[ni.com/manuals](http://ni.com/manuals)



This document describes how to use the National Instruments 9233 and includes specifications and connector assignments for the NI 9233. Visit `ni.com/info` and enter `rdsoftwareversion` to determine which software you need for the modules you are using. For information about installing, configuring, and programming the system, refer to the system documentation. Visit `ni.com/info` and enter `cseriesdoc` for information about C Series documentation.



**Note** The safety guidelines and specifications in this document are specific to the NI 9233. The other components in the system might not meet the same safety ratings and specifications. Refer to the documentation for each component in the system to determine the safety ratings and specifications for the entire system. Visit `ni.com/info` and enter `cseriesdoc` for information about C Series documentation.

# Safety Guidelines

---

Operate the NI 9233 only as described in these operating instructions.



**Hot Surface** This icon denotes that the component may be hot. Touching this component may result in bodily injury.

## Safety Guidelines for Hazardous Locations

The NI 9233 is suitable for use in Class I, Division 2, Groups A, B, C, D, T4 hazardous locations; Class I, Zone 2, AEx nC IIC T4, and Ex nC IIC T4 hazardous locations; and nonhazardous locations only. Follow these guidelines if you are installing the NI 9233 in a potentially explosive environment. Not following these guidelines may result in serious injury or death.



**Caution** Do *not* disconnect I/O-side wires or connectors unless power has been switched off or the area is known to be nonhazardous.



**Caution** Do *not* remove modules unless power has been switched off or the area is known to be nonhazardous.



**Caution** Substitution of components may impair suitability for Class I, Division 2.



**Caution** For Zone 2 applications, install the system in an enclosure rated to at least IP 54 as defined by IEC 60529 and EN 60529.



**Caution** For Zone 2 applications, connected signals must be within the following limit:

Capacitance ..... 0.2  $\mu$ F max

## Special Conditions for Hazardous Locations Use in Europe

This equipment has been evaluated as EEx nC IIC T4 equipment under DEMKO Certificate No. 03 ATEX 0324020X. Each module is marked  $\text{Ex}$  II 3G and is suitable for use in Zone 2 hazardous locations. If you are using the NI 9233 in Gas Group IIC hazardous locations or in ambient temperatures of  $-40\text{ }^{\circ}\text{C} \leq T_a \leq 70\text{ }^{\circ}\text{C}$ , you must use the device in an NI chassis that has been evaluated as EEx nC IIC T4, Ex nA IIC T4, or Ex nL IIC T4 equipment.

## Special Conditions for Marine Applications

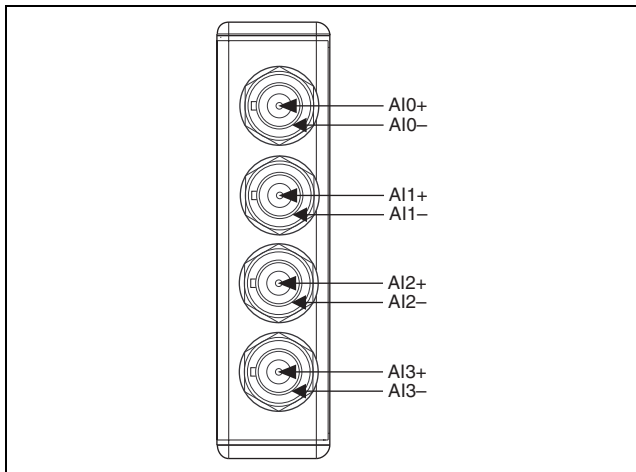
Some modules are Lloyd's Register (LR) Type Approved for marine applications. To verify Lloyd's Register certification, visit [ni.com/certification](http://ni.com/certification) and search for the LR certificate, or look for the Lloyd's Register mark on the module.



**Caution** To meet radio frequency emission requirements for marine applications, use shielded cables and install the system in a metal enclosure. Suppression ferrites must be installed on power supply inputs near power entries to modules and controllers. Power supply and module cables must be separated on opposite sides of the enclosure and must enter and exit through opposing enclosure walls.

# Connecting the NI 9233

The NI 9233 has four BNC connectors that provide connections for four simultaneously sampled analog input channels.



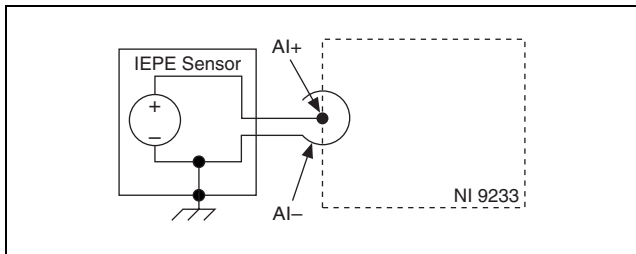
**Figure 1.** NI 9233 Connector Assignments

Each channel has a BNC connector to which you can connect an Integrated Electronic Piezoelectric (IEPE) sensor. The center pin of the connector, AI+, provides the DC excitation and the AC signal connection. The shell of the connector, AI-, provides the excitation return path and the AC signal ground reference.

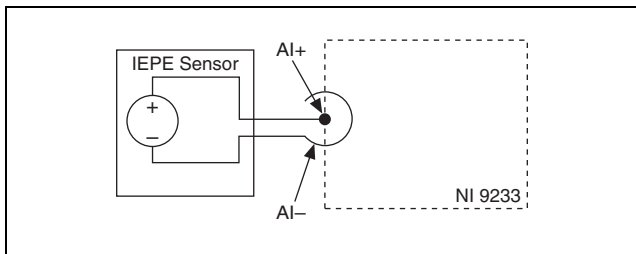
You can connect ground-referenced or floating IEPE sensors to the NI 9233. You can avoid picking up ground noise by using a floating connection. Typical IEPE sensors have a case that is electrically isolated from the IEPE electronics, so connecting the sensor to the NI 9233 results in a floating connection even though the case of the sensor is grounded. To further minimize ground noise, prevent the metal shells of the BNC connectors from touching each other, the modules, or the chassis.

If you make a ground-referenced connection between the IEPE sensor and the NI 9233, make sure the voltage on the AI- shell is in the common-mode range to ensure proper operation of the NI 9233. The AI- shell is protected against accidental contact with overvoltages within the overvoltage protection range. Refer to the [Specifications](#) section for more information about operating voltages and overvoltage protection. Figures 2 and 3 illustrate connecting grounded and floating IEPE sensors to the NI 9233.



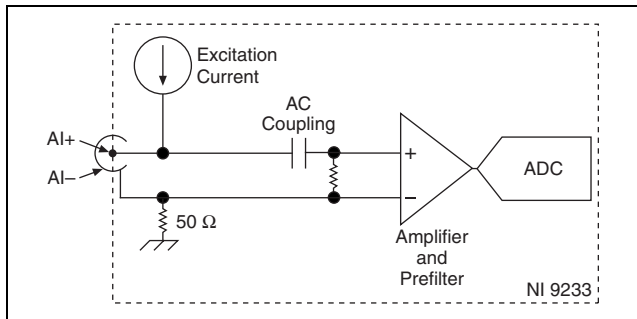


**Figure 2.** Connecting a Grounded IEPE Sensor to the NI 9233



**Figure 3.** Connecting a Floating IEPE Sensor to the NI 9233

The NI 9233 analog input channels are referenced to the chassis ground through a 50  $\Omega$  resistor. To minimize ground noise, make sure that the chassis ground is connected to the earth ground. Each channel is protected from overvoltages. The NI 9233 provides an IEPE excitation current for each input signal. The signal is AC-coupled, buffered, and conditioned. The signal is then sampled by a 24-bit Delta-Sigma ADC. The NI 9233 IEPE excitation current and AC coupling are always enabled. Refer to Figure 4 for an illustration of the input circuitry for one channel of the NI 9233.



**Figure 4.** Input Circuitry for One Channel of the NI 9233

The NI 9233 also has TEDS circuitry. For more information about TEDS, visit [ni.com/info](http://ni.com/info) and enter `rdteds`.

## Understanding NI 9233 Filtering

---

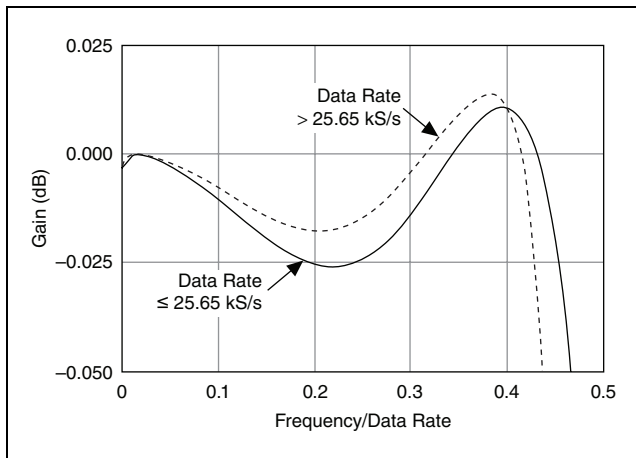
The NI 9233 uses a combination of analog and digital filtering to provide an accurate representation of in-band signals while rejecting out-of-band signals. The filters discriminate between signals based on the frequency range, or bandwidth, of the signal. The three important bandwidths to consider are the passband, the stopband, and the alias-free bandwidth.

The NI 9233 represents signals within the passband, as quantified primarily by passband flatness and phase nonlinearity. All signals that appear in the alias-free bandwidth are either unaliased signals or signals that have been filtered by at least the amount of the stopband rejection.

### Passband

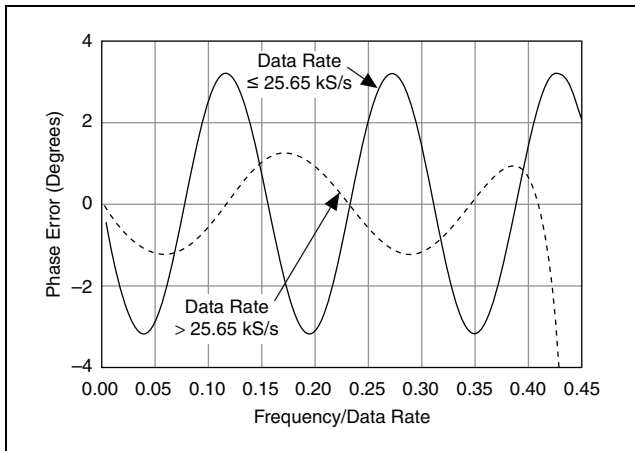
The signals within the passband have frequency-dependent gain or attenuation. The small amount of variation in gain with respect to frequency is called the passband flatness. The digital filters of the NI 9233 adjust the frequency range of the passband to match the data rate. Therefore, the amount of gain or attenuation at a given

frequency depends on the data rate. Figure 5 shows typical passband flatness for data rates above 25.65 kS/s and less than or equal to 25.65 kS/s.



**Figure 5.** Typical Passband Flatness for the NI 9233

The relative phases of these signals also have a frequency-dependent delay. The variation in the phase delay with frequency is called the phase nonlinearity. Figure 6 shows the phase nonlinearity for data rates above 25.65 kS/s and less than or equal to 25.65 kS/s. The phase nonlinearity scales directly with the oversample rate, so the two curves normalize the signal frequency to the data rate.



**Figure 6.** Phase Nonlinearity of the NI 9233

## Stopband

The filter significantly attenuates all signals above the stopband frequency. The primary goal of the filter is to prevent aliasing. Therefore, the stopband frequency scales precisely with the data rate. The stopband rejection is the minimum amount of attenuation applied by the filter to all signals with frequencies within the stopband.

## Alias-Free Bandwidth

Any signal that appears in the alias-free bandwidth of the NI 9233 is not an aliased artifact of signals at a higher frequency. The alias-free bandwidth is defined by the ability of the filter to reject frequencies above the stopband frequency and it is equal to the data rate minus the stopband frequency.

## Understanding NI 9233 Data Rates

---

The frequency of a master timebase ( $f_M$ ) controls the data rate ( $f_s$ ) of the NI 9233. The NI 9233 includes an internal master timebase with a frequency of 12.8 MHz, but the module also can accept an external master timebase or export its own master timebase. To synchronize the data rate of an NI 9233 with other modules that use master timebases to control sampling, all of the modules must

share a single master timebase source. Refer to the software help for information about configuring the master timebase source for the NI 9233. Visit [ni.com/info](http://ni.com/info) and enter `cseriesdoc` for information about C Series documentation.

The following equations provide the available data rates of the NI 9233:

$$\text{When } f_s \text{ is } \leq 25.65 \text{ kS/s, } f_s = \frac{f_M \div 256}{n}$$

where  $n$  is any integer from 2 to 25.

$$\text{When } f_s \text{ is } > 25.65 \text{ kS/s, } f_s = \frac{f_M \div 128}{n}$$

where  $n$  is any integer from 2 to 3.

However, the data rate must remain within the appropriate data rate range. Refer to the [Specifications](#) section for more information about the data rate range. When using the internal master timebase of 12.8 MHz, the result is data rates of 50 kS/s, 33.33 kS/s, 25 kS/s, and so on down to 2.0 kS/s, depending on the value of  $n$ . When using an external timebase with a frequency other than 12.8 MHz, the NI 9233 has a different set of data rates.





**Note** The cRIO-9151 R Series Expansion chassis does not support sharing timebases between modules.

## Sleep Mode

---

This module supports a low-power sleep mode. Support for sleep mode at the system level depends on the chassis that the module is plugged into. Refer to the chassis manual for information about support for sleep mode. If the chassis supports sleep mode, refer to the software help for information about enabling sleep mode. Visit [ni.com/info](http://ni.com/info) and enter `cseriesdoc` for information about C Series documentation.

Typically, when a system is in sleep mode, you cannot communicate with the modules. In sleep mode, the system consumes minimal power and may dissipate less heat than it does in normal mode. Refer to the *Specifications* section for more information about power consumption and thermal dissipation.

# Specifications

---

The following specifications are typical for the range  $-40$  to  $70$  °C unless otherwise noted.

## Input Characteristics

|  |   |
|--|---|
| Number of channels .....                                 | 4 analog input channels                   |
| ADC resolution .....                                     | 24 bits                                   |
| Type of ADC.....   | Delta-Sigma<br>(with analog prefiltering) |
| Sampling mode .....                                      | Simultaneous                              |
| Internal master timebase ( $f_M$ )                       |   |
| Frequency .....  | 12.8 MHz                                  |
| Accuracy.....  | $\pm 100$ ppm max                         |
| Data rate range ( $f_s$ ) using internal master timebase |   |
| Minimum.....   | 2.0 kS/s                                  |
| Maximum .....  | 50 kS/s                                   |
| Data rate range ( $f_s$ ) using external master timebase |   |
| Minimum.....   | 2.0 kS/s                                  |
| Maximum .....  | 51.3 kS/s                                 |

## Data rates<sup>1</sup> ( $f_s$ )

$$f_s \leq 25.65 \text{ kS/s} \dots\dots\dots \frac{f_M \div 256}{n}, n = 2, 3, \dots, 25$$

$$f_s > 25.65 \text{ kS/s} \dots\dots\dots \frac{f_M \div 128}{n}, n = 2, 3$$

Input coupling..... AC

### AC cutoff frequency

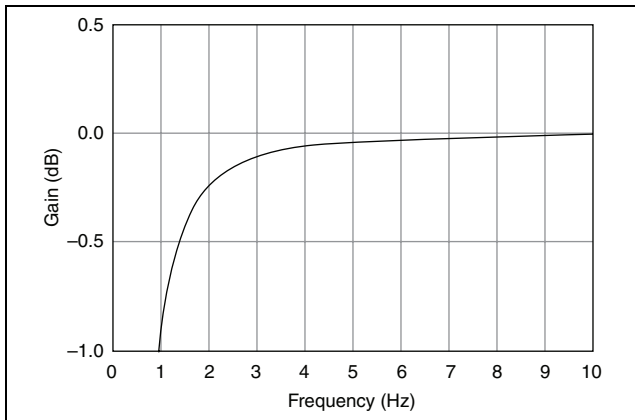
-3 dB ..... 0.5 Hz typ

-0.1 dB ..... 4.2 Hz max

---

<sup>1</sup> The data rate must remain within the appropriate data rate range. Refer to the [Understanding NI 9233 Data Rates](#) section for more information.

## AC cutoff frequency response



Input range .....  $\pm 5$  V

AC voltage full-scale range

Minimum .....  $\pm 5$  V<sub>pk</sub>

Typical .....  $\pm 5.4$  V<sub>pk</sub>

Maximum .....  $\pm 5.8$  V<sub>pk</sub>

Common-mode voltage range  
(AI- to earth ground).....  $\pm 2$  V max

IEPE excitation current

Minimum..... 2.0 mA

Typical..... 2.2 mA

IEPE compliance voltage..... 19 V max

Use the following equation to make sure that your configuration meets the IEPE compliance voltage range.

$$V_{common-mode} + V_{bias} \pm V_{full-scale} \text{ must be } 0 \text{ to } 19.$$

where  $V_{common-mode}$  is any common-mode voltage applied to the NI 9233,

$V_{bias}$  is the bias voltage of the accelerometer, and

$V_{full-scale}$  is the full-scale voltage of the accelerometer.

## Overvoltage protection (with respect to chassis ground)

For an IEPE sensor connected  
to AI+ and AI- .....  $\pm 30$  V

For a low-impedance source  
connected to AI+ and AI- .....  $-6$  to  $30$  V

## Input delay

$\leq 25.65$  kS/s .....  $12.8/f_s + 3$   $\mu$ s

$> 25.65$  kS/s .....  $9.8/f_s + 3$   $\mu$ s

## Accuracy ( $-40$ to $70$ °C)

Calibrated typ .....  $\pm 0.1$  dB

Calibrated max .....  $\pm 0.3$  dB

Uncalibrated max .....  $\pm 0.6$  dB

## Accuracy drift

Typical .....  $0.001$  dB/°C

Maximum .....  $0.0045$  dB/°C

## Channel-to-channel matching

### Gain

Typical..... 0.07 dB

Maximum..... 0.27 dB

Phase ( $f_{in}$  in kHz).....  $f_{in} \cdot 0.077^\circ + 0.067^\circ$

### Passband

#### Flatness (pk-to-pk max)

$f_s \leq 25.65$  kS/s..... 0.05 dB (10 Hz to  $0.45 \cdot f_s$ )

$f_s > 25.65$  kS/s..... 0.05 dB (10 Hz to  $0.42 \cdot f_s$ )

#### Phase nonlinearity

$f_s \leq 25.65$  kS/s.....  $\pm 3.4^\circ$  (10 Hz to  $0.45 \cdot f_s$ )

$f_s > 25.65$  kS/s.....  $\pm 1.3^\circ$  (20 Hz to  $0.41 \cdot f_s$ )

| $f_s$             | Stopband         |             | Oversample Rate | Alias-Free Bandwidth |
|-------------------|------------------|-------------|-----------------|----------------------|
|                   | Freq             | Attenuation |                 |                      |
| $\leq 25.65$ kS/s | $0.58 \cdot f_s$ | 95 dB       | $128 \cdot f_s$ | $0.42 \cdot f_s$     |
| $> 25.65$ kS/s    | $0.68 \cdot f_s$ | 92 dB       | $64 \cdot f_s$  | $0.32 \cdot f_s$     |

### Crosstalk ( $f_{in} = 1$ kHz)

Paired channels

(0 and 1, 2 and 3).....-100 dB

Nonpaired channels .....-110 dB

### CMRR ( $f_{in} \leq 1$ kHz)

Minimum ..... 44 dB

Typical ..... 56 dB

SFDR ( $f_{in} = 1$  kHz, -60 dBFS) ..... 120 dB

### Idle channel noise and noise density

| Idle Channel  | 50 kS/s                    | 25 kS/s                    | 2 kS/s                     |
|---------------|----------------------------|----------------------------|----------------------------|
| Noise         | 95 dBFS                    | 98 dBFS                    | 102 dBFS                   |
| Noise density | 400 nV/ $\sqrt{\text{Hz}}$ | 400 nV/ $\sqrt{\text{Hz}}$ | 900 nV/ $\sqrt{\text{Hz}}$ |

### Input impedance

Differential (AC) ..... >300 k $\Omega$

AI- (shield) to chassis ground.... 50  $\Omega$



## Total harmonic distortion (THD)

| <b>Input Amplitude</b> | <b>1 kHz,<br/>-40 to 70 °C</b> | <b>10 kHz,<br/>25 to 70 °C</b> | <b>10 kHz,<br/>-40 to 25 °C</b> |
|------------------------|--------------------------------|--------------------------------|---------------------------------|
| -1 dBFS                | -90 dB                         | -80 dB                         | -80 dB                          |
| -20 dBFS               | -95 dB                         | -90 dB                         | -80 dB                          |

## Intermodulation distortion (-1 dBFS)

DIN 250 Hz/8 kHz

4:1 amplitude ratio ..... -80 dB

CCIF 11 kHz/12 kHz

1:1 amplitude ratio ..... -93 dB

MTBF ..... 397,465 hours at 25 °C;  
Bellcore Issue 2, Method 1,  
Case 3, Limited Part Stress  
Method



**Note** Contact NI for Bellcore MTBF specifications at other temperatures or for MIL-HDBK-217F specifications.

## Power Requirements

Power consumption from chassis

Active mode ..... 620 mW max

Sleep mode ..... 0.5 mW max

Thermal dissipation (at 70 °C)

Active mode ..... 640 mW max

Sleep mode ..... 0.5 mW max

## Physical Characteristics

If you need to clean the module, wipe it with a dry towel.

Weight ..... 173 g (6.1 oz)

## Safety

### Safety Voltages

Connect only voltages that are within the following limits.

Channel-to-earth ground .....  $\pm 30$  V max

Isolation

Channel-to-channel ..... None

Channel-to-earth ground ..... None

## Hazardous Locations

|                     |   |
|---------------------|---|
| U.S. (UL) .....     | Class I, Division 2,<br>Groups A, B, C, D, T4;<br>Class I, Zone 2,<br>AEx nC IIC T4 |
| Canada (C-UL) ..... | Class I, Division 2,<br>Groups A, B, C, D, T4;<br>Class I, Zone 2,<br>Ex nC IIC T4  |
| Europe (DEMKO)..... | EEx nC IIC T4   |

## Safety Standards

This product meets the requirements of the following standards of safety for electrical equipment for measurement, control, and laboratory use:

- IEC 61010-1, EN 61010-1
- UL 61010-1, CSA 61010-1



**Note** For UL and other safety certifications, refer to the product label or the [Online Product Certification](#) section.

## Electromagnetic Compatibility

This product meets the requirements of the following EMC standards for electrical equipment for measurement, control, and laboratory use:

- EN 61326 (IEC 61326): Class A emissions; Industrial immunity
- EN 55011 (CISPR 11): Group 1, Class A emissions
- AS/NZS CISPR 11: Group 1, Class A emissions
- FCC 47 CFR Part 15B: Class A emissions
- ICES-001: Class A emissions



**Note** For the standards applied to assess the EMC of this product, refer to the [Online Product Certification](#) section.



**Note** For EMC compliance, operate this device with shielded cabling.

## CE Compliance

This product meets the essential requirements of applicable European Directives as follows:

- 2006/95/EC; Low-Voltage Directive (safety)
- 2004/108/EC; Electromagnetic Compatibility Directive (EMC)

## Online Product Certification

Refer to the product Declaration of Conformity (DoC) for additional regulatory compliance information. To obtain product certifications and the DoC for this product, visit [ni.com/certification](http://ni.com/certification), search by module number or product line, and click the appropriate link in the Certification column.

## Shock and Vibration

To meet these specifications, you must panel mount the system.

Operating vibration

Random (IEC 60068-2-64)..... 5  $g_{rms}$ , 10 to 500 Hz

Sinusoidal (IEC 60068-2-6) ..... 5 g, 10 to 500 Hz

|  |  |
|--|--|
| Operating shock<br>(IEC 60068-2-27)..... | 30 g, 11 ms half sine,<br>50 g, 3 ms half sine,<br>18 shocks at 6 orientations |
|--|--|

## Environmental

National Instruments C Series modules are intended for indoor use only but may be used outdoors if installed in a suitable enclosure. Refer to the manual for the chassis you are using for more information about meeting these specifications.

|   |              |
|---|--------------|
| Operating temperature<br>(IEC 60068-2-1, IEC 60068-2-2) ..... | -40 to 70 °C |
|---|--------------|

|   |              |
|---|--------------|
| Storage temperature<br>(IEC 60068-2-1, IEC 60068-2-2) ..... | -40 to 85 °C |
|---|--------------|

|                         |       |
|-------------------------|-------|
| Ingress protection..... | IP 40 |
|-------------------------|-------|

|   |                                |
|---|--------------------------------|
| Operating humidity<br>(IEC 60068-2-56)..... | 10 to 90% RH,<br>noncondensing |
|---|--------------------------------|

|   |                               |
|---|-------------------------------|
| Storage humidity<br>(IEC 60068-2-56)..... | 5 to 95% RH,<br>noncondensing |
|---|-------------------------------|

Maximum altitude.....2,000 m

Pollution Degree (IEC 60664) ..... 2

## Environmental Management

NI is committed to designing and manufacturing products in an environmentally responsible manner. NI recognizes that eliminating certain hazardous substances from our products is beneficial to the environment and to NI customers.

For additional environmental information, refer to the *NI and the Environment* Web page at [ni.com/environment](http://ni.com/environment). This page contains the environmental regulations and directives with which NI complies, as well as other environmental information not included in this document.

## Waste Electrical and Electronic Equipment (WEEE)



**EU Customers** At the end of the life cycle, all products *must* be sent to a WEEE recycling center. For more information about WEEE recycling centers and National Instruments WEEE initiatives, visit [ni.com/environment/weee](http://ni.com/environment/weee).

## 电子信息产品污染控制管理办法（中国 RoHS）



**中国客户** National Instruments 符合中国电子信息产品中限制使用某些有害物质指令 (RoHS)。关于 National Instruments 中国 RoHS 合规性信息，请登录 [ni.com/environment/rohs\\_china](http://ni.com/environment/rohs_china)。(For information about China RoHS compliance, go to [ni.com/environment/rohs\\_china](http://ni.com/environment/rohs_china).)

## Calibration

You can obtain the calibration certificate and information about calibration services for the NI 9233 at [ni.com/calibration](http://ni.com/calibration).

Calibration interval ..... 1 year



## Where to Go for Support

---

The National Instruments Web site is your complete resource for technical support. At [ni.com/support](http://ni.com/support) you have access to everything from troubleshooting and application development self-help resources to email and phone assistance from NI Application Engineers.

National Instruments corporate headquarters is located at 11500 North Mopac Expressway, Austin, Texas, 78759-3504. National Instruments also has offices located around the world to help address your support needs. For telephone support in the United States, create your service request at [ni.com/support](http://ni.com/support) and follow the calling instructions or dial 512 795 8248. For telephone support outside the United States, contact your local branch office:

Australia 1800 300 800, Austria 43 662 457990-0,  
Belgium 32 (0) 2 757 0020, Brazil 55 11 3262 3599,  
Canada 800 433 3488, China 86 21 5050 9800,  
Czech Republic 420 224 235 774, Denmark 45 45 76 26 00,  
Finland 358 (0) 9 725 72511, France 01 57 66 24 24,  
Germany 49 89 7413130, India 91 80 41190000,  
Israel 972 3 6393737, Italy 39 02 41309277, Japan 0120-527196,

Korea 82 02 3451 3400, Lebanon 961 (0) 1 33 28 28,  
Malaysia 1800 887710, Mexico 01 800 010 0793,  
Netherlands 31 (0) 348 433 466, New Zealand 0800 553 322,  
Norway 47 (0) 66 90 76 60, Poland 48 22 3390150,  
Portugal 351 210 311 210, Russia 7 495 783 6851,  
Singapore 1800 226 5886, Slovenia 386 3 425 42 00,  
South Africa 27 0 11 805 8197, Spain 34 91 640 0085,  
Sweden 46 (0) 8 587 895 00, Switzerland 41 56 2005151,  
Taiwan 886 02 2377 2222, Thailand 662 278 6777,  
Turkey 90 212 279 3031, United Kingdom 44 (0) 1635 523545

National Instruments, NI, ni.com, and LabVIEW are trademarks of National Instruments Corporation. Refer to the *Terms of Use* section on [ni.com/legal](http://ni.com/legal) for more information about National Instruments trademarks. Other product and company names mentioned herein are trademarks or trade names of their respective companies. For patents covering National Instruments products/technology, refer to the appropriate location: **Help»Patents** in your software, the `patents.txt` file on your media, or the *National Instruments Patent Notice* at [ni.com/patents](http://ni.com/patents).

© 2004–2008 National Instruments Corp. All rights reserved.