

COMPREHENSIVE SERVICES

We offer competitive repair and calibration services, as well as easily accessible documentation and free downloadable resources.

SELL YOUR SURPLUS

We buy new, used, decommissioned, and surplus parts from every NI series. We work out the best solution to suit your individual needs.

 Sell For Cash  Get Credit  Receive a Trade-In Deal

OBSOLETE NI HARDWARE IN STOCK & READY TO SHIP

We stock **New**, **New Surplus**, **Refurbished**, and **Reconditioned** NI Hardware.



Bridging the gap between the manufacturer and your legacy test system.

 1-800-915-6216

 www.apexwaves.com

 sales@apexwaves.com

All trademarks, brands, and brand names are the property of their respective owners.

Request a Quote

 **CLICK HERE**

PCI-7390

Getting Started with NI-Motion™ for NI 73xx Motion Controllers

This document provides instructions for installing and getting started with the NI-Motion driver software and National Instruments PXI/PCI-73xx motion controllers. Refer to the user manual or technical reference material that came with your computer for specific instructions about the computer.

Refer to the [Where to Go for Support](#) section at the end of this document for a list of the documents included with the NI-Motion driver software and the NI 73xx motion controller.

What You Need to Get Started

The following items are necessary for getting started with the NI 73xx motion controller.

Hardware

- A computer with an available PXI or PCI slot
- NI 73xx motion controller
- NI or third-party drive and motor

Software

- NI-Motion driver software
- One of the following software packages and documentation:
 - LabVIEW
 - LabWindows™/CVI™
 - Microsoft Visual C++
 - Microsoft Visual Basic
- (Optional) NI Motion Assistant

Related Documentation

The following documents contain additional information that you may find helpful. All referenced documents ship with the product and are available at ni.com/manuals.

- *NI 73xx motion controller user manuals*—Describes the electrical and mechanical aspects of the NI 73xx motion controller, and contains information about installing and operating the device.
- *NI-Motion Help*—Contains information about selecting a motor, designing a basic move, designing a multi-axis move, incorporating image and data acquisition into motion applications, and working with common motion concepts, such as contouring and breakpoints. This document is task-based and takes you through each phase of designing and executing a motion application.
- *NI-Motion Readme*—Contains system requirements, installation instructions, descriptions of any changes made to the software, information about new features in the release, and information about late-breaking known issues that are not documented in other NI-Motion documents.

- *NI-Motion Function Help*—Contains function reference files for C and Visual Basic and provides details about each function, including a description of the function, a list of the function parameters, illustrations, and error codes.
- *NI-Motion VI Help*—Contains LabVIEW VI reference files and provides details about each VI, including VI descriptions, lists of control and input terminals, usage, illustrations, and error codes.
- *Measurement & Automation Explorer Help for Motion*—Provides information about using MAX to configure the NI 73xx motion controller as well as some advanced conceptual information about topics such as Bode analysis and control loop parameters.
- *Getting Started with NI 7340/7350 Motion Controllers and AKD Servo Drives*—Explains how to install and configure the AKD servo drives for use with the NI 7340 and NI 7350 motion controllers.
- *Getting Started with NI 7330/7340/7350 Motion Controllers and P7000 Series Stepper Drives*—Explains how to install and configure the P7000 series stepper drives for use with NI 7330, 7340, and NI 7350 motion controllers.

Safety Information



Caution The following section contains important safety information that you *must* follow when installing and using the device.

Do *not* operate the device in a manner not specified in this document. Misuse of the device can result in a hazard. You can compromise the safety protection built into the device if the device is damaged in any way. If the device is damaged, return it to National Instruments (NI) for repair.

Do *not* substitute parts or modify the device except as described in this document. Use the device only with the chassis, modules, accessories, and cables specified in the installation instructions. You *must* have all covers and filler panels installed during operation of the device.

Do *not* operate the device in an explosive atmosphere or where there may be flammable gases or fumes. If you must operate the device in such an environment, it must be in a suitably rated enclosure.

If you need to clean the device, use a soft, nonmetallic brush. Make sure that the device is completely dry and free from contaminants before returning it to service.

Operate the device only at or below Pollution Degree 2. Pollution is foreign matter in a solid, liquid, or gaseous state that can reduce dielectric strength or surface resistivity. The following is a description of pollution degrees:

- Pollution Degree 1 means no pollution or only dry, nonconductive pollution occurs. The pollution has no influence.
- Pollution Degree 2 means that only nonconductive pollution occurs in most cases. Occasionally, however, a temporary conductivity caused by condensation must be expected.
- Pollution Degree 3 means that conductive pollution occurs, or dry, nonconductive pollution occurs that becomes conductive due to condensation.



Note NI 73xx devices are intended for indoor use only.

You *must* insulate signal connections for the maximum voltage for which the device is rated. Do *not* exceed the maximum ratings for the device. Do not install wiring while the device is live with electrical signals. Do not remove or add connector blocks when power is connected to the system. Remove power from signal lines before connecting them to or disconnecting them from the device.

Operate the device at or below the measurement category¹ marked on the hardware label. Measurement circuits are subjected to *working voltages*² and transient stresses (overvoltage) from the circuit to which they are connected during measurement or test. Installation categories establish standard impulse withstand voltage levels that commonly occur in electrical distribution systems. The following is a description of measurement categories:

- Measurement Category I is for measurements performed on circuits not directly connected to the electrical distribution system referred to as MAINS³ voltage. This category is for measurements of voltages from specially protected secondary circuits. Such voltage measurements include signal levels, special equipment, limited-energy parts of equipment, circuits powered by regulated low-voltage sources, and electronics.
- Measurement Category II is for measurements performed on circuits directly connected to the electrical distribution system. This category refers to local-level electrical distribution, such as that provided by a standard wall outlet (for example, 115 AC voltage for U.S. or 230 AC voltage for Europe). Examples of Installation Category II are measurements performed on household appliances, portable tools, and similar devices/modules.
- Measurement Category III is for measurements performed in the building installation at the distribution level. This category refers to measurements on hard-wired equipment such as equipment in fixed installations, distribution boards, and circuit breakers. Other examples are wiring, including cables, bus bars, junction boxes, switches, socket outlets in the fixed installation, and stationary motors with permanent connections to fixed installations.
- Measurement Category IV is for measurements performed at the primary electrical supply installation (<1,000 V). Examples include electricity meters and measurements on primary overcurrent protection devices and on ripple control units.

Installing NI-Motion

You must install the application software and the NI-Motion driver software *before* installing an NI 73xx motion controller for the first time. If you are upgrading from a previous version of NI-Motion, it is not necessary to remove the NI 73xx controller before installing the upgrade. The upgrade does not affect the existing Microsoft Windows configuration.



Tip Refer to the `NI-Motion ReadMe.htm` file for last-minute information about NI-Motion.

Complete the following steps to install the NI-Motion driver software:

1. Insert the NI-Motion CD into the CD-ROM drive to display the NI-Motion installation screen.
2. If you have autorun enabled, `autorun.exe` runs automatically. Otherwise, double-click `autorun.exe`.
3. Follow the onscreen instructions.



Note You must update the firmware on your NI 73xx controller(s) before you can use them with the corresponding version of NI-Motion. Refer to the [Firmware Updates](#) section for detailed instructions.

¹ Measurement categories, also referred to as *installation categories*, are defined in electrical safety standard IEC 61010-1.

² Working voltage is the highest rms value of an AC or DC voltage that can occur across any particular insulation.

³ MAINS is defined as a hazardous live electrical supply system that powers equipment. Suitably rated measuring circuits may be connected to the MAINS for measuring purposes.

Installing the NI 73xx Motion Controller

The following sections explain how to install PXI and PCI motion controllers.



Note When adding or removing a controller from a Windows Vista/XP/2000 system, you must be logged on with administrator-level access. After you have restarted the system, you may need to refresh Measurement & Automation Explorer (MAX) to view the new controller.

PXI Motion Controllers

1. Power off and unplug the chassis.



Caution To protect yourself and the computer from electrical hazards, the computer *must* remain unplugged until the installation is complete.

2. Choose an unused peripheral slot and remove the filler panel.
3. Touch a metal part on the chassis to discharge any static electricity.
4. Insert the NI 73xx motion controller into the PXI slot as shown in Figure 1. Use the injector/ejector handle to fully secure the device into place.

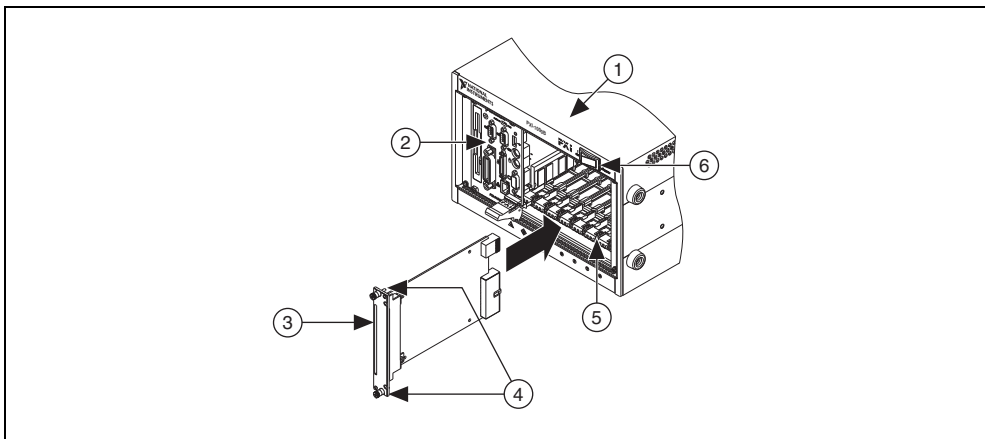

1 PXI Chassis	4 Front-Panel Mounting Screws
2 PXI System Controller	5 Module Guides
3 NI 73xx Motion Controller	6 Power Switch

Figure 1. Installing an NI 73xx Motion Controller in a PXI Chassis

5. Attach the front panel of the NI 73xx motion controller to the front panel mounting rails of the chassis with the slot screws on the chassis.



Caution Make sure you have correctly connected all safety devices before you power on the motion system. Safety devices include inhibits, limit switches, and emergency shut down circuits.



Caution Always power on the computer containing the NI 73xx motion controller and initialize the controller before you power on the rest of the motion system. Power off the motion system in the reverse order.

6. Plug in and power on the chassis.

PCI Motion Controllers

1. Power off and unplug the computer.



Caution To protect yourself and the computer from electrical hazards, the computer *must* remain unplugged until the installation is complete.

2. Open the computer case to expose access to the PCI expansion slots.
3. Touch a metal part on the chassis to discharge any static electricity.
4. Choose an unused +3.3 V or +5 V PCI slot, and remove the corresponding expansion slot cover on the back panel of the computer.



Caution Do *not* insert or remove an NI PCI-7390 motion controller from your system without first disconnecting the +24 V power supplies from all NI PCI-7390 devices. Failure to do so may result in damage to your system and/or NI PCI-7390.

5. Gently rock the controller into the slot. The connection may be tight, but do *not* force the controller into place.



Note Check that the bracket of the device aligns with the hole in the back panel rail of the computer chassis.

6. Secure the mounting bracket of the controller to the back panel rail of the computer.
7. Replace the cover.



Caution Make sure you have correctly connected all safety devices before you power on the motion system. Safety devices include inhibits, limit switches, and emergency shut down circuits.



Caution Always power on the computer containing the NI 73xx motion controller, then, if applicable, the +24 V external power supply, and then initialize the controller before you power on the rest of the motion system. Power off the motion system in the reverse order.

8. Plug in and power on the computer.

Firmware Updates

Firmware is software that is loaded onto the NI 73xx motion controller. Firmware allows you to update the NI 73xx motion controller with new features and updates. The latest firmware is automatically installed on the computer when you install the latest version of NI-Motion. You must download the firmware to the NI 73xx motion controller.

Complete the following steps to download firmware to an NI 73xx motion controller:



1. Click the MAX icon on the desktop, or select **Start»All Programs»National Instruments»Measurement & Automation** to open MAX.



2. Expand **Devices and Interfaces**, and then expand **NI Motion Devices** in the configuration tree.

3. Select the motion controller for which you want to download firmware. An exclamation point on the NI 73xx motion controller icon indicates that the firmware is outdated and must be updated.

4. Click the **Firmware** tab at the bottom of the window. An exclamation point appears for each firmware sector that requires an update.

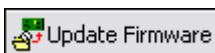

5. Click the **Update Firmware** button at the top of the window to update all the firmware files on your device.



Tip To find NI-Motion updates, visit ni.com/motion and select **Drivers & Downloads**. For support questions, visit ni.com/support/motion.

LabVIEW Real-Time Module Setup

Using NI 73xx motion controllers with the LabVIEW Real-Time Module and a remote PXI system is very similar to using NI-Motion with an NI PCI-73xx motion controller in the host machine. The only difference is that you must map the remote PXI system to the local machine in MAX before you configure and initialize the motion system. Figure 2 shows a remote NI 73xx motion controller mapped to the local machine. The IP address in the device name indicates that it is a remote device.

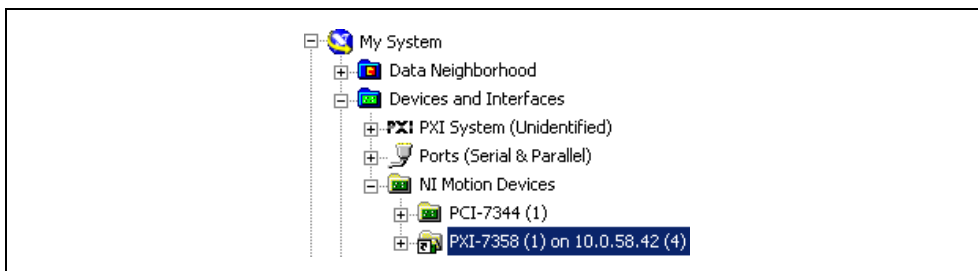

Figure 2. Mapped Remote NI 73xx Controller

When the NI 73xx motion controller is initialized, you can create a deterministic, real-time motion control application using the LabVIEW Real-Time Module and target the application to the remote device in the PXI system. Refer to the *Remote Systems* topic in the *Measurement & Automation Explorer Help for Motion* for information about mapping the remote system to the local machine.

Configuring the Motion Control System

Before you configure a motion control system, install the motion hardware, including the NI 73xx motion controller, motors, drives, encoders, Universal Motion Interface (if necessary), limits, and home switches. Refer to the appropriate hardware documentation for installation instructions.



Note You must have a complete hardware setup to configure and test a servo motion control system.



Note National Instruments recommends you connect the NI 73xx motion controller Axis Inhibit outputs to the drive. Inhibit outputs are typically used to disable a servo or stepper drive for power saving, safety, or specific application reasons. Refer to the *Measurement & Automation Explorer Help for Motion* for information about inhibit outputs.

If you are using the NI 73xx motion controller with an AKD analog servo drive and AKM motor available from NI, refer to the *Getting Started with NI 7340/7350 Motion Controllers and AKD Servo Drives* for detailed system installation and configuration instructions.

If you are using the NI 73xx motion controller with a P7000 series stepper drive and stepper motor available from NI, refer to the *Getting Started with NI 7330/7340/7350 Motion Controllers and P7000 Series Stepper Drives*— for detailed system installation and configuration instructions.

National Instruments recommends you use MAX to configure and test the motion control system. Refer to the *Measurement and Automation Explorer Help for Motion* for step-by-step configuration procedures.

NI Motion Assistant

National Instruments Motion Assistant is a graphical prototyping tool you can use to prototype motion control applications. Motion Assistant contains the following features: simple and complex moves, graphical prototyping, and code creation.

Simple and Complex Moves

Motion Assistant offers several move types that represent the most often used moves in motion control. Supported moves include the following:

- Reference moves include home and index moves.
- Straight-line moves create simple point-to-point movement for basic motion applications.
- Arc moves enable circular, three-dimensional, and helical arc types.
- Contouring moves allow any trajectory specified by a series of coordinates.
- CAD moves create a move profile based on an imported CAD file.

Graphical Prototyping

Motion Assistant is a fully graphical interface that makes it easy for you to prototype a motion application by creating a series of moves. The position, velocity, and acceleration of the moves are all graphed and editable in two and three dimensions.

Code Creation

When you are finished creating a prototype of a motion control application, you can use the Motion Assistant code creation feature to export LabVIEW or C/C++ code. You can use the exported code to complete the application in LabVIEW, C, or C++. You also can use Motion Assistant to generate code recipes that you can use to code a motion control application in other text languages, such as Microsoft Visual Basic.

The code generation feature of Motion Assistant also creates placeholders in the generated code or code recipes for non-motion code, such as data or image acquisition, in any location you specify.

Advanced Features

Motion Assistant supports the digital output and position compare output features that are available on NI 73xx motion controllers. These features are designed to be used with motion control to synchronize or coordinate external processes with moves.

The digital output feature allows you to write to an ancillary digital output line on the NI 73xx motion controller under the following move conditions:

- Before Move Completes
- After Move Completes
- After Blend Completes

The position compare output feature allows you to write to the position compare output lines on the NI 73xx motion controller at a specified position in the move. If you are using an NI 7350 motion controller, you can configure multiple or periodic position compare outputs. Both options add multiple position compare outputs to a single move.

Hardware Support

Motion Assistant requires that either the actual controller or the virtual representation of an NI 73xx motion controller be installed in the computer. Refer to the *Motion Assistant Help* for more information.

Using Motion Assistant Without Hardware

If you do not have an NI 73xx motion controller, you can use a virtual NI 73xx motion controller in MAX to preview the functionality of Motion Assistant. Follow the instructions in the *Motion Assistant Help* to install a virtual NI 73xx motion controller.

Where to Go for Support

The National Instruments Web site is your complete resource for technical support. At ni.com/support you have access to everything from troubleshooting and application development self-help resources to email and phone assistance from NI Application Engineers.

Visit ni.com/services for NI Factory Installation Services, repairs, extended warranty, calibration, and other services.

Visit ni.com/register to register your National Instruments product. Product registration facilitates technical support and ensures that you receive important information updates from NI.

A Declaration of Conformity (DoC) is our claim of compliance with the Council of the European Communities using the manufacturer's declaration of conformity. This system affords the user protection for electromagnetic compatibility (EMC) and product safety. You can obtain the DoC for your product by visiting ni.com/certification. If your product supports calibration, you can obtain the calibration certificate for your product at ni.com/calibration.

National Instruments corporate headquarters is located at 11500 North Mopac Expressway, Austin, Texas, 78759-3504. National Instruments also has offices located around the world to help address your support needs. For telephone support in the United States, create your service request at ni.com/support and follow the calling instructions or dial 512 795 8248. For telephone support outside the United States, visit the Worldwide Offices section of ni.com/niglobal to access the branch office Web sites, which provide up-to-date contact information, support phone numbers, email addresses, and current events.

电子信息产品污染控制管理办法（中国 RoHS）



中国客户 National Instruments 符合中国电子信息产品中限制使用某些有害物质指令 (RoHS)。关于 National Instruments 中国 RoHS 合规性信息, 请登录 ni.com/environment/rohs_china。(For information about China RoHS compliance, go to ni.com/environment/rohs_china.)

CVI, LabVIEW, National Instruments, NI, ni.com, the National Instruments corporate logo, and the Eagle logo are trademarks of National Instruments Corporation. Refer to the *Trademark Information* at ni.com/trademarks for other National Instruments trademarks. The mark LabWindows is used under a license from Microsoft Corporation. Windows is a registered trademark of Microsoft Corporation in the United States and other countries. Other product and company names mentioned herein are trademarks or trade names of their respective companies. For patents covering National Instruments products/technology, refer to the appropriate location: **Help»Patents** in your software, the `patents.txt` file on your media, or the *National Instruments Patent Notice* at ni.com/patents. Refer to the *Export Compliance Information* at ni.com/legal/export-compliance for the National Instruments global trade compliance policy.