

COMPREHENSIVE SERVICES

We offer competitive repair and calibration services, as well as easily accessible documentation and free downloadable resources.

SELL YOUR SURPLUS

We buy new, used, decommissioned, and surplus parts from every NI series. We work out the best solution to suit your individual needs.

 Sell For Cash  Get Credit  Receive a Trade-In Deal

OBSOLETE NI HARDWARE IN STOCK & READY TO SHIP

We stock **New**, **New Surplus**, **Refurbished**, and **Reconditioned** NI Hardware.



Bridging the gap between the manufacturer and your legacy test system.

 1-800-915-6216

 www.apexwaves.com

 sales@apexwaves.com

All trademarks, brands, and brand names are the property of their respective owners.

Request a Quote

 **CLICK HERE**

cRIO-9101

NI cRIO-9101/9102/9103/9104

CompactRIO Reconfigurable Embedded Chassis

Figure 1. CompactRIO Eight-Slot and Four-Slot Reconfigurable Embedded Systems

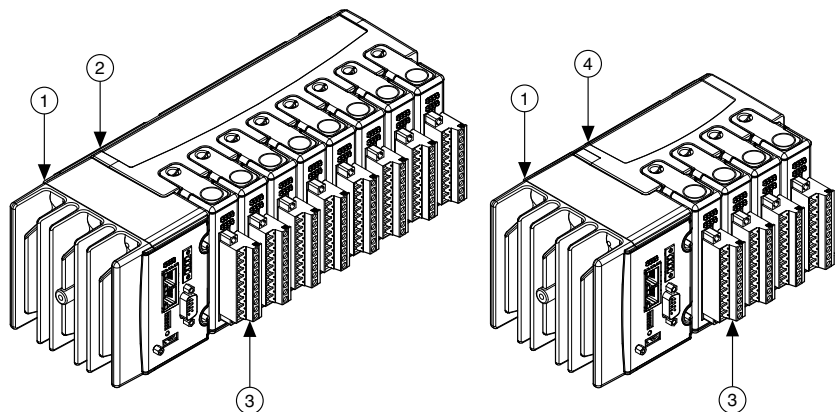

- | | |
|--|---|
| 1. Controller | 3. C Series I/O Module |
| 2. Eight-Slot Reconfigurable Embedded Chassis (cRIO-9102/9104) | 4. Four-Slot Reconfigurable Embedded Chassis (cRIO-9101/9103) |

This document describes how to install an NI cRIO-9101, cRIO-9102, cRIO-9103, or cRIO-9104. In this document the NI cRIO-9101, cRIO-9102, cRIO-9103, and cRIO-9104 are inclusively referred to as the cRIO-910x.

Safety Guidelines



Caution Do not operate the chassis in a manner not specified in this document. Product misuse can result in a hazard. You can compromise the safety protection built into the product if the product is damaged in any way. If the product is damaged, return it to NI for repair.

Safety Guidelines for Hazardous Locations

The chassis is suitable for use in Class I, Division 2, Groups A, B, C, D, T4 hazardous locations; Class I, Zone 2, AEx nA IIC T4 and Ex nA IIC T4 hazardous locations; and nonhazardous locations only. Follow these guidelines if you are installing the chassis in a

potentially explosive environment. Not following these guidelines may result in serious injury or death.



Caution Do not disconnect I/O-side wires or connectors unless power has been switched off or the area is known to be nonhazardous.



Caution Do not remove modules unless power has been switched off or the area is known to be nonhazardous.



Caution Substitution of components may impair suitability for Class I, Division 2.



Caution For Division 2 and Zone 2 applications, install the system in an enclosure rated to at least IP54 as defined by IEC/EN 60079-15.

Special Conditions for Hazardous Locations Use in Europe and Internationally

The chassis has been evaluated as Ex nA IIC T4 Gc equipment under DEMKO Certificate No. 03 ATEX 0324020X and is IECEx UL 14.0089X certified. Each device is marked Ⓢ II 3G and is suitable for use in Zone 2 hazardous locations, in ambient temperatures of $-40\text{ °C} \leq T_a \leq 70\text{ °C}$.



Caution You must make sure that transient disturbances do not exceed 140% of the rated voltage.



Caution The system shall only be used in an area of not more than Pollution Degree 2, as defined in IEC 60664-1.



Caution The system shall be mounted in an ATEX/IECEx-certified enclosure with a minimum ingress protection rating of at least IP54 as defined in IEC/EN 60079-15.



Caution The enclosure must have a door or cover accessible only by the use of a tool.

Electromagnetic Compatibility Guidelines

This product was tested and complies with the regulatory requirements and limits for electromagnetic compatibility (EMC) stated in the product specifications. These requirements and limits provide reasonable protection against harmful interference when the product is operated in the intended operational electromagnetic environment.

This product is intended for use in industrial locations. However, harmful interference may occur in some installations, when the product is connected to a peripheral device or test object, or if the product is used in residential or commercial areas. To minimize interference with radio and television reception and prevent unacceptable performance degradation, install and use this product in strict accordance with the instructions in the product documentation.

Furthermore, any changes or modifications to the product not expressly approved by National Instruments could void your authority to operate it under your local regulatory rules.

Special Conditions for Marine Applications

Some products are Lloyd's Register (LR) Type Approved for marine (shipboard) applications. To verify Lloyd's Register certification for a product, visit ni.com/certification and search for the LR certificate, or look for the Lloyd's Register mark on the product.



Caution In order to meet the EMC requirements for marine applications, install the product in a shielded enclosure with shielded and/or filtered power and input/output ports. In addition, take precautions when designing, selecting, and installing measurement probes and cables to ensure that the desired EMC performance is attained.

What You Need to Install the CompactRIO System

- CompactRIO reconfigurable embedded chassis
- CompactRIO intelligent real-time embedded controller
- C Series I/O modules
- Mounting hardware if needed (available from NI)
- Two M4 or number 10 panhead screws (for panel mounting only)
- Number 2 Philips screwdriver
- Power supply
- Ethernet cable
- Documentation (available on ni.com/manuals)
 - cRIO controller documentation—learn how to connect the controller to a network and configure the controller.
 - C Series modules documentation—learn about module specifications and how to use the modules.

What You Need to Start Using the CompactRIO System

After you install the CompactRIO chassis, controller, and C Series modules, you need the following things to start using the CompactRIO system:

- Windows computer with LabVIEW and NI-RIO software installed
- ni.com/gettingstarted—learn how to install, set up, and configure your CompactRIO hardware and learn the basics of LabVIEW software.
- *LabVIEW Help*—access information about LabVIEW programming concepts, step-by-step instructions for using LabVIEW, and reference information about LabVIEW VIs, functions, palettes, menus, tools, properties, methods, events, dialog boxes, and so on.

Installing the Controller on the Chassis

Complete the following steps to install the controller on the chassis.

1. Make sure that no power is connected to the controller or the chassis.
2. Align the controller with the chassis.

Figure 2. Installing the Controller on the Chassis (Eight-Slot Chassis Shown)

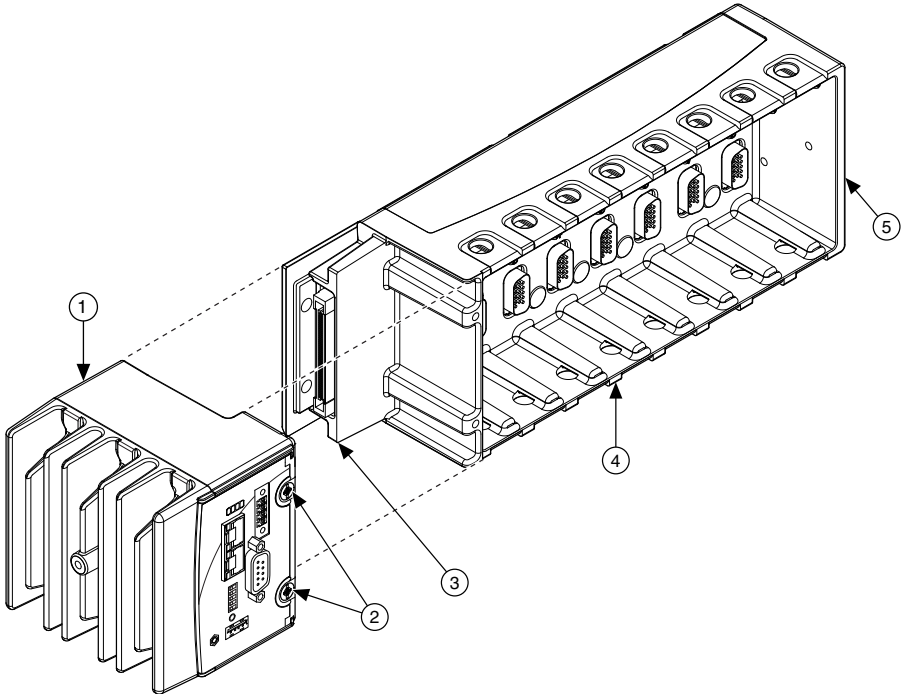

1. Controller
2. Captive Screws
3. Controller Slot
4. Reconfigurable Embedded Chassis
5. Grounding Screw

3. Slide the controller onto the controller slot on the chassis. Press firmly to ensure the chassis connector and the controller connector are mated.
4. Using a number 2 Phillips screwdriver, tighten the two captive screws on the front of the controller to $1.3 \text{ N} \cdot \text{m}$ ($11.5 \text{ lb} \cdot \text{in.}$) of torque.

Mounting the CompactRIO Reconfigurable Embedded Chassis

You can mount the chassis in any orientation on a 35 mm DIN rail or on a panel. Use the DIN rail mounting method if you already have a DIN rail configuration or if you need to be able to quickly remove the CompactRIO chassis. Use the panel mount method for high shock and vibration applications.

Go to ni.com/info and enter the info code `criomounting` to learn more about the different mounting methods for CompactRIO.

Before using any of the mounting methods, record the serial number from the back of the chassis. You will be unable to read the serial number after you have mounted the chassis.



Caution Before you mount the chassis, make sure that I/O modules are not in the chassis.



Caution Your installation must meet the following requirements for space and cabling clearance:

- Allow 25.4 mm (1 in.) on the top and the bottom of the chassis for air circulation.
- Allow 50.8 mm (2 in.) in front of modules for cabling clearance for common connectors, such as the 10-terminal, detachable screw-terminal connector.

Go to ni.com/info and enter `rdcrioconn` to find the minimum cabling clearance for C Series modules with other connector types.



Note Go to ni.com/dimensions for more information about the dimensions of the CompactRIO system, including detailed dimensional drawings.

The following figures show the dimensions of the four- and eight-slot chassis.

Figure 3. Four-Slot Reconfigurable Embedded Chassis with the Controller and I/O Modules Installed, Bottom and Side View with Dimensions

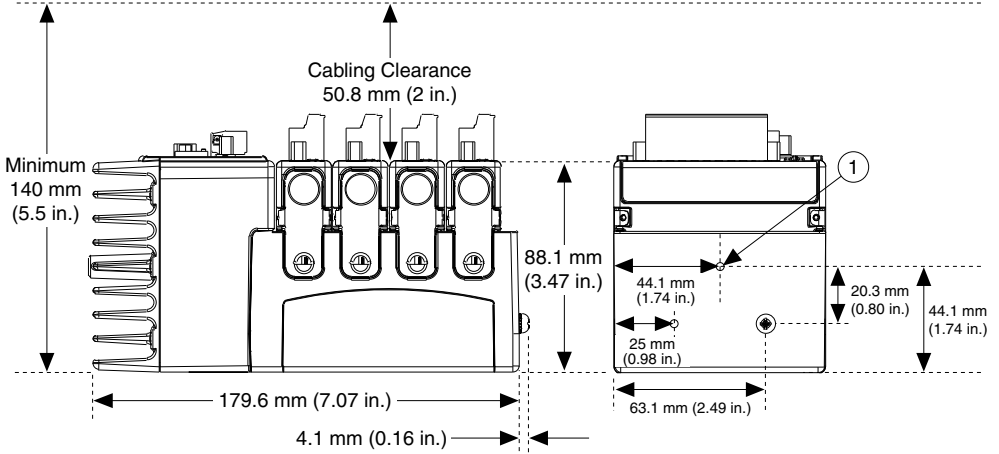

1. M4 Thread

Figure 4. Eight-Slot Reconfigurable Embedded Chassis with the Controller and I/O Modules Installed, Bottom View with Dimensions

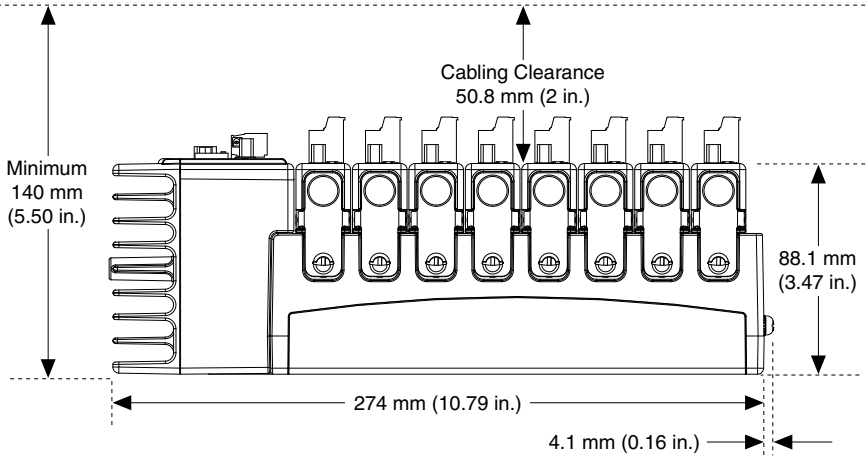

Figure 5. Four-Slot Reconfigurable Embedded Chassis with the Controller Installed, Front View with Dimensions

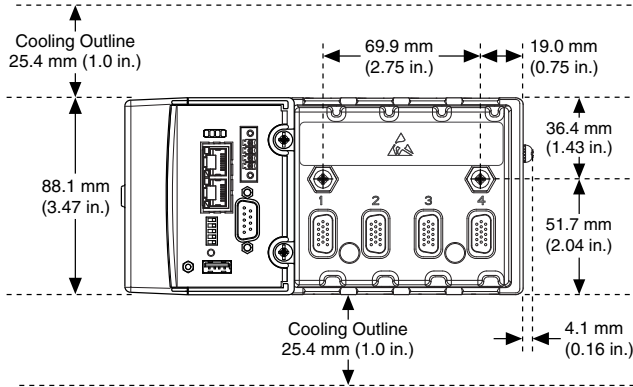
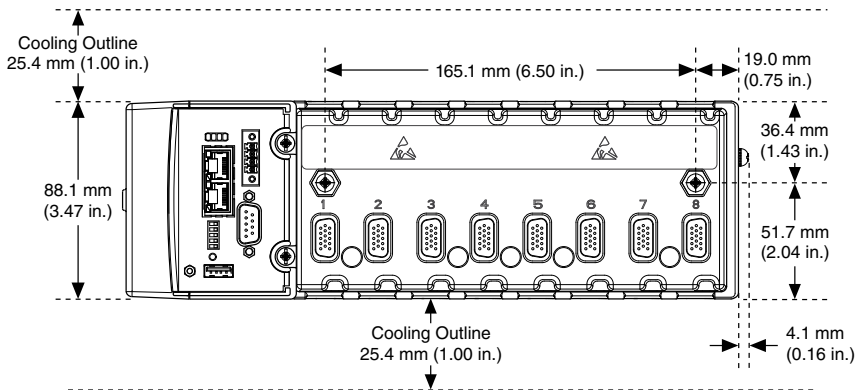

Figure 6. Eight-Slot Reconfigurable Embedded Chassis with the Controller Installed, Front View with Dimensions



Mounting the Chassis on a Panel

Complete the following steps to mount the chassis on a panel.

1. Align the chassis on the panel.
2. Bolt or screw the chassis to the panel using two M4 or number 10 panhead screws. NI does not provide the screws with the chassis.

Figure 7. Mounting a Four-Slot Chassis on a Panel

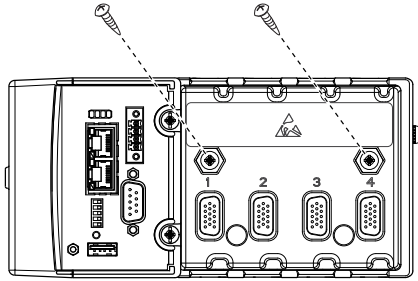
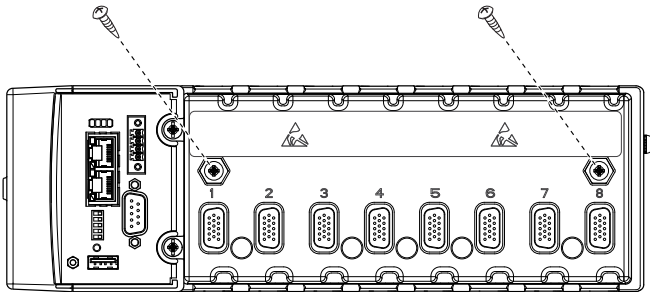

Figure 8. Mounting an Eight-Slot Chassis on a Panel



Caution If you are using the NI 9904/9905 panel mount kit, you must use the M4 × 22 screws included in the kit to attach the chassis to the kit.



Caution Remove the I/O modules from the chassis before removing the chassis from the panel.

Mounting the Chassis on a DIN Rail

You can order the NI 9912 DIN rail mount kit if you want to mount a four-slot CompactRIO chassis on a DIN rail, or the NI 9915 DIN rail mount kit if you want to mount an eight-slot CompactRIO chassis on a DIN rail. You need one clip for mounting the chassis on a standard 35 mm DIN rail. Complete the following steps to mount the chassis on a DIN rail.

1. Fasten the DIN rail clip to the chassis using a number 2 Phillips screwdriver and two M4 × 22 screws. The screws are included in the DIN rail mount kit.

Figure 9. Fastening the DIN Rail Clip to a Four-Slot Chassis

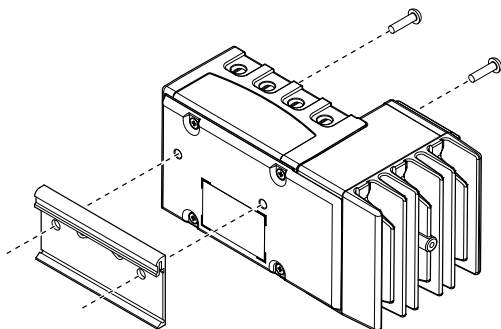
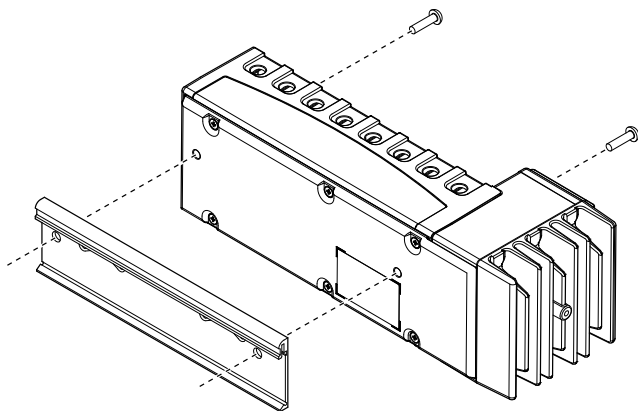
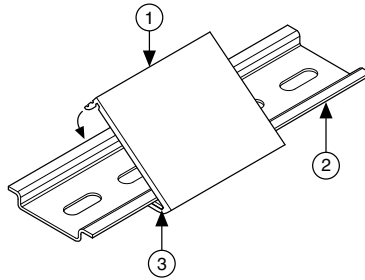

Figure 10. Fastening the DIN Rail Clip to an Eight-Slot Chassis



2. Insert one edge of the DIN rail into the deeper opening of the DIN rail clip.

Figure 11. Attaching the DIN Rail Clip to the DIN Rail



1. DIN Rail Clip
 2. DIN Rail
 3. DIN Rail Spring
3. Press down firmly on the chassis to compress the spring until the clip locks in place on the DIN rail.



Caution Remove the I/O modules before removing the chassis from the DIN rail.

Installing C Series I/O Modules in the Chassis

Figure 12. C Series I/O Module, Side and Front View with Dimensions

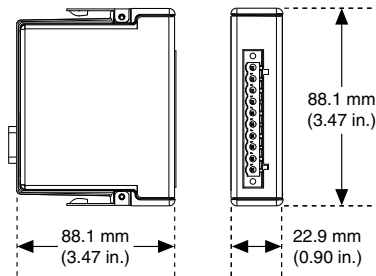

Note Modules with different connector types have different dimensions. Go to ni.com/info and enter `rdcrioconn` for more information about the different connector types.

Complete the following steps to install a C Series I/O module in the chassis.

1. Make sure that no I/O-side power is connected to the I/O module. If the system is in a nonhazardous location, the chassis power can be on when you install I/O modules.
2. Align the I/O module with an I/O module slot in the chassis. The module slots are labeled 1 to 8, left to right.

Figure 13. Installing an I/O Module in the Chassis (Eight-Slot Chassis Shown)

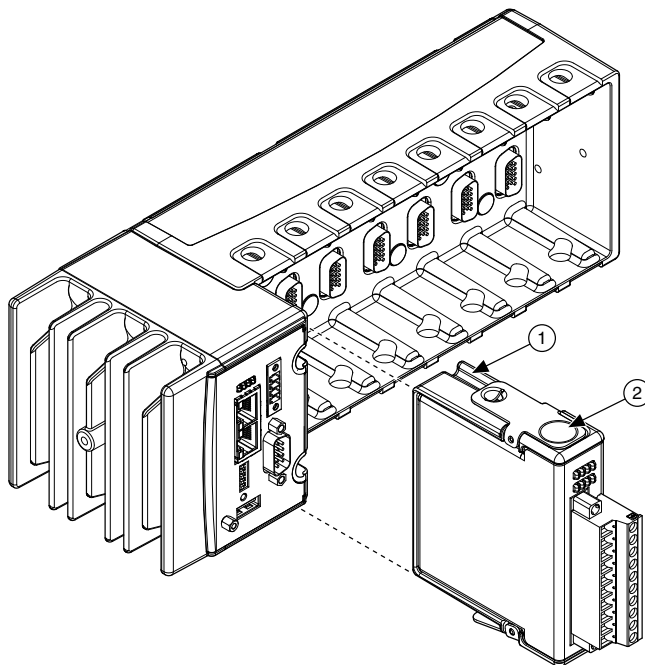

1. Insertion Groove
2. Latch

3. Squeeze the latches and insert the I/O module into the module slot.
4. Press firmly on the connector side of the I/O module until the latches lock the I/O module into place.
5. Repeat these steps to install additional I/O modules.

Removing I/O Modules from the Chassis

Complete the following steps to remove a C Series I/O module from the chassis.

1. Make sure that no I/O-side power is connected to the I/O module. If the system is in a nonhazardous location, the chassis power can be on when you remove I/O modules.
2. Squeeze the latches on both sides of the module and pull the module out of the chassis.

Connecting the Chassis to Earth Ground

You must connect the panhead screw at the end of the chassis to ground using shielded cables.

Where to Go from Here

Visit ni.com/compactrio/devguide for an overview of programming practices and examples for your CompactRIO system.

Specifications

The following specifications are typical for the range -40 °C to 70 °C unless otherwise noted. These specifications are for the reconfigurable embedded chassis only. For the controller and I/O module specifications, refer to the operating instructions for the controller and I/O modules you are using.

Reconfigurable FPGA

cRIO-9101 and cRIO-9102	
Number of logic slices	5,120
Equivalent number	11,520
Available embedded RAM	81,920 bytes
cRIO-9103 and cRIO-9104	
Number of logic slices	14,336
Equivalent number	32,256
Available embedded RAM	196,608 bytes
Timebases (40, 80, 120, 160, or 200 MHz)	
Accuracy	±100 ppm maximum
Frequency dependent jitter	
40 MHz	250 ps
80 MHz	980 ps
120 MHz	970 ps
160 MHz	960 ps
200 MHz	950 ps

Power Requirements

These power requirements are for a fully loaded chassis and exclude the power requirements of the controller and the I/O modules in the chassis. For more information about the controller

and the I/O module power requirements, refer to the controller and module documentation on ni.com/manuals.

Chassis power consumption/dissipation	
cRIO-9101 and cRIO-9102	
+5 VDC	500 mW maximum
+3.3 VDC	1,800 mW maximum
Total chassis power consumption	2,300 mW maximum
cRIO-9103 and cRIO-9104	
+5 VDC	500 mW maximum
+3.3 VDC	2,500 mW maximum
Total chassis power consumption	3,000 mW maximum



Note The power consumption specifications in this document are maximum values for a LabVIEW FPGA application compiled at 40 MHz. Visit ni.com/info and enter the Info Code `rdcriotemp` for more information about the cRIO-910x power consumption and to help you understand your application power requirements.

Physical Characteristics

If you need to clean the chassis, wipe it with a dry towel.

Weight

cRIO-9101 and cRIO-9103	Approx. 490 g (17.3 oz)
cRIO-9102 and cRIO-9104	Approx. 790 g (28 oz)

Environmental

Operating temperature (IEC 60068-2-1, IEC 60068-2-2)	-40 °C to 70 °C
---	-----------------



Caution For some applications, the operating temperature for the cRIO-910x is derated. Visit ni.com/info and enter the Info Code `rdcriotemp` for more information about the cRIO-910x operating temperature and mounting specifications.

Storage temperature (IEC 60068-2-1, IEC 60068-2-2)	-40 °C to 85 °C
Ingress protection	IP40
Operating humidity (IEC 60068-2-78)	10% RH to 90% RH, noncondensing
Storage humidity (IEC 60068-2-78)	5% RH to 95% RH, noncondensing

Pollution Degree (IEC 60664)	2
Maximum altitude	5,000 m

Indoor use only.

Shock and Vibration

To meet these specifications, you must panel mount the CompactRIO system and affix ferrules to the ends of the terminal lines.

Operating vibration	
Random (IEC 60068-2-64)	5 g _{rms} , 10 Hz to 500 Hz
Sinusoidal (IEC 60068-2-6)	5 g, 10 Hz to 500 Hz
Operating shock (IEC 60068-2-27)	30 g, 11 ms half sine; 50 g, 3 ms half sine; 18 shocks at 6 orientations

Hazardous Locations

U.S. (UL)	Class I, Division 2, Groups A, B, C, D, T4; Class I, Zone 2, AEx nA IIC T4
Canada (C-UL)	Class I, Division 2, Groups A, B, C, D, T4; Class I, Zone 2, Ex nA IIC T4
Europe (ATEX) and International (IECEX)	Ex nA IIC T4 Gc

Safety and Hazardous Locations Standards

This product is designed to meet the requirements of the following electrical equipment safety standards for measurement, control, and laboratory use:

- IEC 61010-1, EN 61010-1
- UL 61010-1, CSA 61010-1
- EN 60079-0:2012, EN 60079-15:2010
- IEC 60079-0: Ed 6, IEC 60079-15; Ed 4
- UL 60079-0; Ed 5, UL 60079-15; Ed 3
- CSA 60079-0:2011, CSA 60079-15:2012



Note For UL and other safety certifications, refer to the product label or the [Online Product Certification](#) section.

Electromagnetic Compatibility

Emissions	EN 55011 Class A at 10 m FCC Part 15A above 1 GHz
Immunity	Industrial levels per EN 61326-1:1997 + A2:2001, Table A.1
EMC/EMI	CE, C-Tick, and FCC Part 15 (Class A) Compliant



Note For EMC compliance, you must operate this device with shielded cabling. The device must be connected to earth ground.

Related Information

[Connecting the Chassis to Earth Ground](#) on page 11

CE Compliance

This product meets the essential requirements of applicable European Directives, as follows:

- 2014/35/EU; Low-Voltage Directive (safety)
- 2014/30/EU; Electromagnetic Compatibility Directive (EMC)
- 94/9/EC; Potentially Explosive Atmospheres (ATEX)

Online Product Certification

Refer to the product Declaration of Conformity (DoC) for additional regulatory compliance information. To obtain product certifications and the DoC for this product, visit ni.com/certification, search by model number or product line, and click the appropriate link in the Certification column.

Environmental Management

NI is committed to designing and manufacturing products in an environmentally responsible manner. NI recognizes that eliminating certain hazardous substances from our products is beneficial to the environment and to NI customers.

For additional environmental information, refer to the *Minimize Our Environmental Impact* web page at ni.com/environment. This page contains the environmental regulations and directives with which NI complies, as well as other environmental information not included in this document.

Waste Electrical and Electronic Equipment (WEEE)



EU Customers At the end of the product life cycle, all NI products must be disposed of according to local laws and regulations. For more information about how to recycle NI products in your region, visit ni.com/environment/weee.

Worldwide Support and Services

The NI website is your complete resource for technical support. At ni.com/support, you have access to everything from troubleshooting and application development self-help resources to email and phone assistance from NI Application Engineers.

Visit ni.com/services for NI Factory Installation Services, repairs, extended warranty, and other services.

Visit ni.com/register to register your NI product. Product registration facilitates technical support and ensures that you receive important information updates from NI.

A Declaration of Conformity (DoC) is our claim of compliance with the Council of the European Communities using the manufacturer's declaration of conformity. This system affords the user protection for electromagnetic compatibility (EMC) and product safety. You can obtain the DoC for your product by visiting ni.com/certification. If your product supports calibration, you can obtain the calibration certificate for your product at ni.com/calibration.

NI corporate headquarters is located at 11500 North Mopac Expressway, Austin, Texas, 78759-3504. NI also has offices located around the world. For telephone support in the United States, create your service request at ni.com/support or dial 1 866 ASK MYNI (275 6964). For telephone support outside the United States, visit the *Worldwide Offices* section of ni.com/niglobal to access the branch office websites, which provide up-to-date contact information, support phone numbers, email addresses, and current events.

Refer to the *NI Trademarks and Logo Guidelines* at ni.com/trademarks for information on NI trademarks. Other product and company names mentioned herein are trademarks or trade names of their respective companies. For patents covering NI products/technology, refer to the appropriate location: **Help»Patents** in your software, the `patents.txt` file on your media, or the *National Instruments Patent Notice* at ni.com/patents. You can find information about end-user license agreements (EULAs) and third-party legal notices in the readme file for your NI product. Refer to the *Export Compliance Information* at ni.com/legal/export-compliance for the NI global trade compliance policy and how to obtain relevant HTS codes, ECCNs, and other import/export data. NI MAKES NO EXPRESS OR IMPLIED WARRANTIES AS TO THE ACCURACY OF THE INFORMATION CONTAINED HEREIN AND SHALL NOT BE LIABLE FOR ANY ERRORS. U.S. Government Customers: The data contained in this manual was developed at private expense and is subject to the applicable limited rights and restricted data rights as set forth in FAR 52.227-14, DFAR 252.227-7014, and DFAR 252.227-7015.

© 2004—2015 National Instruments. All rights reserved.

371559C-01 Oct15