

## COMPREHENSIVE SERVICES

We offer competitive repair and calibration services, as well as easily accessible documentation and free downloadable resources.

## SELL YOUR SURPLUS

We buy new, used, decommissioned, and surplus parts from every NI series. We work out the best solution to suit your individual needs.

 Sell For Cash    Get Credit    Receive a Trade-In Deal

## OBSOLETE NI HARDWARE IN STOCK & READY TO SHIP

We stock **New**, **New Surplus**, **Refurbished**, and **Reconditioned** NI Hardware.



*Bridging the gap between the manufacturer and your legacy test system.*

 1-800-915-6216

 [www.apexwaves.com](http://www.apexwaves.com)

 [sales@apexwaves.com](mailto:sales@apexwaves.com)

*All trademarks, brands, and brand names are the property of their respective owners.*

**Request a Quote**

 **CLICK HERE**

**PCI-6289**

## DEVICE SPECIFICATIONS

# NI 6289

M Series Data Acquisition: 18-Bit, 625 kS/s, 32 AI, 48 DIO, 4 AO

The following specifications are typical at 25 °C, unless otherwise noted. For more information about the NI 6289, refer to the *M Series User Manual* available at [ni.com/manuals](http://ni.com/manuals).

## Analog Input

Number of channels	16 differential or 32 single ended
ADC resolution	18 bits
DNL	No missing codes guaranteed
INL	Refer to the <i>AI Absolute Accuracy</i> section
Sample rate	
Single channel maximum	625 kS/s
Multichannel maximum (aggregate)	500 kS/s
Minimum	No minimum
Timing accuracy	50 ppm of sample rate
Timing resolution	50 ns
Input coupling	DC
Input range	$\pm 0.1$ V, $\pm 0.2$ V, $\pm 0.5$ V, $\pm 1$ V, $\pm 2$ V, $\pm 5$ V, $\pm 10$ V
Maximum working voltage for analog inputs (signal + common mode)	$\pm 11$ V of AI GND
CMRR (DC to 60 Hz)	110 dB
Input impedance	
Device on	
AI+ to AI GND	$>10$ G $\Omega$ in parallel with 100 pF
AI- to AI GND	$>10$ G $\Omega$ in parallel with 100 pF

Device off	
AI+ to AI GND	820 $\Omega$
AI- to AI GND	820 $\Omega$
Input bias current	$\pm 100$ pA
Crosstalk (at 100 kHz)	
Adjacent channels	-75 dB
Non-adjacent channels	-95 dB
Small signal bandwidth (-3 dB)	750 kHz filter off, 40 kHz filter on
Input FIFO size	2,047 samples
Scan list memory	4,095 entries
Data transfers	
PCI/PXI	DMA (scatter-gather), interrupts, programmed I/O
USB	USB Signal Stream, programmed I/O
Overvoltage protection for all analog input and sense channels	
Device on	$\pm 25$ V for up to eight AI pins
Device off	$\pm 15$ V for up to eight AI pins
Input current during overvoltage condition	$\pm 20$ mA maximum/AI pin

**Table 1.** Settling Time for Multichannel Measurements

Range	Filter Off $\pm 15$ ppm of Step ( $\pm 4$ LSB for Full-Scale Step)	Filter Off $\pm 4$ ppm of Step ( $\pm 1$ LSB for Full-Scale Step)	Filter On $\pm 4$ ppm of Step ( $\pm 1$ LSB for Full-Scale Step)
$\pm 5$ V, $\pm 10$ V	2 $\mu$ s	8 $\mu$ s	50 $\mu$ s
$\pm 0.5$ V, $\pm 1$ V, $\pm 2$ V	2.5 $\mu$ s	8 $\mu$ s	50 $\mu$ s
$\pm 0.1$ V, $\pm 0.2$ V	3 $\mu$ s	8 $\mu$ s	50 $\mu$ s

# Typical Performance Graphs

**Figure 1.** AI Settling Error versus Time for Different Source Impedances

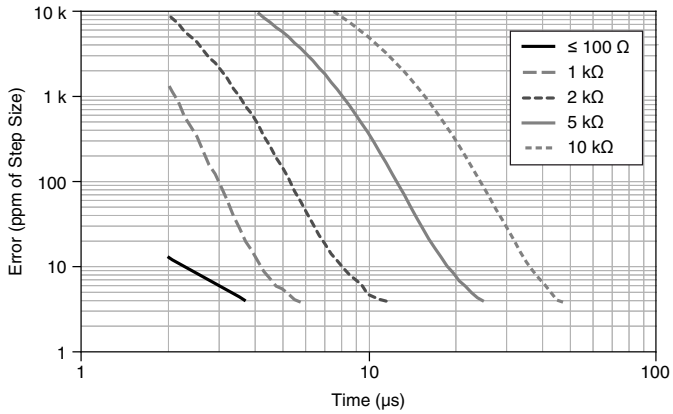

**Figure 2.** AI Small Signal Bandwidth

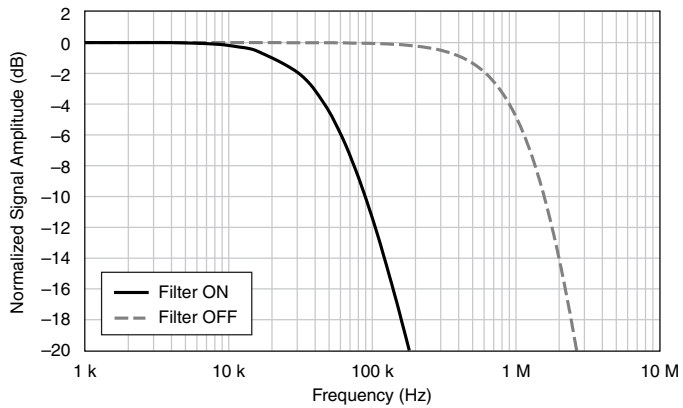

**Figure 3. AI CMRR**

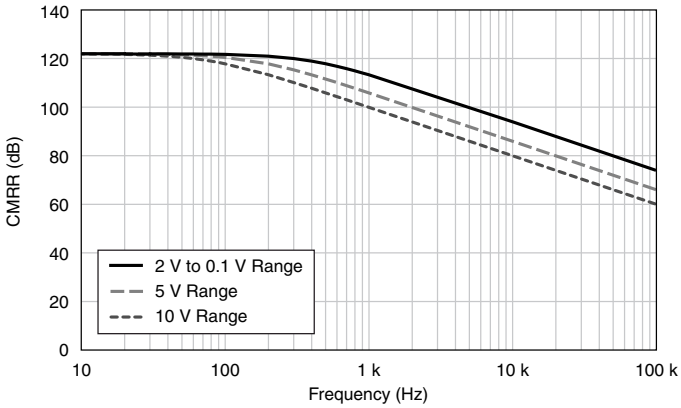

## AI Absolute Accuracy

### AI Absolute Accuracy (Filter On)



**Note** Accuracies listed are valid for up to two years from the device external calibration.

**Table 2. AI Absolute Accuracy (Filter On)**

Nominal Range Positive Full Scale	Nominal Range Negative Full Scale	Residual Gain Error (ppm of Reading)	Residual Offset Error (ppm of Range)	Offset Tempco (ppm of Range/°C)	Random Noise, $\sigma$ ( $\mu$ Vrms)	Absolute Accuracy at Full Scale ( $\mu$ V)	Sensitivity ( $\mu$ V)
10	-10	40	8	11	60	980	24
5	-5	45	8	11	30	510	12
2	-2	45	8	13	12	210	4.8
1	-1	55	15	15	7	120	2.8
0.5	-0.5	55	30	20	4	70	1.6
0.2	-0.2	75	45	35	3	39	1.2
0.1	-0.1	120	60	60	2	28	0.8



**Note** Sensitivity is the smallest voltage change that can be detected. It is a function of noise.

Gain tempco	17 ppm/°C
Reference tempco	1 ppm/°C
INL error	10 ppm of range

## AI Absolute Accuracy (Filter Off)



**Note** Accuracies listed are valid for up to two years from the device external calibration.

**Table 3.** AI Absolute Accuracy (Filter Off)

Nominal Range Positive Full Scale	Nominal Range Negative Full Scale	Residual Gain Error (ppm of Reading)	Residual Offset Error (ppm of Range)	Offset Tempco (ppm of Range/°C)	Random Noise, $\sigma$ ( $\mu$ Vrms)	Absolute Accuracy at Full Scale ( $\mu$ V)	Sensitivity ( $\mu$ V)
10	-10	45	10	11	70	1,050	28.0
5	-5	50	10	11	35	550	14.0
2	-2	50	10	13	15	230	6.0
1	-1	60	17	15	12	130	4.8
0.5	-0.5	60	32	20	10	80	4.0
0.2	-0.2	80	47	35	9	43	3.6
0.1	-0.1	120	62	60	9	31	3.6



**Note** Sensitivity is the smallest voltage change that can be detected. It is a function of noise.

Gain tempco	17 ppm/°C
Reference tempco	1 ppm/°C
INL error	10 ppm of range

## AI Absolute Accuracy Equation

$$\text{AbsoluteAccuracy} = \text{Reading} \cdot (\text{GainError}) + \text{Range} \cdot (\text{OffsetError}) + \text{NoiseUncertainty}$$

$$\text{GainError} = \text{ResidualAIGainError} + \text{GainTempco} \cdot (\text{TempChangeFromLastInternalCal}) + \text{ReferenceTempco} \cdot (\text{TempChangeFromLastExternalCal})$$

$$\text{OffsetError} = \text{ResidualAIOffsetError} + \text{OffsetTempco} \cdot (\text{TempChangeFromLastInternalCal}) + \text{INLError}$$

$$\text{NoiseUncertainty} = \frac{\text{Random Noise} \cdot 3}{\sqrt{100}} \text{ for a coverage factor of } 3 \sigma \text{ and averaging}$$

100 points.

## AI Absolute Accuracy Example

Absolute accuracy at full scale on the analog input channels is determined using the following assumptions:

- TempChangeFromLastExternalCal = 10 °C
- TempChangeFromLastInternalCal = 1 °C
- number\_of\_readings = 100
- CoverageFactor = 3  $\sigma$

For example, on the 10 V range of the Filter On accuracy table, the absolute accuracy at full scale is as follows:

$$\text{GainError} = 40 \text{ ppm} + 17 \text{ ppm} \cdot 1 + 1 \text{ ppm} \cdot 10 = 67 \text{ ppm}$$

$$\text{OffsetError} = 8 \text{ ppm} + 11 \text{ ppm} \cdot 1 + 10 \text{ ppm} = 29 \text{ ppm}$$

$$\text{NoiseUncertainty} = \frac{60 \mu\text{V} \cdot 3}{\sqrt{100}} = 18 \mu\text{V}$$

$$\text{AbsoluteAccuracy} = 10 \text{ V} \cdot (\text{GainError}) + 10 \text{ V} \cdot (\text{OffsetError}) + \text{NoiseUncertainty} = 980 \mu\text{V}$$

## Analog Triggers

Number of triggers	1
Source	AI <0..31>, APFI <0, 1>
Functions	Start Trigger, Reference Trigger, Pause Trigger, Sample Clock, Convert Clock, Sample Clock Timebase
Source level	
AI <0..31>	±Full scale
APFI <0, 1>	±10 V
Resolution	10 bits, 1 in 1,024
Modes	Analog edge triggering, analog edge triggering with hysteresis, and analog window triggering
Bandwidth (-3 dB)	
AI <0..31>	700 kHz filter off, 40 kHz filter on
APFI <0, 1>	5 MHz
Accuracy	±1%

## APFI <0, 1> characteristics

Input impedance	10 k $\Omega$
Coupling	DC
Protection, power on	$\pm 30$ V
Protection, power off	$\pm 15$ V

## Analog Output

Number of channels	4
DAC resolution	16 bits
DNL	$\pm 1$ LSB
Monotonicity	16 bit guaranteed
Accuracy	Refer to the <i>AO Absolute Accuracy</i> section
Maximum update rate	
1 channel	2.86 MS/s
2 channels	2.00 MS/s per channel
3 channels	1.54 MS/s per channel
4 channels	1.25 MS/s per channel
Timing accuracy	50 ppm of sample rate
Timing resolution	50 ns
Output range (offset $\pm$ reference)	
Calibrated ranges	$\pm 1$ V, $\pm 2$ V, $\pm 5$ V, $\pm 10$ V
Offset sources	0 V, 5 V, APFI <0, 1>, AO <0..3> <sup>1</sup>
Reference sources	1 V, 2 V, 5 V, 10 V, APFI <0, 1>, AO <0..3> <sup>2</sup>
Maximum output level	$\pm 11$ V
Output coupling	DC
Output impedance	0.2 $\Omega$
Output current drive	$\pm 5$ mA
Overdrive protection	$\pm 25$ V
Overdrive current	20 mA

<sup>1</sup> An AO channel cannot be a reference or offset to itself.

<sup>2</sup> When the USB Screw Terminal device is powered on, the analog output signal is not defined until after the USB configuration is complete.



Power-on state <sup>3</sup>	±5 mV
Power-on glitch	2.3 V peak for 1.2 s
Output FIFO size	8,191 samples shared among channels used
Data transfers	
PCI/PXI	DMA (scatter-gather), interrupts, programmed I/O
USB	USB Signal Stream, programmed I/O
AO waveform modes	Non-periodic waveform, periodic waveform regeneration mode from onboard FIFO, periodic waveform regeneration from host buffer including dynamic update
Settling time, full-scale step, 15 ppm (1 LSB)	3 μs
Slew rate	20 V/μs
Glitch energy at midscale transition, ±10 V range	
Magnitude	15 mV
Duration	0.5 μs

## External Reference

### APFI <0,1> characteristics

Input impedance	10 kΩ
Coupling	DC
Protection, device on	±30 V
Protection, device off	±15 V
Range	±11 V

<sup>3</sup> For all USB Screw Terminal devices, when powered on, the analog output signal is not defined until after USB configuration is complete.

**Figure 4. AO External Reference Bandwidth**

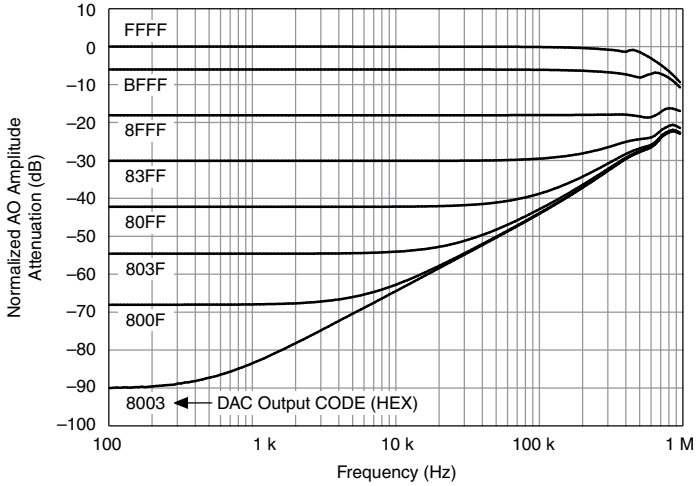

## AO Absolute Accuracy

Absolute accuracy at full-scale numbers is valid immediately following internal calibration and assumes the device is operating within 10 °C of the last external calibration.



**Note** Accuracies listed are valid for up to two years from the device external calibration.

**Table 4. AO Absolute Accuracy**

Nominal Range Positive Full Scale	Nominal Range Negative Full Scale	Residual Gain Error (ppm of Reading)	Gain Tempco (ppm/°C)	Residual Offset Error (ppm of Range)	Offset Tempco (ppm of Range/°C)	Absolute Accuracy at Full Scale (µV)
10	-10	55	15	30	12	1,540
5	-5	60	15	30	17	820
2	-2	65	25	40	30	404
1	-1	85	25	57	50	259

Reference tempco 1 ppm/°C

INL error 32 ppm of range

## AO Absolute Accuracy Equation

$$\text{AbsoluteAccuracy} = \text{OutputValue} \cdot (\text{GainError}) + \text{Range} \cdot (\text{OffsetError})$$

$$\text{GainError} = \text{ResidualGainError} + \text{GainTempco} \cdot (\text{TempChangeFromLastInternalCal}) + \text{ReferenceTempco} \cdot (\text{TempChangeFromLastExternalCal})$$

$$\text{OffsetError} = \text{ResidualOffsetError} + \text{AOOffsetTempco} \cdot (\text{TempChangeFromLastInternalCal}) + \text{INLError}$$

## Digital I/O/PFI

---

### Static Characteristics

Number of channels	48 total, 32 (P0.<0..31>), 16 (PFI <0..7>/P1, PFI <8..15>/P2)
I/O type	5 V TTL/CMOS compatible
Ground reference	D GND
Direction control	Each terminal individually programmable as input or output
Pull-down resistor	50 k $\Omega$ typical, 20 k $\Omega$ minimum
Input voltage protection	$\pm 20$ V on up to two pins <sup>4</sup>

### Waveform Characteristics (Port 0 Only)

Terminals used	Port 0 (P0.<0..31>)
Port/sample size	Up to 32 bits
Waveform generation (DO) FIFO	2,047 samples
Waveform acquisition (DI) FIFO	2,047 samples
DI Sample Clock frequency	
PCI/PXI	0 MHz to 10 MHz, system and bus activity dependent
USB	0 MHz to 1 MHz, system and bus activity dependent

---

<sup>4</sup> Stresses beyond those listed under *Input voltage protection* may cause permanent damage to the device.

## DO Sample Clock frequency

PCI/PXI	
Regenerate from FIFO	0 MHz to 10 MHz
Streaming from memory	0 MHz to 10 MHz, system and bus activity dependent
USB	
Regenerate from FIFO	0 MHz to 10 MHz
Streaming from memory	0 MHz to 1 MHz, system and bus activity dependent
Data transfers	
PCI/PXI	DMA (scatter-gather), interrupts, programmed I/O
USB	USB Signal Stream, programmed I/O
DI or DO Sample Clock source <sup>5</sup>	Any PFI, RTSI, AI Sample or Convert Clock, AO Sample Clock, Ctr <i>n</i> Internal Output, and many other signals

## PFI/Port 1/Port 2 Functionality

Functionality	Static digital input, static digital output, timing input, timing output
Timing output sources	Many AI, AO, counter, DI, DO timing signals
Debounce filter settings	125 ns, 6.425 $\mu$ s, 2.56 ms, disable; high and low transitions; selectable per input

## Recommended Operating Conditions

Level	Minimum	Maximum
Input high voltage ( $V_{IH}$ )	2.2 V	5.25 V
Input low voltage ( $V_{IL}$ )	0 V	0.8 V
Output high current ( $I_{OH}$ ) P0.<0..31>	—	-24 mA
Output high current ( $I_{OH}$ ) PFI <0..15>/P1/P2	—	-16 mA
Output low current ( $I_{OL}$ ) P0.<0..31>	—	24 mA
Output low current ( $I_{OL}$ ) PFI <0..15>/P1/P2	—	16 mA

<sup>5</sup> The digital subsystem does not have its own dedicated internal timing engine. Therefore, a sample clock must be provided from another subsystem on the device or an external source.

# Electrical Characteristics

Level	Minimum	Maximum
Positive-going threshold (VT+)	—	2.2 V
Negative-going threshold (VT-)	0.8 V	—
Delta VT hysteresis (VT+ - VT-)	0.2 V	—
I <sub>IL</sub> input low current (V <sub>in</sub> = 0 V)	—	-10 μA
I <sub>IH</sub> input high current (V <sub>in</sub> = 5 V)	—	250 μA

# Digital I/O Characteristics

**Figure 5.** Digital I/O (P0.<0..31>): I<sub>oh</sub> versus V<sub>oh</sub>

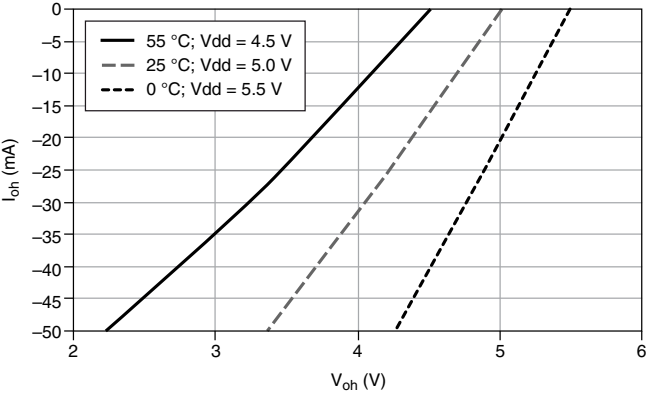

**Figure 6.** Digital I/O (PFI <0..15>/P1/P2):  $I_{oh}$  versus  $V_{oh}$

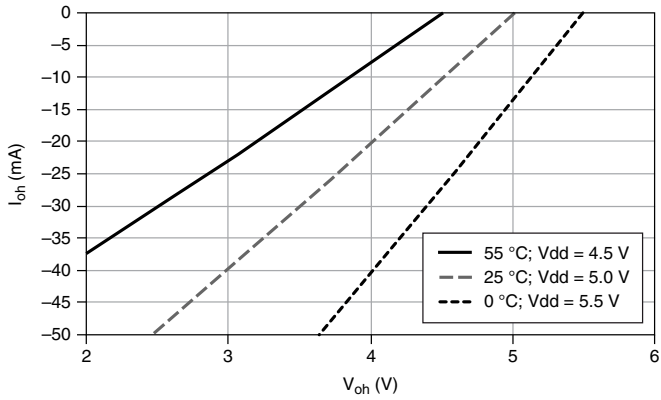

**Figure 7.** Digital I/O (P0.<0..31>):  $I_{ol}$  versus  $V_{ol}$

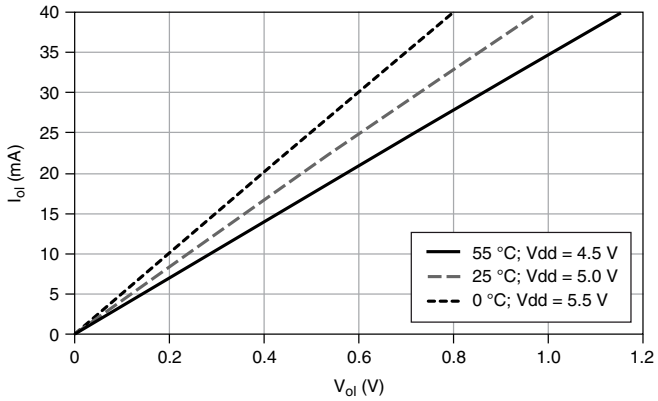

**Figure 8.** Digital I/O (PFI <0..15>/P1/P2):  $I_{OI}$  versus  $V_{OI}$

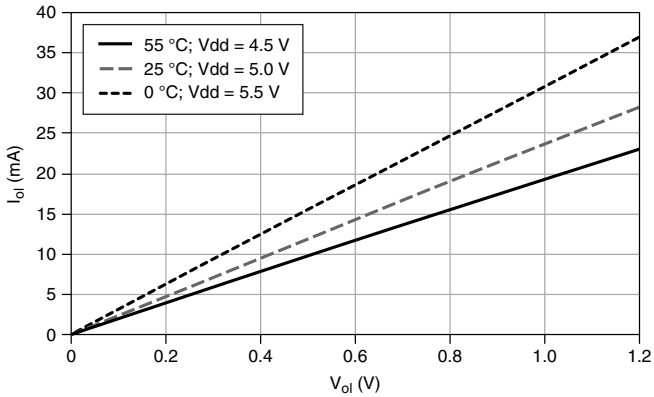

## General-Purpose Counters/Timers

Number of counter/timers	2
Resolution	32 bits
Counter measurements	Edge counting, pulse, semi-period, period, two-edge separation
Position measurements	X1, X2, X4 quadrature encoding with Channel Z reloading; two-pulse encoding
Output applications	Pulse, pulse train with dynamic updates, frequency division, equivalent time sampling
Internal base clocks	80 MHz, 20 MHz, 0.1 MHz
External base clock frequency	0 MHz to 20 MHz
Base clock accuracy	50 ppm
Inputs	Gate, Source, HW_Arm, Aux, A, B, Z, Up_Down
Routing options for inputs	Any PFI, RTSI, PXI_TRIG, PXI_STAR, analog trigger, many internal signals
FIFO	2 samples
Data transfers	
PCI/PXI	Dedicated scatter-gather DMA controller for each counter/timer; interrupts, programmed I/O
USB	USB Signal Stream, programmed I/O

# Frequency Generator

---

Number of channels	1
Base clocks	10 MHz, 100 kHz
Divisors	1 to 16
Base clock accuracy	50 ppm

Output can be available on any output PFI or RTSI terminal.

# Phase-Locked Loop (PLL)

---



**Note** PCI/PXI devices only.

Number of PLLs	1
Reference signal	PXI_STAR, PXI_CLK10, RTSI <0..7>
Output of PLL	80 MHz Timebase; other signals derived from 80 MHz Timebase including 20 MHz and 100 kHz Timebases

# External Digital Triggers

---

Source	Any PFI, RTSI, PXI_TRIG, PXI_STAR
Polarity	Software-selectable for most signals
Analog input function	Start Trigger, Reference Trigger, Pause Trigger, Sample Clock, Convert Clock, Sample Clock Timebase
Analog output function	Start Trigger, Pause Trigger, Sample Clock, Sample Clock Timebase
Counter/timer function	Gate, Source, HW_Arm, Aux, A, B, Z, Up_Down
Digital waveform generation (DO) function	Sample Clock
Digital waveform acquisition (DI) function	Sample Clock



## Device-to-Device Trigger Bus

PCI	RTSI <0..7> <sup>6</sup>
PXI	PXI_TRIG <0..7>, PXI_STAR
USB source	None
Output selections	10 MHz Clock, frequency generator output, many internal signals
Debounce filter settings	125 ns, 6.425 μs, 2.56 ms, disable; high and low transitions; selectable per input

## Bus Interface

PCI/PXI	3.3 V or 5 V signal environment
USB	USB 2.0 Hi-Speed or full-speed <sup>7, 8</sup>
DMA channels (PCI/PXI)	6, can be used for analog input, analog output, digital input, digital output, counter/timer 0, counter/timer 1
USB Signal Stream	4, can be used for analog input, analog output, digital input, digital output, counter/timer 0, counter/timer 1

The PXI device supports one of the following features:

- May be installed in PXI Express hybrid slots
- Or, may be used to control SCXI in PXI/SCXI combo chassis

**Table 5.** PXI/SCXI Combo and PXI Express Chassis Compatibility

<b>M Series Part Number</b>	<b>SCXI Control in PXI/SCXI Combo Chassis</b>	<b>PXI Express Hybrid Slot Compatible</b>
191501C-01	No	Yes
191501C-11	Yes	No
191501A-0x/191501B-0x	Yes	No

<sup>6</sup> In other sections of this document, RTSI refers to RTSI <0..7> for the PCI devices or PXI\_TRIG <0..7> for PXI devices.

<sup>7</sup> If you are using a USB M Series device in full-speed mode, device performance will be lower and you will not be able to achieve maximum sample/update rates.

<sup>8</sup> Operating on a full-speed bus may result in lower performance.

# Power Requirements

---

## PCI/PXI

Current draw from bus during no-load condition<sup>9</sup>

+5 V	0.03 A
------	--------

+3.3 V	0.78 A
--------	--------

+12 V	0.40 A
-------	--------

-12 V	0.06 A
-------	--------

Current draw from bus during AI and AO overvoltage condition<sup>9</sup>

+5 V	0.03 A
------	--------

+3.3 V	1.26 A
--------	--------

+12 V	0.43 A
-------	--------

-12 V	0.06 A
-------	--------



**Caution** USB devices must be powered with an NI offered AC adapter or a National Electric Code (NEC) Class 2 DC source that meets the power requirements for the device and has appropriate safety certification marks for country of use.

## USB

Power supply requirements	11 to 30 VDC, 20 W, locking or non-locking power jack with 0.080 in. diameter center pin, 5/16-32 thread for locking collars
---------------------------	--

Power supply fuse	2 A, 250 V
-------------------	------------

# Current Limits

---



**Caution** Exceeding the current limits may cause unpredictable behavior by the device and/or PC/chassis.

## PCI

+5 V terminal (connector 0)	1 A maximum <sup>10</sup>
-----------------------------	---------------------------

+5 V terminal (connector 1)	1 A maximum <sup>10</sup>
-----------------------------	---------------------------

---

<sup>9</sup> Does not include P0/PFI/P1/P2 and +5 V terminals.

<sup>10</sup> Older revisions have a self-resetting fuse that opens when current exceeds this specification. Newer revisions have a traditional fuse that opens when current exceeds this specification. This fuse is not customer-replaceable; if the fuse permanently opens, return the device to NI for repair.

## PXI

+5 V terminal (connector 0)	1 A maximum <sup>10</sup>
+5 V terminal (connector 1)	1 A maximum <sup>10</sup>
P0/PFI/P1/P2 and +5 V terminals combined	2 A maximum

## USB

+5 V terminal	1 A maximum <sup>11</sup>
P0/PFI/P1/P2 and +5 V terminals combined	2 A maximum

# Physical Characteristics

## Dimensions

PCI printed circuit board	10.6 cm × 15.5 cm (4.2 in. × 6.1 in.)
PXI printed circuit board	Standard 3U PXI
USB Mass Termination enclosure (includes connectors)	18.8 cm × 17.09 cm × 4.45 cm (7.4 in. × 6.73 in. × 1.75 in.)
USB Screw Terminal enclosure (includes connectors)	26.67 cm × 17.09 cm × 4.45 cm (10.5 in. × 6.73 in. × 1.75 in.)
USB OEM	Refer to the <i>NI USB-622x/625x/628x OEM User Guide</i>

## Weight

PCI	167 g (5.9 oz)
PXI	237 g (8.4 oz)
USB Mass Termination	1.06 kg (2 lb 5.5 oz)
USB Screw Terminal	1.52 kg (3 lb 5.5 oz)
USB OEM	274 g (9.6 oz)

## I/O connectors

PCI/PXI	2 68-pin VHDCI
USB Mass Termination	2 68-pin SCSI
USB Screw Terminal	128 screw terminals
USB OEM	2 34-pin IDC, 2 50-pin IDC

Screw terminal wiring	16 to 28 AWG
-----------------------	--------------

<sup>11</sup> Has a user-replaceable socketed fuse that opens when current exceeds this specification. Refer to the *M Series User Manual* for information about fuse replacement.

# Calibration

---

## Recommended warm-up time

PCI/PXI/PCI Express/PXI Express	15 minutes
USB	30 minutes
Calibration interval	2 years

# Maximum Working Voltage

---

*Maximum working voltage* refers to the signal voltage plus the common-mode voltage.

Channel-to-earth 11 V, Measurement Category I

---

Measurement Category I is for measurements performed on circuits not directly connected to the electrical distribution system referred to as MAINS voltage. MAINS is a hazardous live electrical supply system that powers equipment. This category is for measurements of voltages from specially protected secondary circuits. Such voltage measurements include signal levels, special equipment, limited-energy parts of equipment, circuits powered by regulated low-voltage sources, and electronics.



**Caution** Do not use for measurements within Categories II, III, or IV.



**Note** Measurement Categories CAT I and CAT O (Other) are equivalent. These test and measurement circuits are not intended for direct connection to the MAINS building installations of Measurement Categories CAT II, CAT III, or CAT IV.

# Environmental

---

## Operating temperature

PCI/PXI	0 °C to 55 °C
USB	0 °C to 45 °C
Storage temperature	-20 °C to 70 °C
Humidity	10% RH to 90% RH, noncondensing
Maximum altitude	2,000 m
Pollution Degree (indoor use only)	2

Indoor use only.

## Shock and Vibration (PXI Only)

---

Operational shock	30 g peak, half-sine, 11 ms pulse (Tested in accordance with IEC 60068-2-27. Test profile developed in accordance with MIL-PRF-28800F.)
Random vibration	
Operating	5 Hz to 500 Hz, 0.3 g <sub>rms</sub>
Nonoperating	5 Hz to 500 Hz, 2.4 g <sub>rms</sub> (Tested in accordance with IEC 60068-2-64. Nonoperating test profile exceeds the requirements of MIL-PRF-28800F, Class 3.)

## Safety

---

This product is designed to meet the requirements of the following electrical equipment safety standards for measurement, control, and laboratory use:

- IEC 61010-1, EN 61010-1
- UL 61010-1, CSA 61010-1



**Note** For UL and other safety certifications, refer to the product label or the [Online Product Certification](#) section.

## Electromagnetic Compatibility

---

This product meets the requirements of the following EMC standards for electrical equipment for measurement, control, and laboratory use:

- EN 61326-1 (IEC 61326-1): Class A emissions; Basic immunity
- EN 55011 (CISPR 11): Group 1, Class A emissions
- EN 55022 (CISPR 22): Class A emissions
- EN 55024 (CISPR 24): Immunity
- AS/NZS CISPR 11: Group 1, Class A emissions
- AS/NZS CISPR 22: Class A emissions
- FCC 47 CFR Part 15B: Class A emissions
- ICES-001: Class A emissions



**Note** In the United States (per FCC 47 CFR), Class A equipment is intended for use in commercial, light-industrial, and heavy-industrial locations. In Europe, Canada, Australia and New Zealand (per CISPR 11) Class A equipment is intended for use only in heavy-industrial locations.



**Note** Group 1 equipment (per CISPR 11) is any industrial, scientific, or medical equipment that does not intentionally generate radio frequency energy for the treatment of material or inspection/analysis purposes.



**Note** For EMC declarations and certifications, and additional information, refer to the [Online Product Certification](#) section.

## CE Compliance

---

This product meets the essential requirements of applicable European Directives, as follows:

- 2014/35/EU; Low-Voltage Directive (safety)
- 2014/30/EU; Electromagnetic Compatibility Directive (EMC)
- 2011/65/EU; Restriction of Hazardous Substances (RoHS)

## Online Product Certification

---

Refer to the product Declaration of Conformity (DoC) for additional regulatory compliance information. To obtain product certifications and the DoC for this product, visit [ni.com/certification](https://ni.com/certification), search by model number or product line, and click the appropriate link in the Certification column.

## Environmental Management

---

NI is committed to designing and manufacturing products in an environmentally responsible manner. NI recognizes that eliminating certain hazardous substances from our products is beneficial to the environment and to NI customers.

For additional environmental information, refer to the *Minimize Our Environmental Impact* web page at [ni.com/environment](https://ni.com/environment). This page contains the environmental regulations and directives with which NI complies, as well as other environmental information not included in this document.

## Waste Electrical and Electronic Equipment (WEEE)



**EU Customers** At the end of the product life cycle, all NI products must be disposed of according to local laws and regulations. For more information about how to recycle NI products in your region, visit [ni.com/environment/weee](https://ni.com/environment/weee).

## 电子信息产品污染控制管理办法（中国 RoHS）



**中国客户** National Instruments 符合中国电子信息产品中限制使用某些有害物质指令 (RoHS)。关于 National Instruments 中国 RoHS 合规性信息，请登录 [ni.com/environment/rohs\\_china](https://ni.com/environment/rohs_china)。(For information about China RoHS compliance, go to [ni.com/environment/rohs\\_china](https://ni.com/environment/rohs_china).)

# Device Pinouts

**Figure 9. NI PCI/PXI-6289 Pinout**

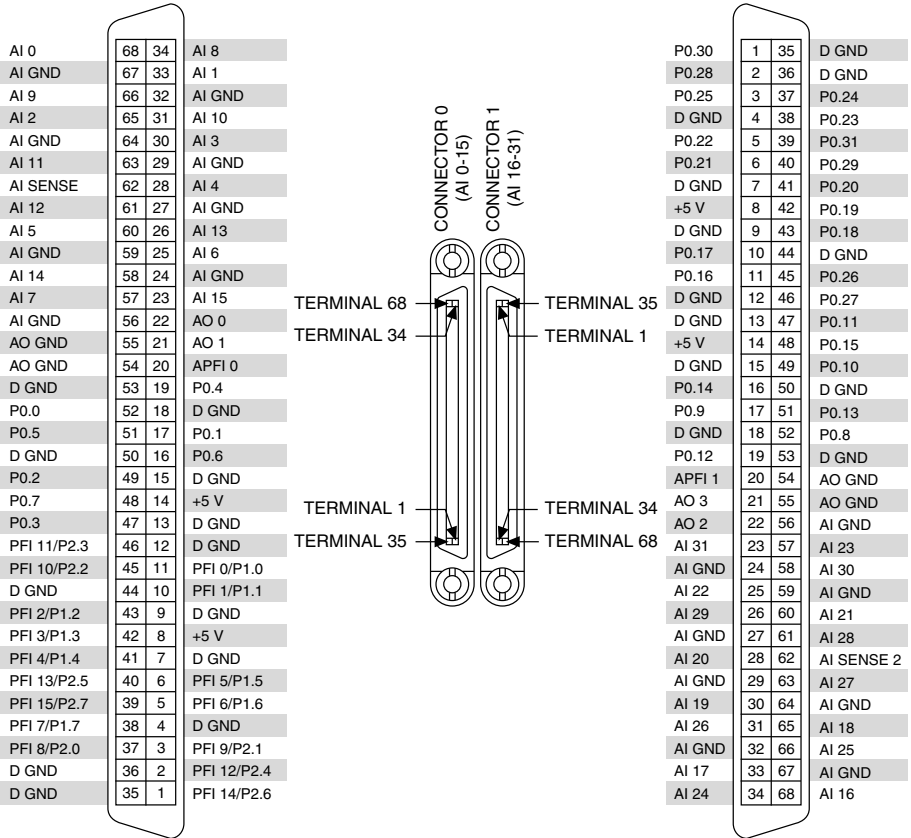

**Figure 10. NI USB-6289 Mass Termination Pinout**

AI 8	34	68	AI 0	AI 24	34	68	AI 16
AI 1	33	67	AI GND	AI 17	33	67	AI GND
AI GND	32	66	AI 9	AI GND	32	66	AI 25
AI 10	31	65	AI 2	AI 26	31	65	AI 18
AI 3	30	64	AI GND	AI 19	30	64	AI GND
AI GND	29	63	AI 11	AI GND	29	63	AI 27
AI 4	28	62	AI SENSE	AI 20	28	62	AI SENSE 2
AI GND	27	61	AI 12	AI GND	27	61	AI 28
AI 13	26	60	AI 5	AI 29	26	60	AI 21
AI 6	25	59	AI GND	AI 22	25	59	AI GND
AI GND	24	58	AI 14	AI GND	24	58	AI 30
AI 15	23	57	AI 7	AI 31	23	57	AI 23
AO 0	22	56	AI GND	AO 2	22	56	AI GND
AO 1	21	55	AO GND	AO 3	21	55	AO GND
APFI 0	20	54	AO GND	APFI 1	20	54	AO GND
P0.4	19	53	D GND	P0.12	19	53	D GND
D GND	18	52	P0.0	D GND	18	52	P0.8
P0.1	17	51	P0.5	P0.9	17	51	P0.13
P0.6	16	50	D GND	P0.14	16	50	D GND
D GND	15	49	P0.2	D GND	15	49	P0.10
+5 V	14	48	P0.7	+5 V	14	48	P0.15
D GND	13	47	P0.3	D GND	13	47	P0.11
D GND	12	46	PFI 11/P2.3	D GND	12	46	P0.27
PFI 0/P1.0	11	45	PFI 10/P2.2	P0.16	11	45	P0.26
PFI 1/P1.1	10	44	D GND	P0.17	10	44	D GND
D GND	9	43	PFI 2/P1.2	D GND	9	43	P0.18
+5 V	8	42	PFI 3/P1.3	+5 V	8	42	P0.19
D GND	7	41	PFI 4/P1.4	D GND	7	41	P0.20
PFI 5/P1.5	6	40	PFI 13/P2.5	P0.21	6	40	P0.29
PFI 6/P1.6	5	39	PFI 15/P2.7	P0.22	5	39	P0.31
D GND	4	38	PFI 7/P1.7	D GND	4	38	P0.23
PFI 9/P2.1	3	37	PFI 8/P2.0	P0.25	3	37	P0.24
PFI 12/P2.4	2	36	D GND	P0.28	2	36	D GND
PFI 14/P2.6	1	35	D GND	P0.30	1	35	D GND

**CONNECTOR 0**  
(AI 0–15)

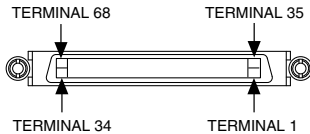

**CONNECTOR 1**  
(AI 16–31)

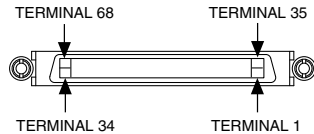



**Figure 11. NI USB-6289 Screw Terminal Pinout**

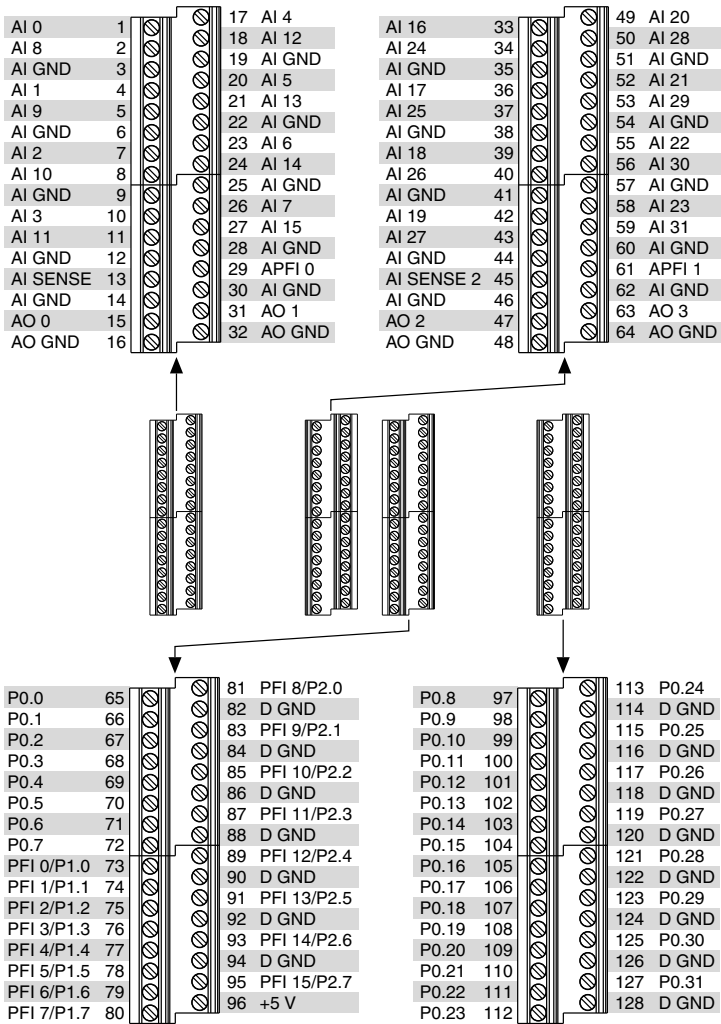

Refer to the *NI Trademarks and Logo Guidelines* at [ni.com/trademarks](http://ni.com/trademarks) for information on NI trademarks. Other product and company names mentioned herein are trademarks or trade names of their respective companies. For patents covering NI products/technology, refer to the appropriate location: **Help»Patents** in your software, the `patents.txt` file on your media, or the *National Instruments Patent Notice* at [ni.com/patents](http://ni.com/patents). You can find information about end-user license agreements (EULAs) and third-party legal notices in the readme file for your NI product. Refer to the *Export Compliance Information* at [ni.com/legal/export-compliance](http://ni.com/legal/export-compliance) for the NI global trade compliance policy and how to obtain relevant HTS codes, ECCNs, and other import/export data. NI MAKES NO EXPRESS OR IMPLIED WARRANTIES AS TO THE ACCURACY OF THE INFORMATION CONTAINED HEREIN AND SHALL NOT BE LIABLE FOR ANY ERRORS. U.S. Government Customers: The data contained in this manual was developed at private expense and is subject to the applicable limited rights and restricted data rights as set forth in FAR 52.227-14, DFAR 252.227-7014, and DFAR 252.227-7015.