

COMPREHENSIVE SERVICES

We offer competitive repair and calibration services, as well as easily accessible documentation and free downloadable resources.

SELL YOUR SURPLUS

We buy new, used, decommissioned, and surplus parts from every NI series. We work out the best solution to suit your individual needs.

 Sell For Cash  Get Credit  Receive a Trade-In Deal

OBSOLETE NI HARDWARE IN STOCK & READY TO SHIP

We stock **New**, **New Surplus**, **Refurbished**, and **Reconditioned** NI Hardware.



Bridging the gap between the manufacturer and your legacy test system.

 1-800-915-6216

 www.apexwaves.com

 sales@apexwaves.com

All trademarks, brands, and brand names are the property of their respective owners.

Request a Quote

 **CLICK HERE**

PCI-8431-8

Manufacturer: National Instruments

Board Assembly Part Numbers (Refer to Procedure 1 for identification procedure):

Part Number and Revision	Description
191883B-0xL or later	PXI-8430/8, PXI-8431/8
191889B-01L or later	PXI-8430/16
191880B-0xL or later	PCI-8430/8, PCI-8431/8
191886B-01L or later	PCI-8430/16

Volatile Memory

<i>Target Data</i>	<i>Type</i>	<i>Size</i>	<i>Battery Backup</i>	<i>User¹ Accessible</i>	<i>System Accessible</i>	<i>Sanitization Procedure</i>
None						

Non-Volatile Memory (incl. Media Storage)

<i>Target Data</i>	<i>Type</i>	<i>Size</i>	<i>Battery Backup</i>	<i>User Accessible</i>	<i>System Accessible</i>	<i>Sanitization Procedure</i>
Glue logic	CPLD (8430/8 only)	Intel EPM7064S	No	No	No	None
Glue logic	CPLD (8431/8 and 8430/16 only)	Intel EPM7128S	No	No	No	None
Device configuration	EEPROM	64 Kbit	No	No	Yes	None

¹ Refer to *Terms and Definitions* section for clarification of *User* and *System Accessible*

Procedures

Procedure 1 – Board Assembly Part Number identification:

To determine the Board Assembly Part Number and Revision, refer to the “Assy#” label applied to the surface of your product as marked by red on the drawing below. The Assembly Part Number should be formatted as “P/N: #####a-xyL” where “a” is the letter revision of the Board Assembly (eg. A, B, C...X) and the “xy” is the type definition (eg.: 01 = 8430, 8-port, 02 = 8431, 8-port).

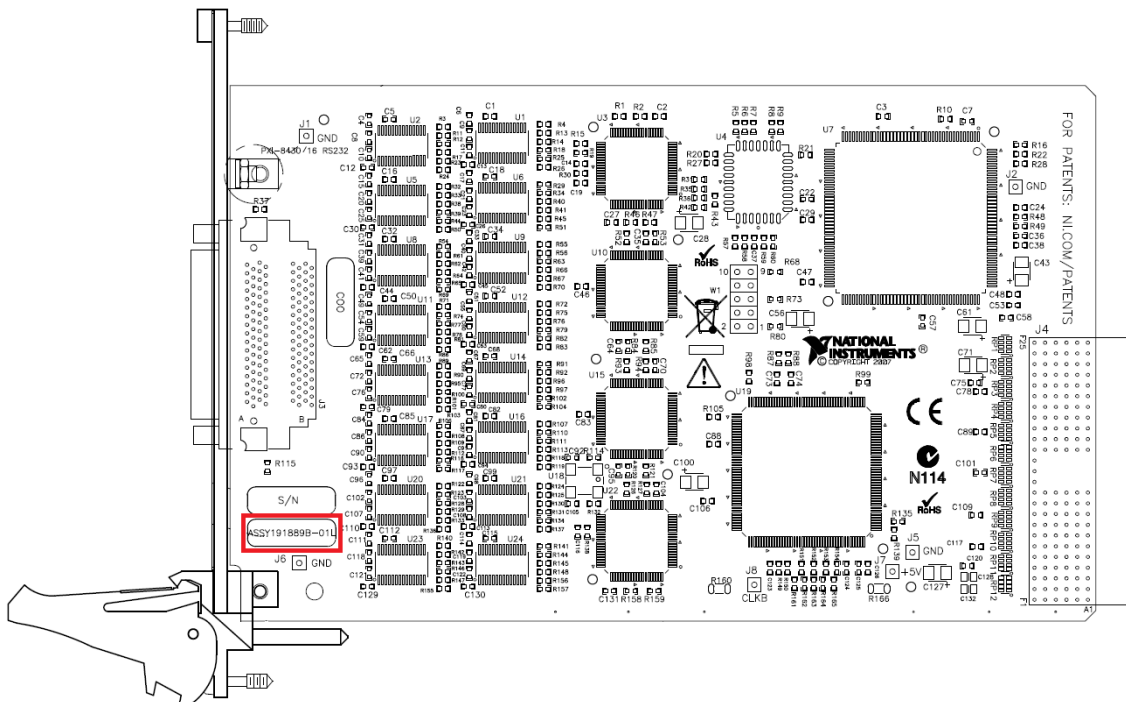
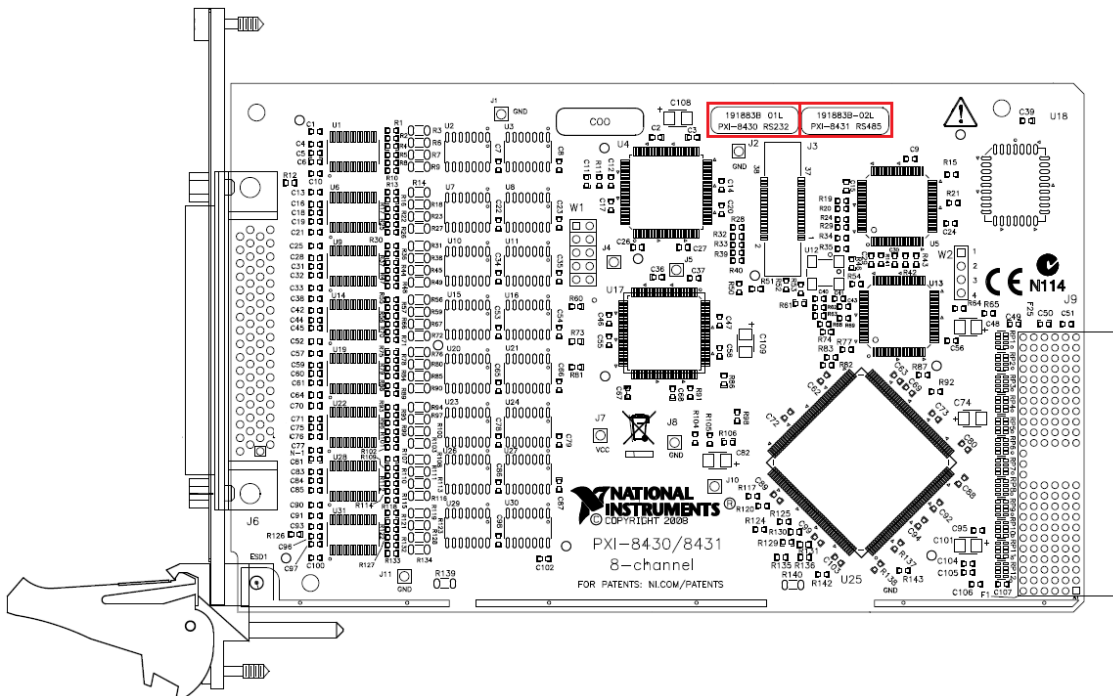

Terms and Definitions

Cycle Power:

The process of completely removing power from the device and its components and allowing for adequate discharge. This process includes a complete shutdown of the PC and/or chassis containing the device; a reboot is not sufficient for the completion of this process.

Volatile Memory:

Requires power to maintain the stored information. When power is removed from this memory, its contents are lost. This type of memory typically contains application specific data such as capture waveforms.

Non-Volatile Memory:

Power is not required to maintain the stored information. Device retains its contents when power is removed. This type of memory typically contains information necessary to boot, configure, or calibrate the product or may include device power up states.

User Accessible:

The component is read and/or write addressable such that a user can store arbitrary information to the component from the host using a publicly distributed NI tool, such as a Driver API, the System Configuration API, or MAX.

System Accessible:

The component is read and/or write addressable from the host without the need to physically alter the product.

Clearing:

Per *NIST Special Publication 800-88 Revision 1*, “clearing” is a logical technique to sanitize data in all User Accessible storage locations for protection against simple non-invasive data recovery techniques using the same interface available to the user; typically applied through the standard read and write commands to the storage device.

Sanitization:

Per *NIST Special Publication 800-88 Revision 1*, “sanitization” is a process to render access to “Target Data” on the media infeasible for a given level of effort. In this document, clearing is the degree of sanitization described.