

COMPREHENSIVE SERVICES

We offer competitive repair and calibration services, as well as easily accessible documentation and free downloadable resources.

SELL YOUR SURPLUS

We buy new, used, decommissioned, and surplus parts from every NI series. We work out the best solution to suit your individual needs.

 Sell For Cash  Get Credit  Receive a Trade-In Deal

OBSOLETE NI HARDWARE IN STOCK & READY TO SHIP

We stock **New**, **New Surplus**, **Refurbished**, and **Reconditioned** NI Hardware.



Bridging the gap between the manufacturer and your legacy test system.

 1-800-915-6216

 www.apexwaves.com

 sales@apexwaves.com

All trademarks, brands, and brand names are the property of their respective owners.

Request a Quote

 **CLICK HERE**

NI-9401

GETTING STARTED GUIDE

NI 9401

8 DIO, 5 V/TTL, Bidirectional, 100 ns

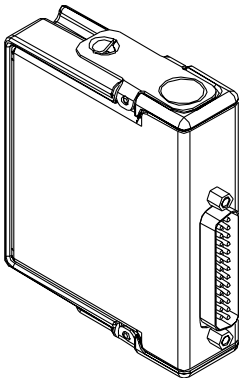

This document explains how to connect to the NI 9401.



Note Before you begin, complete the software and hardware installation procedures in your chassis documentation.



Note The guidelines in this document are specific to the NI 9401. The other components in the system might not meet the same safety ratings. Refer to the documentation for each component in the system to determine the safety and EMC ratings for the entire system.

Safety Guidelines

Operate the NI 9401 only as described in this document.



Caution Do not operate the NI 9401 in a manner not specified in this document. Product misuse can result in a hazard. You can compromise the safety protection built into the product if the product is damaged in any way. If the product is damaged, return it to NI for repair.

Safety Voltages

Connect only voltages that are within the following limits:

Maximum voltage¹

Channel-to-COM	±30 V maximum on one channel at a time, Measurement Category I
----------------	--

Isolation voltages

Channel-to-channel	None
--------------------	------

Channel-to-earth ground

Continuous	60 VDC, Measurement Category I
------------	--------------------------------

Withstand	1,000 Vrms, verified by a 5 s dielectric withstand test
-----------	---

Measurement Category I is for measurements performed on circuits not directly connected to the electrical distribution system

¹ The maximum voltage that can be applied or output between any channel and COM without damaging the module or other devices.

referred to as *MAINS* voltage. MAINS is a hazardous live electrical supply system that powers equipment. This category is for measurements of voltages from specially protected secondary circuits. Such voltage measurements include signal levels, special equipment, limited-energy parts of equipment, circuits powered by regulated low-voltage sources, and electronics.



Caution Do not connect the NI 9401 to signals or use for measurements within Measurement Categories II, III, or IV.



Note Measurement Categories CAT I and CAT O are equivalent. These test and measurement circuits are not intended for direct connection to the MAINS building installations of Measurement Categories CAT II, CAT III, or CAT IV.

Safety Guidelines for Hazardous Locations

The NI 9401 is suitable for use in Class I, Division 2, Groups A, B, C, D, T4 hazardous locations; Class I, Zone 2, AEx nA IIC T4 and Ex nA IIC T4 hazardous locations; and nonhazardous locations only. Follow these guidelines if you are installing the NI 9401 in a potentially explosive environment. Not following these guidelines may result in serious injury or death.



Caution Do not disconnect I/O-side wires or connectors unless power has been switched off or the area is known to be nonhazardous.



Caution Do not remove modules unless power has been switched off or the area is known to be nonhazardous.



Caution Substitution of components may impair suitability for Class I, Division 2.



Caution For Division 2 and Zone 2 applications, install the system in an enclosure rated to at least IP54 as defined by IEC/EN 60079-15.



Caution For Division 2 and Zone 2 applications, connected signals must be within the following limits.

Capacitance

0.2 μ F max

Special Conditions for Hazardous Locations Use in Europe and Internationally

The NI 9401 has been evaluated as Ex nA IIC T4 Gc equipment under DEMKO Certificate No. 03 ATEX 0324020X and is IECEx UL 14.0089X certified. Each NI 9401 is marked  II 3G

and is suitable for use in Zone 2 hazardous locations, in ambient temperatures of $-40\text{ }^{\circ}\text{C} \leq T_a \leq 70\text{ }^{\circ}\text{C}$. If you are using the NI 9401 in Gas Group IIC hazardous locations, you must use the device in an NI chassis that has been evaluated as Ex nC IIC T4, Ex IIC T4, Ex nA IIC T4, or Ex nL IIC T4 equipment.



Caution You must make sure that transient disturbances do not exceed 140% of the rated voltage.



Caution The system shall only be used in an area of not more than Pollution Degree 2, as defined in IEC 60664-1.



Caution The system shall be mounted in an ATEX/IECEx-certified enclosure with a minimum ingress protection rating of at least IP54 as defined in IEC/EN 60079-15.



Caution The enclosure must have a door or cover accessible only by the use of a tool.

Electromagnetic Compatibility Guidelines

This product was tested and complies with the regulatory requirements and limits for electromagnetic compatibility (EMC) stated in the product specifications. These requirements and

limits provide reasonable protection against harmful interference when the product is operated in the intended operational electromagnetic environment.

This product is intended for use in industrial locations. However, harmful interference may occur in some installations, when the product is connected to a peripheral device or test object, or if the product is used in residential or commercial areas. To minimize interference with radio and television reception and prevent unacceptable performance degradation, install and use this product in strict accordance with the instructions in the product documentation.

Furthermore, any changes or modifications to the product not expressly approved by National Instruments could void your authority to operate it under your local regulatory rules.



Caution To ensure the specified EMC performance, operate this product only with shielded cables and accessories.



Caution To ensure the specified EMC performance, you must install a clamp-on ferrite bead (782803-01) in accordance with the product installation instructions.

Cable Requirements for EMC Compliance

Select and install cables for the NI 9401 in accordance with the following requirements:

- Install a clamp-on ferrite bead (782803-01) on the cable that you are connecting to NI 9401.
- The clamp-on ferrite bead must be connected to the cable as close to the module as possible. Placing the ferrite elsewhere on the cable noticeably impairs its effectiveness.

Figure 1. Installing a Ferrite Bead

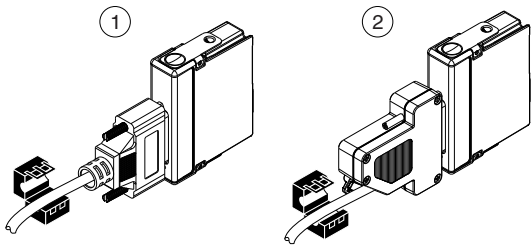

-
1. Installing a ferrite bead on a 25-pin DSUB cable.
 2. Installing a ferrite bead on the cable of the terminal block.
-

Special Conditions for Marine Applications

Some products are Lloyd's Register (LR) Type Approved for marine (shipboard) applications. To verify Lloyd's Register certification for a product, visit [ni.com/certification](https://www.lloydregister.com/certification) and search for the LR certificate, or look for the Lloyd's Register mark on the product.



Caution In order to meet the EMC requirements for marine applications, install the product in a shielded enclosure with shielded and/or filtered power and input/output ports. In addition, take precautions when designing, selecting, and installing measurement probes and cables to ensure that the desired EMC performance is attained.

Preparing the Environment

Ensure that the environment in which you are using the NI 9401 meets the following specifications.

Operating temperature (IEC 60068-2-1, IEC 60068-2-2)	-40 °C to 70 °C
---	-----------------

Operating humidity (IEC 60068-2-78)	10% RH to 90% RH, noncondensing
--	------------------------------------

Pollution Degree	2
------------------	---

Maximum altitude	2,000 m
------------------	---------

Indoor use only.



Note Refer to the device datasheet on ni.com/manuals for complete specifications.

Connecting the NI 9401

The NI 9401 provides connections for 8 digital input/output channels.

Figure 2. NI 9401 Pinout

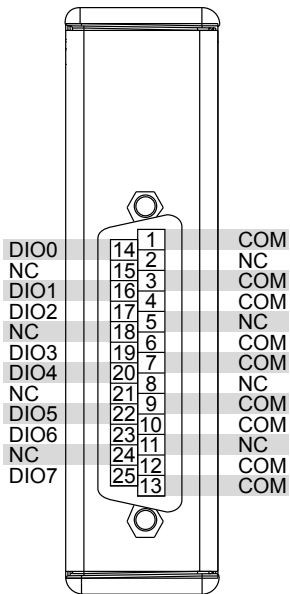

NI 9401 Signals

Table 1. Signal Descriptions

Signal	Description
COM	Common reference connection to isolated ground
DIO	Digital input/output signal connection
NC	No connection

Ports

The DIO channels are grouped in two ports, one containing channels 0, 1, 2, and 3, and one containing channels 4, 5, 6, and 7. You can independently configure each digital port in software for input or output. Note that all four channels in the port must share the same line direction.

Connecting a Serial Peripheral Interface Device

You can connect a Serial Peripheral Interface (SPI) device to the NI 9401.

Figure 3. Connecting an SPI Device to the NI 9401

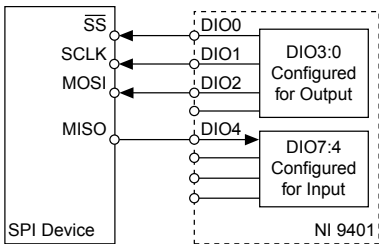

Connecting Digital Devices

You can connect several types of digital devices to the NI 9401.

Figure 4. Connecting Digital Devices to the NI 9401

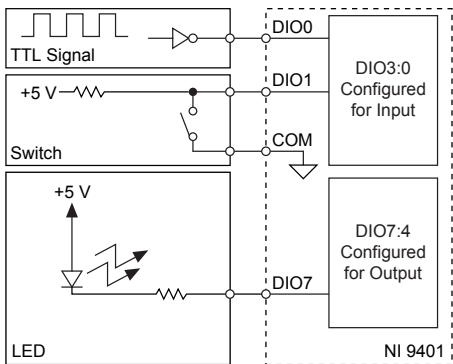

Overcurrent/Short-Circuit Protection

The overcurrent protection allows only a specified amount of current through the output channels to protect the NI 9401 from short circuits. If the NI 9401 goes into an overcurrent state, the

module sets all the DIO channels to high impedance for approximately 280 ms.

When the channels are in an overcurrent state, the NI 9401 can accept new line direction configuration and output state data but cannot pass valid input data to the software.

Where to Go Next

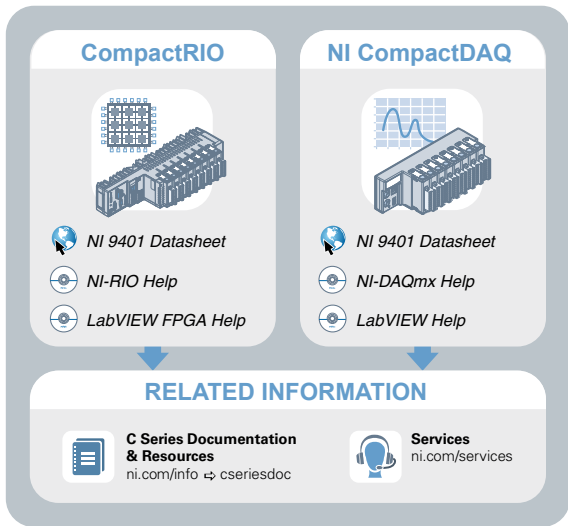

Located at ni.com/manuals

Installs with the software

Worldwide Support and Services

The NI website is your complete resource for technical support. At ni.com/support, you have access to everything from troubleshooting and application development self-help resources to email and phone assistance from NI Application Engineers.

Visit ni.com/services for NI Factory Installation Services, repairs, extended warranty, and other services.

Visit ni.com/register to register your NI product. Product registration facilitates technical support and ensures that you receive important information updates from NI.

A Declaration of Conformity (DoC) is our claim of compliance with the Council of the European Communities using the manufacturer's declaration of conformity. This system affords the user protection for electromagnetic compatibility (EMC) and product safety. You can obtain the DoC for your product by visiting ni.com/certification. If your product supports calibration, you can obtain the calibration certificate for your product at ni.com/calibration.

NI corporate headquarters is located at 11500 North Mopac Expressway, Austin, Texas, 78759-3504. NI also has offices located around the world. For telephone support in the United States, create your service request at ni.com/support or dial 1 866 ASK MYNI (275 6964). For telephone support outside the United States, visit the *Worldwide Offices* section of ni.com/niglobal to access the branch office websites, which provide up-to-date contact information, support phone numbers, email addresses, and current events.

Refer to the *NI Trademarks and Logo Guidelines* at ni.com/trademarks for information on NI trademarks. Other product and company names mentioned herein are trademarks or trade names of their respective companies. For patents covering NI products/technology, refer to the appropriate location: **Help»Patents** in your software, the `patents.txt` file on your media, or the *National Instruments Patent Notice* at ni.com/patents. You can find information about end-user license agreements (EULAs) and third-party legal notices in the readme file for your NI product. Refer to the *Export Compliance Information* at ni.com/legal/export-compliance for the NI global trade compliance policy and how to obtain relevant HTS codes, ECCNs, and other import/export data. NI MAKES NO EXPRESS OR IMPLIED WARRANTIES AS TO THE ACCURACY OF THE INFORMATION CONTAINED HEREIN AND SHALL NOT BE LIABLE FOR ANY ERRORS. U.S. Government Customers: The data contained in this manual was developed at private expense and is subject to the applicable limited rights and restricted data rights as set forth in FAR 52.227-14, DFAR 252.227-7014, and DFAR 252.227-7015.

© 2005—2015 National Instruments. All rights reserved.