

COMPREHENSIVE SERVICES

We offer competitive repair and calibration services, as well as easily accessible documentation and free downloadable resources.

SELL YOUR SURPLUS

We buy new, used, decommissioned, and surplus parts from every NI series. We work out the best solution to suit your individual needs.

 Sell For Cash  Get Credit  Receive a Trade-In Deal

OBSOLETE NI HARDWARE IN STOCK & READY TO SHIP

We stock **New**, **New Surplus**, **Refurbished**, and **Reconditioned** NI Hardware.



Bridging the gap between the manufacturer and your legacy test system.

 1-800-915-6216

 www.apexwaves.com

 sales@apexwaves.com

All trademarks, brands, and brand names are the property of their respective owners.

Request a Quote

 **CLICK HERE**

NI-9852

CAN

ECU Measurement and Calibration Toolkit User Manual

Worldwide Technical Support and Product Information

ni.com

National Instruments Corporate Headquarters

11500 North Mopac Expressway Austin, Texas 78759-3504 USA Tel: 512 683 0100

Worldwide Offices

Australia 1800 300 800, Austria 43 662 457990-0, Belgium 32 (0) 2 757 0020, Brazil 55 11 3262 3599,
Canada 800 433 3488, China 86 21 5050 9800, Czech Republic 420 224 235 774, Denmark 45 45 76 26 00,
Finland 358 (0) 9 725 72511, France 01 57 66 24 24, Germany 49 89 7413130, India 91 80 41190000,
Israel 972 3 6393737, Italy 39 02 41309277, Japan 0120-527196, Korea 82 02 3451 3400,
Lebanon 961 (0) 1 33 28 28, Malaysia 1800 887710, Mexico 01 800 010 0793, Netherlands 31 (0) 348 433 466,
New Zealand 0800 553 322, Norway 47 (0) 66 90 76 60, Poland 48 22 328 90 10, Portugal 351 210 311 210,
Russia 7 495 783 6851, Singapore 1800 226 5886, Slovenia 386 3 425 42 00, South Africa 27 0 11 805 8197,
Spain 34 91 640 0085, Sweden 46 (0) 8 587 895 00, Switzerland 41 56 2005151, Taiwan 886 02 2377 2222,
Thailand 662 278 6777, Turkey 90 212 279 3031, United Kingdom 44 (0) 1635 523545

For further support information, refer to the *Technical Support and Professional Services* appendix. To comment on National Instruments documentation, refer to the National Instruments Web site at ni.com/info and enter the Info Code feedback.

Important Information

Warranty

The media on which you receive National Instruments software are warranted not to fail to execute programming instructions, due to defects in materials and workmanship, for a period of 90 days from date of shipment, as evidenced by receipts or other documentation. National Instruments will, at its option, repair or replace software media that do not execute programming instructions if National Instruments receives notice of such defects during the warranty period. National Instruments does not warrant that the operation of the software shall be uninterrupted or error free.

A Return Material Authorization (RMA) number must be obtained from the factory and clearly marked on the outside of the package before any equipment will be accepted for warranty work. National Instruments will pay the shipping costs of returning to the owner parts which are covered by warranty.

National Instruments believes that the information in this document is accurate. The document has been carefully reviewed for technical accuracy. In the event that technical or typographical errors exist, National Instruments reserves the right to make changes to subsequent editions of this document without prior notice to holders of this edition. The reader should consult National Instruments if errors are suspected. In no event shall National Instruments be liable for any damages arising out of or related to this document or the information contained in it.

EXCEPT AS SPECIFIED HEREIN, NATIONAL INSTRUMENTS MAKES NO WARRANTIES, EXPRESS OR IMPLIED, AND SPECIFICALLY DISCLAIMS ANY WARRANTY OF MERCHANTABILITY OR FITNESS FOR A PARTICULAR PURPOSE. CUSTOMER'S RIGHT TO RECOVER DAMAGES CAUSED BY FAULT OR NEGLIGENCE ON THE PART OF NATIONAL INSTRUMENTS SHALL BE LIMITED TO THE AMOUNT THEREFORE PAID BY THE CUSTOMER. NATIONAL INSTRUMENTS WILL NOT BE LIABLE FOR DAMAGES RESULTING FROM LOSS OF DATA, PROFITS, USE OF PRODUCTS, OR INCIDENTAL OR CONSEQUENTIAL DAMAGES, EVEN IF ADVISED OF THE POSSIBILITY THEREOF. This limitation of the liability of National Instruments will apply regardless of the form of action, whether in contract or tort, including negligence. Any action against National Instruments must be brought within one year after the cause of action accrues. National Instruments shall not be liable for any delay in performance due to causes beyond its reasonable control. The warranty provided herein does not cover damages, defects, malfunctions, or service failures caused by owner's failure to follow the National Instruments installation, operation, or maintenance instructions; owner's modification of the product; owner's abuse, misuse, or negligent acts; and power failure or surges, fire, flood, accident, actions of third parties, or other events outside reasonable control.

Copyright

Under the copyright laws, this publication may not be reproduced or transmitted in any form, electronic or mechanical, including photocopying, recording, storing in an information retrieval system, or translating, in whole or in part, without the prior written consent of National Instruments Corporation.

National Instruments respects the intellectual property of others, and we ask our users to do the same. NI software is protected by copyright and other intellectual property laws. Where NI software may be used to reproduce software or other materials belonging to others, you may use NI software only to reproduce materials that you may reproduce in accordance with the terms of any applicable license or other legal restriction.

Trademarks

CVI, LabVIEW, National Instruments, NI, ni.com, the National Instruments corporate logo, and the Eagle logo are trademarks of National Instruments Corporation. Refer to the *Trademark Information* at ni.com/trademarks for other National Instruments trademarks.

The mark LabWindows is used under a license from Microsoft Corporation. Windows is a registered trademark of Microsoft Corporation in the United States and other countries. Other product and company names mentioned herein are trademarks or trade names of their respective companies.

Members of the National Instruments Alliance Partner Program are business entities independent from National Instruments and have no agency, partnership, or joint-venture relationship with National Instruments.

Patents

For patents covering National Instruments products/technology, refer to the appropriate location: **Help»Patents** in your software, the `patents.txt` file on your media, or the *National Instruments Patent Notice* at ni.com/patents.

WARNING REGARDING USE OF NATIONAL INSTRUMENTS PRODUCTS

(1) NATIONAL INSTRUMENTS PRODUCTS ARE NOT DESIGNED WITH COMPONENTS AND TESTING FOR A LEVEL OF RELIABILITY SUITABLE FOR USE IN OR IN CONNECTION WITH SURGICAL IMPLANTS OR AS CRITICAL COMPONENTS IN ANY LIFE SUPPORT SYSTEMS WHOSE FAILURE TO PERFORM CAN REASONABLY BE EXPECTED TO CAUSE SIGNIFICANT INJURY TO A HUMAN.

(2) IN ANY APPLICATION, INCLUDING THE ABOVE, RELIABILITY OF OPERATION OF THE SOFTWARE PRODUCTS CAN BE IMPAIRED BY ADVERSE FACTORS, INCLUDING BUT NOT LIMITED TO FLUCTUATIONS IN ELECTRICAL POWER SUPPLY, COMPUTER HARDWARE MALFUNCTIONS, COMPUTER OPERATING SYSTEM SOFTWARE FITNESS, FITNESS OF COMPILERS AND DEVELOPMENT SOFTWARE USED TO DEVELOP AN APPLICATION, INSTALLATION ERRORS, SOFTWARE AND HARDWARE COMPATIBILITY PROBLEMS, MALFUNCTIONS OR FAILURES OF ELECTRONIC MONITORING OR CONTROL DEVICES, TRANSIENT FAILURES OF ELECTRONIC SYSTEMS (HARDWARE AND/OR SOFTWARE), UNANTICIPATED USES OR MISUSES, OR ERRORS ON THE PART OF THE USER OR APPLICATIONS DESIGNER (ADVERSE FACTORS SUCH AS THESE ARE HEREAFTER COLLECTIVELY TERMED "SYSTEM FAILURES"). ANY APPLICATION WHERE A SYSTEM FAILURE WOULD CREATE A RISK OF HARM TO PROPERTY OR PERSONS (INCLUDING THE RISK OF BODILY INJURY AND DEATH) SHOULD NOT BE RELIANT SOLELY UPON ONE FORM OF ELECTRONIC SYSTEM DUE TO THE RISK OF SYSTEM FAILURE. TO AVOID DAMAGE, INJURY, OR DEATH, THE USER OR APPLICATION DESIGNER MUST TAKE REASONABLY PRUDENT STEPS TO PROTECT AGAINST SYSTEM FAILURES, INCLUDING BUT NOT LIMITED TO BACK-UP OR SHUT DOWN MECHANISMS. BECAUSE EACH END-USER SYSTEM IS CUSTOMIZED AND DIFFERS FROM NATIONAL INSTRUMENTS' TESTING PLATFORMS AND BECAUSE A USER OR APPLICATION DESIGNER MAY USE NATIONAL INSTRUMENTS PRODUCTS IN COMBINATION WITH OTHER PRODUCTS IN A MANNER NOT EVALUATED OR CONTEMPLATED BY NATIONAL INSTRUMENTS, THE USER OR APPLICATION DESIGNER IS ULTIMATELY RESPONSIBLE FOR VERIFYING AND VALIDATING THE SUITABILITY OF NATIONAL INSTRUMENTS PRODUCTS WHENEVER NATIONAL INSTRUMENTS PRODUCTS ARE INCORPORATED IN A SYSTEM OR APPLICATION, INCLUDING, WITHOUT LIMITATION, THE APPROPRIATE DESIGN, PROCESS AND SAFETY LEVEL OF SUCH SYSTEM OR APPLICATION.

Contents

About This Manual

Conventions	xi
Related Documentation.....	xii

Chapter 1

Introduction

CAN Calibration Protocol (CCP) Overview	1-2
CCP Protocol Version	1-2
Universal Measurement and Calibration Protocol (XCP) Overview.....	1-3
XCP Protocol Version	1-3
Measurement and Calibration Databases.....	1-4
ECU Measurements	1-4
ECU Characteristics.....	1-4

Chapter 2

Installation and Configuration

Installation	2-1
License Management Overview	2-1
Activate ECU M&C Toolkit.....	2-2
Terms	2-3
Moving Software After Activation.....	2-4
Volume License Program	2-4
Online Activation	2-4
Home Computer Use	2-4
Privacy Policy.....	2-4
LabVIEW Real-Time (RT) Configuration	2-5
PXI System.....	2-5
NI-CAN on PXI RT System.....	2-5
NI-XNET on PXI RT System.....	2-5
CompactRIO System	2-5
DOS Command Prompt.....	2-6
Web Browsers	2-7
LabVIEW Real-Time Graphical File Transfer Utility	2-7
LabVIEW	2-9
Hardware and Software Requirements	2-10

Chapter 3 Application Development

Choose the Programming Language	3-1
LabVIEW	3-1
LabWindows/CVI	3-1
Visual C++ 6	3-2
Other Programming Languages	3-3
Application Development on CompactRIO or R Series	3-4
Transferring Data between the FPGA and Host Computer	3-4
Customizing the CAN Bridge (FPGA) VI	3-5
Debugging An Application	3-5
NI-Spy	3-5
XCP-Spy	3-5
Saving Captured Communication Data	3-7
Capture Options	3-7
Call History Depth	3-7
Capturing Data	3-7
Selecting Which XCP Commands to View	3-7

Chapter 4 Using the ECU M&C API

Structure of the ECU M&C API	4-1
ECU M&C Channel Functions	4-2
What is an ECU Measurement?	4-2
What is an ECU Characteristic?	4-2
ECU M&C CCP and XCP Functions	4-3
Basic Programming Model	4-3
ECU Open	4-5
ASAM MCD 2MC Communication Properties for CCP or XCP with CAN	4-5
CRO ID	4-5
DTO ID	4-5
Station Address	4-5
Baudrate	4-6
ASAM MCD 2MC Communication Properties for XCP with UDP or TCP	4-6
IP Address or hostname	4-6
Port number	4-6
ECU Connect	4-6
ECU Disconnect	4-7
ECU Close	4-7

Characteristic Read and Write.....	4-7
Access Characteristics.....	4-7
Characteristic Read	4-8
Characteristic Write	4-8
Measurement Task.....	4-9
DAQ Initialize.....	4-10
DAQ Start Stop	4-10
DAQ Read.....	4-11
DAQ Write	4-12
DAQ Clear	4-13
Memory Programming	4-13
Program Start	4-14
Clear Memory	4-15
Program.....	4-15
Program Reset.....	4-15
Optional Steps for the XCP Protocol	4-15
Additional Programming Topics	4-16
Get Names	4-16
Set/Get Properties	4-16
Generic CCP Functions	4-17
Generic XCP Functions.....	4-18
Seed and Key Algorithm	4-19
Definition for Seed and Key Algorithm.....	4-19
Seed and Key Example	4-20
Checksum Algorithm	4-21
Seed and Key and Checksum Algorithms for VxWorks Targets	4-23

Chapter 5

ECU M&C API for LabVIEW

Section Headings	5-1
Purpose	5-1
Format.....	5-1
Input and Output.....	5-1
Description	5-1
List of VIs	5-1
MC Build Checksum.vi.....	5-5
MC Calc Checksum.vi.....	5-8
MC CCP Action Service.vi	5-11
MC CCP Diag Service.vi	5-13
MC CCP Get Active Cal Page.vi	5-15
MC CCP Get Result.vi	5-17
MC CCP Get Session Status.vi	5-19
MC CCP Get Version.vi.....	5-21

MC CCP Move Memory.vi.....	5-23
MC CCP Select Cal Page.vi.....	5-25
MC CCP Set Session Status.vi.....	5-27
MC Characteristic Read.vi.....	5-29
MC Characteristic Read Single Value.vi	5-31
MC Characteristic Write.vi	5-33
MC Characteristic Write Single Value.vi	5-35
MC Clear Memory.vi.....	5-37
MC Conversion Create.vi	5-39
MC DAQ Clear.vi.....	5-41
MC DAQ Initialize.vi	5-43
MC DAQ List Initialize.vi	5-46
MC DAQ Read.vi	5-49
MC DAQ Start Stop.vi.....	5-55
MC DAQ Write.vi.....	5-57
MC Database Close.vi.....	5-60
MC Database Open.vi	5-62
MC Download.vi.....	5-64
MC ECU Close.vi	5-66
MC ECU Connect.vi	5-68
MC ECU Create.vi.....	5-70
MC ECU Deselect.vi.....	5-74
MC ECU Disconnect.vi	5-76
MC ECU Open.vi.....	5-78
MC ECU Select.vi.....	5-82
MC Event Create.vi.....	5-86
MC Generic.vi.....	5-88
MC Get Names.vi	5-90
MC Get Property.vi.....	5-92
MC Measurement Create.vi	5-117
MC Measurement Read.vi	5-119
MC Measurement Write.vi	5-121
MC Program.vi.....	5-123
MC Program Reset.vi.....	5-125
MC Program Start.vi	5-127
MC Set Property.vi	5-129
MC Upload.vi.....	5-142
MC XCP Copy Cal Page.vi.....	5-144
MC XCP Get Cal Page.vi	5-146
MC XCP Get ID.vi.....	5-148
MC XCP Get Status.vi	5-150
MC XCP Program Prepare.vi.....	5-155
MC XCP Program Verify.vi	5-157

MC XCP Set Cal Page.vi.....	5-160
MC XCP Set Request.vi.....	5-162
MC XCP Set Segment Mode.vi.....	5-165

Chapter 6

ECU M&C API for C

Section Headings	6-1
Purpose	6-1
Format.....	6-1
Input and Output.....	6-1
Description	6-1
List of Data Types.....	6-1
List of Functions	6-2
mcBuildChecksum	6-6
mcCalculateChecksum	6-10
mcCCPActionService.....	6-12
mcCCPDiagService.....	6-14
mcCCPGetActiveCalPage.....	6-16
mcCCPGetResult.....	6-17
mcCCPGetSessionStatus.....	6-18
mcCCPGetVersion	6-19
mcCCPMoveMemory.....	6-20
mcCCPSelectCalPage.....	6-22
mcCCPSetSessionStatus.....	6-23
mcCharacteristicRead.....	6-25
mcCharacteristicReadSingleValue.....	6-26
mcCharacteristicWrite	6-28
mcCharacteristicWriteSingleValue	6-29
mcClearMemory.....	6-31
mcConversionCreate	6-32
mcDAQClear	6-34
mcDAQInitialize	6-35
mcDAQListInitialize	6-38
mcDAQRead	6-40
mcDAQReadTimestamped.....	6-43
mcDAQStartStop.....	6-46
mcDAQWrite	6-48
mcDatabaseClose	6-50
mcDatabaseOpen.....	6-51
mcDownload.....	6-52
mcECUConnect.....	6-54
mcECUCreate.....	6-55
mcECUDeselect	6-58

mcECUDisconnect.....	6-59
mcECUSelectEx.....	6-60
mcEventCreate.....	6-63
mcGeneric.....	6-64
mcGetNames.....	6-66
mcGetNamesLength.....	6-68
mcGetProperty.....	6-70
mcMeasurementCreate.....	6-82
mcMeasurementRead.....	6-84
mcMeasurementWrite.....	6-85
mcProgram.....	6-86
mcProgramReset.....	6-88
mcProgramStart.....	6-89
mcSetProperty.....	6-90
mcStatusToString.....	6-99
mcUpload.....	6-101
mcXCPCopyCalPage.....	6-103
mcXCPGetCalPage.....	6-105
mcXCPGetID.....	6-107
mcXCPGetStatus.....	6-109
mcXCPProgramPrepare.....	6-113
mcXCPProgramVerify.....	6-115
mcXCPSetCalPage.....	6-117
mcXCPSetRequest.....	6-119
mcXCPSetSegmentMode.....	6-121

Appendix A

Summary of the CCP Standard

Appendix B

Technical Support and Professional Services

Glossary

Index

About This Manual

This manual provides instructions for using the ECU Measurement & Calibration (ECU M&C) Toolkit. It contains information about installation, configuration, and troubleshooting, and also contains ECU M&C function references for LabVIEW-based and C-based APIs.

Use the ECU M&C Toolkit Installation Guide in the jewel case of the program CD to install the ECU M&C Toolkit software. Use this manual to learn the basics of ECU Measurement and Calibration, as well as how to develop an application.

Conventions

The following conventions appear in this manual:

»

The » symbol leads you through nested menu items and dialog box options to a final action. The sequence **Options»Settings»General** directs you to pull down the **Options** menu, select the **Settings** item, and select **General** from the last dialog box.



This icon denotes a tip, which alerts you to advisory information.



This icon denotes a note, which alerts you to important information.

bold

Bold text denotes items that you must select or click in the software, such as menu items and dialog box options. Bold text also denotes parameter names.

italic

Italic text denotes variables, emphasis, a cross-reference, or an introduction to a key concept. Italic text also denotes text that is a placeholder for a word or value that you must supply.

monospace

Text in this font denotes text or characters that you should enter from the keyboard, sections of code, programming examples, and syntax examples. This font is also used for the proper names of disk drives, paths, directories, programs, subprograms, subroutines, device names, functions, operations, variables, filenames, and extensions.

monospace italic

Italic text in this font denotes text that is a placeholder for a word or value that you must supply.

Related Documentation

The following documents contain information that you may find helpful as you read this manual:

- *ANSI/ISO Standard 11898-1993, Road Vehicles—Interchange of Digital Information—Controller Area Network (CAN) for High-Speed Communication*
- *CAN Specification Version 2.0*, 1991, Robert Bosch GmbH., Postfach 106050, D-70049 Stuttgart 1
- *CiA Draft Standard 102, Version 2.0*, CAN Physical Layer for Industrial Applications
- *CAN Calibration Protocol Specification, Version 2.1*, ASAP Arbeitskreis zur Standardisierung von Applikationssystemen Standardization of Application/Calibration Systems task force
- *Interface Specification Interface 2 (ASAM MCD 2MC/ASAP2) Version 1.51 Release 2003-03-11*, Applications Systems Standardization Working Group
- *XCP Version 1.0, The Universal Measurement and Calibration Protocol Family*, Association for Standardization of Automation and Measuring Systems:
 - *Part 1, Overview*
 - *Part 2, Protocol Layer Specification*
 - *Part 3, XCP on CAN - Transport Layer Specification*
 - *Part 3, XCP on Ethernet - Transport Layer Specification*
 - *Part 4, Interface Specification*
- *NI-CAN Hardware and Software Manual*

Introduction

The ECU Measurement and Calibration (ECU M&C) Toolkit contains a development system for an electronic control unit (ECU) based on existing ASAM standards. The function set of the ECU M&C Toolkit enables engineers to optimize and verify the functionality of electronic controller devices. Most ECUs interact with other ECUs, external sensors, and actuators in a Controller Area Network (CAN). During the development and verification phase of an ECU, engineers access the ECU for acquired data (Measurement), or to adjust parameters inside the ECU itself (calibration). Since the bandwidth and number of identifiers for a CAN network are limited the Association for Standardization of Automation and Measuring Systems (ASAM e.V.) has specified the CAN Calibration Protocol (CCP), a protocol layer based on CAN, to access the measurement and calibration data in an ECU.

To build on the functionality of the CAN Calibration Protocol (CCP), ASAM defined the new protocol specification XCP (Universal Measurement and Calibration Protocol) which can be considered an improved and generalized version of CCP. The X represents the various transportation layers used by the members of the XCP protocol family—for instance, XCP on CAN, XCP on TCP/IP, XCP on UDP/IP, XCP on USB, etc.

The ECU M&C Toolkit is particularly suited to the automotive industry and their component suppliers. It provides a function set that can be used in the development or verification phase of an ECU. Access to the data inside an ECU takes place based on information stored in an ASAM MCD 2MC (*.A2L) database file provided by the ECU supplier. Selecting each signal by its name provides convenient access to the data inside an ECU. The ECU M&C Toolkit uses CCP and XCP as the fundamental communication protocols and to support ECU database (*.A2L) files. You can easily switch between the CCP and XCP protocol layers through software.

CAN Calibration Protocol (CCP) Overview

The CAN Calibration Protocol is a CAN-based master-slave protocol for calibration and data acquisition. A single master device (host) can be connected to one or more slave devices. The host must establish a logical point-to-point connection to the slave device before the slave device may accept commands from the host. The slave device must acknowledge each command received from the host within a specified time after the connection between host and slave has been established.

CCP defines two function sets—one for control/memory transfer and one for data acquisitions that are independent of each other and may run asynchronously. The control commands are used to carry out functions in the slave device and may use the slave to perform tasks on other devices. The data acquisition commands are used for continuous data acquisition from a slave device. The devices continuously transmit internal data according to a list that has been configured by the host. Data acquisition is initiated by the host, then executed by the slave device, and may be based on a fixed sampling rate or be event-driven.

The communication of controllers with a master device through CCP is based on the CAN 2.0B standard (11-bit and 29-bit identifier), which includes 2.0A (11-bit identifier) for data acquisition from the controllers, memory transfers to the controllers, and control functions in the controllers for calibration.

The ECU M&C Toolkit abstracts the CCP communication layer so that it is transparent to the user. For most cases it is sufficient that the underlying CCP communication is handled by the toolkit kernel itself. Nevertheless, the ECU M&C Toolkit offers direct access to the low level CCP commands if a non-standard timing behavior or independent user defined command sequence is needed.

CCP Protocol Version

The ECU M&C Toolkit supports the CAN Calibration Protocol specification, version 2.1.

Universal Measurement and Calibration Protocol (XCP) Overview

The Universal Measurement and Calibration Protocol (XCP) is a single-master/single-slave protocol for calibration and data acquisition based on various transport layers. Communication is always initiated by the XCP master. An XCP slave must respond to requests from the master within a specified time. The XCP protocol uses a *soft* master/slave principle: once the master establishes a communication channel with the slave, the slave can send certain messages (Events, Service Requests and Data Acquisition messages) autonomously. In addition, the master sends Data Stimulation messages without expecting a direct response from the slave.

The XCP builds a continuous, logical, unambiguous point-to-point connection with 1 specific slave when establishing a communication channel. The XCP slave cannot handle multiple connections. The master is not allowed to broadcast XCP messages to multiple slaves at the same time. The identification parameters of the Transport Layer (for instance, CAN identifiers on CAN) must be chosen in such a way that they build independent and unambiguously distinguishable communication channels.

The ECU M&C Toolkit abstracts the XCP communication layer so that it is transparent to the user. For most cases it is sufficient that the underlying XCP communication is handled by the toolkit kernel. Nevertheless, the ECU M&C Toolkit offers direct access to the low level XCP commands if a non-standard timing behavior or independent user defined command sequence is required.

XCP Protocol Version

The ECU M&C Toolkit supports the *XCP Calibration Protocol Specification*, version 1.0.

For further information related to the XCP protocol, refer to the *XCP Calibration Protocol Specification*, version 1.0, *The Universal Measurement and Calibration Protocol Family, Part 1*, by ASAM e.V.

Measurement and Calibration Databases

The ASAP description file (ASAP2 or ASAM MCD 2MC) is used to describe the ECU internal memory configuration. An ASAM MCD 2MC description file with the file extension `.A2L` contains information and access locations for the relevant data objects in the ECU, such as:

- Project relevant information
- ECU data structure
- Conversion procedures for representation in physical units
- Descriptions of the available Measurement channels inside the ECU
- Descriptions of the available Characteristics inside the ECU
- Descriptions of how to access the ECU over CAN



Note Use of the ECU M&C Toolkit requires an existing ASAM MCD 2MC database file. These files can be generated by various third-party utilities. A database editor for ASAM MCD 2MC databases is not part of the ECU M&C Toolkit.

ECU Measurements

The ECU M&C Toolkit provides the user access to ECU internal physical values defined by their names in the ASAM MCD 2MC database file. Based on this information, the ECU M&C Toolkit communicates through CCP or XCP to the ECU. A DAQ (data acquisition) list can be set up, which sends ECU internal data synchronously or asynchronously to the CCP or XCP master. The ECU M&C Toolkit provides a way to configure several Measurement channels into a single Measurement task. The term *task* refers to a list of measurements (channels) read or written together. A common use of the *task* concept is to read DAQ channels available on the ECU.

ECU Characteristics

ECU *Characteristics* are maps of ECU internal variables, which may be used as calibration information or set-point information. The ECU memory content of Characteristics can be read or even changed with the help of the ECU M&C Toolkit.

Installation and Configuration

This chapter explains how to install and configure the ECU M&C Toolkit.

Installation

This section discusses the installation of the ECU M&C Toolkit for Microsoft Windows.



Note You need administrator rights to install the ECU M&C Toolkit on your computer.

1. Insert the *ECU M&C Toolkit* CD into the CD-ROM drive.
2. Open Windows Explorer.
3. Access the CD-ROM drive.
4. Double-click on `autorun.exe`. This will launch the software interface.
5. Start the installation. The installation program will guide you through the rest of the installation process.
6. When installation is complete, the National Instruments License Manager will launch automatically to activate your license.

License Management Overview

License management is the process of controlling access to products based on an explicit license agreement. The ECU M&C Toolkit requires an activated license in order to launch, so a license must be acquired and activated before the product can be used. The activation process involves using the Activation Wizard to send the following information to National Instruments:

- The product you are activating: *ECU Measurement and Calibration Toolkit*
- The serial number of the product
- The version of the product
- Your name

- Your organization
- A computer ID that uniquely identifies your system

National Instruments uses this information to generate an activation code, which is used to activate the ECU M&C Toolkit on your system. National Instruments does not use this information for any other purpose. Refer to the [Privacy Policy](#) section for information on the National Instruments privacy policy regarding your personal information.

The Activation Wizard offers a variety of options you can use to obtain an activation code from National Instruments, including an automatic option through an Internet connection, or through email, by telephone, or by fax.

Activate ECU M&C Toolkit

The ECU M&C Toolkit must be activated before using it, in accordance with its license agreement. To activate the ECU M&C Toolkit, you must first purchase a license. For information on purchasing licenses, contact your local National Instruments sales representative or visit ni.com.

Once you have purchased a license, you can activate your product using the Activation Wizard. Activation is simple and you can activate your software 24 hours a day, 7 days a week.

Complete the following steps to activate the ECU M&C Toolkit.

1. Locate your serial number.

Your serial number uniquely identifies your purchase of NI software. You can find it on the *Certificate of Ownership* included in your software kit. If you subscribe to NI Developer Suite or Academic Software Solutions, use the original serial number you received with your initial purchase.

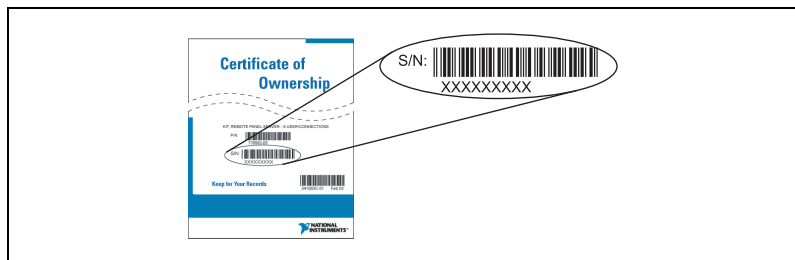

2. Install your software.

3. Launch the License Activation Wizard.

If you installed your software for the first time and the installer did *not* launch the License Activation Wizard for you, perform the following steps:

- a. Launch the NI License Manager by selecting **Start»Programs»National Instruments»NI License Manager**.
- b. Click the **Activate** button on the toolbar.

The wizard will guide you through the activation process.

4. Save your activation code for future use (optional).

You can reactivate your software at any time. The activation wizard provides you with the option to receive an email confirmation of your activation code. To apply this activation code in the future, launch the Activation Wizard and choose to apply a 20-character activation code. If you reinstall your software on the same computer, the same activation code will work.

For more information on activation, refer to your product documentation, or visit ni.com/activate.

National Instruments uses activation to better support evaluation of our software, to enable additional software features, and to support license management in large organizations. To find out more about National Instruments software licensing, visit ni.com/activate to find frequently asked questions, resources, and technical support.

Terms

Table 1. Definition of Activation Terms

Serial Number	A 9-character, alphanumeric string that uniquely identifies your purchase of a single copy of software, included in your software kit on your <i>Certificate of Ownership</i> . The serial number for hardware products is printed either on the product box or on the device.
Computer ID or Device ID	A 16-character ID that uniquely identifies your computer or NI hardware, generated during the activation process.
Activation Code	A 20-character code that enables NI software to run on your computer, based on your serial number and computer ID. You generate and install an activation code by completing the activation process.

Moving Software After Activation

To transfer your software to another computer, install and reactivate it on the second computer. You are not prohibited from transferring your software from one computer to another. Because activation codes are unique to each computer, you will need a new activation code. Follow the steps on the previous page to acquire a new activation code and reactivate your software.

Volume License Program

National Instruments offers volume licenses through the NI Volume License Program. The NI Volume License Program makes managing software licenses and maintenance easy. For more information, refer to ni.com/vlp.

Online Activation

Activation is available on ni.com/activate 24 hours a day, 7 days a week. You can retrieve an activation code from any computer that has an Internet connection. NI does not require that the computer on which you run NI software have Internet or email access.

Home Computer Use

National Instruments permits you to use this software at home. Refer to the NI License Manager help file or the software end-user license agreement in the installer or online at ni.com/legal/license for more information.

Privacy Policy

National Instruments respects your privacy. For more information about the National Instruments activation information privacy policy, go to ni.com/activate/privacy.

Upon successful activation, you can use the product immediately.



Note If the ECU M&C Toolkit was in use before you began the activation process, you may need to restart it for the change to take effect.



Tip In the NI License Manager, products that have not been activated are denoted either by a yellow stoplight or a red stoplight, depending whether the product is in evaluation mode or is unusable. Activated products are denoted by a green stoplight.

LabVIEW Real-Time (RT) Configuration

LabVIEW Real-Time (RT) combines easy-to-use LabVIEW programming with the power of real-time systems.

PXI System

When you use a National Instruments PXI controller as a LabVIEW RT system, you can install a PXI CAN or PXI XNET card and use the ECU M&C Toolkit to develop real-time applications for CCP or XCP. As with any other NI product for LabVIEW RT, you must download the ECU M&C Toolkit software to the LabVIEW RT system using the **Remote Systems** branch in MAX. For more information, refer to the LabVIEW RT documentation.

After installing the PXI CAN cards and downloading the NI-CAN or NI-XNET and ECU M&C Toolkit software to the LabVIEW RT system, you need to verify the installation.

NI-CAN on PXI RT System

Within the MAX **Tools** menu, select **NI-CAN»RT Hardware Configuration**. The RT Hardware Configuration tool provides features similar to **Devices and Interfaces** on the local system. Use the RT Hardware Configuration tool to self-test the CAN cards and assign an interface name to each physical CAN port.

NI-XNET on PXI RT System

After you install the PXI XNET cards and download the NI-XNET software to the LabVIEW RT system, you need to verify the installation. Find your PXI target device in MAX under **Network Devices** and expand the tree. Browse to **Devices and Interfaces** and open the **NI-XNET Devices** group. Perform a self-test for all installed NI-XNET devices. On the RT target, you can configure your NI-XNET hardware the same way as on the local system.

CompactRIO System

After you have installed the CompactRIO CAN modules and downloaded the NI-RIO and ECU M&C Toolkit software, you need to enable the CompactRIO Reconfigurable Embedded Chassis for use in LabVIEW. For more information, refer to the MAX help.



Note You can use the ECU M&C Toolkit with LabVIEW 2009 or newer on CompactRIO Systems only.

To use the ECU M&C Toolkit on the LabVIEW RT system, you must also download the ASAM MCD 2MC database file to the RT target. The LabVIEW Real-Time Engine that runs on the PXI LabVIEW Real-Time controller supports a File Transfer Protocol (FTP) server. You can access the LabVIEW RT target FTP server using any standard FTP utility for transferring files to and from the hard drive or compact flash. The following sections demonstrate how to transfer files from and to your LabVIEW Real-Time target using various FTP clients.

DOS Command Prompt

You can run a native FTP client from the DOS command prompt on a Windows PC. To open the FTP client, click **Start>Run** to open the user-command dialog box. Type `command`, and click **Enter**. This opens a window with a DOS prompt.

Then use the following table to enter a sequence of commands that may be used to access the FTP server of your RT target.



Note `w.x.y.z` represents the IP address of the RT target in this document.

Table 2-1. Example of FTP Transfer

Command	Result
ftp	Open a connection to the FTP server.
open <code>w.x.y.z</code>	
(username)	Enter your username and password here or press the Enter key twice if these security settings have not been applied.
(password)	
help	View a list of commands.
cd <code>ni-rt\system\www</code>	Change to the desired directory.
dir	View the files present.
get <code>index.htm c:\index.htm</code>	Copy the file.
cd \	Change directory back to the root (<code>c:\</code>).
cd <code>d:</code>	Change directories to the external compact flash.

Table 2-1. Example of FTP Transfer (Continued)

Command	Result
put c:\index.htm index.htm	Copy the file from the FTP client machine to the target.
dir	Verify the copied file on the target.
cd c:	Change directory back to the internal compact flash or hard drive.
quit	Disconnect from the FTP server.

Web Browsers

You can also use Internet Explorer or Netscape Navigator to ftp files to and from the controller. This is an easier method of transfer, since there is no need to learn ftp commands—instead the files are simply copied and pasted as they would be in a Windows Explorer window. The disadvantage of this method is that Internet Explorer sometimes caches old information, so you will need to refresh occasionally.

If *w.x.y.z* is the IP address of your RT target, open Internet Explorer to access the hard drive or internal compact flash, or type the following in the address field:

```
ftp://w.x.y.z/
```

If a username and password are required, then use the following format:

```
ftp://username:password@w.x.y.z/
```

To access the external compact flash, open Internet Explorer and type the following in the address field:

```
ftp://w.x.y.z/d:/
```

To enter a directory, double-click on its icon. Right-click on a file or folder and choose cut, copy, paste or delete to perform those actions.

LabVIEW Real-Time Graphical File Transfer Utility

LabVIEW Real-Time Module versions 7.0 and later include a File Transfer Utility that can be used to access your RT target. This method helps you avoid the caching problem encountered when using web browsers. You can find this utility in the Measurement and Automation Explorer (MAX). To open the utility, right-click on the desired RT target under the **Remote Systems** list and choose **File Transfer**, as shown in Figure 2-2.

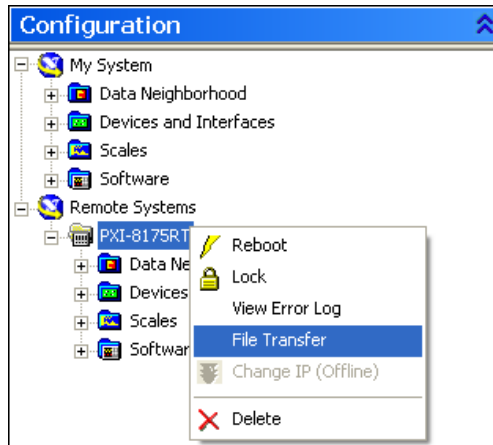

Figure 2-2. FTP Utility Access in MAX

At this point, you are prompted for a username and password. If these security features have not been enabled, check the **Anonymous Login** box as shown in Figure 2-3.



Figure 2-3. FTP Login Dialog Box

The upper section of the utility interface shows the current directory and contents on the remote RT target, while the lower section gives information for the host or local machine. To copy a file (`TestECU.a21`, for instance) to the RT target, complete the following steps, referring to Figure 2-4 for details.

1. In the Current Directory section, navigate through the tree structure to the System folder.
2. In the local directory section, navigate through the tree structure to the location of the file you want to transfer and highlight the file.
3. Click the **To Remote** button to copy the file.

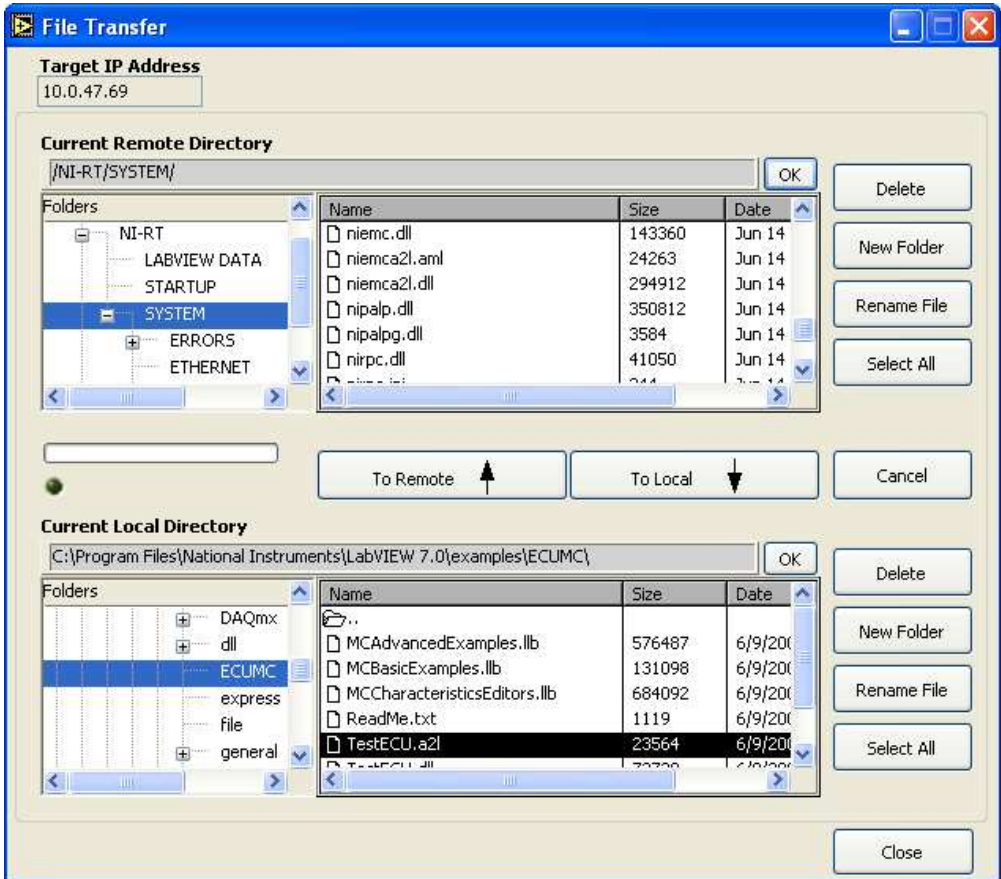

Figure 2-4. Transferring Files With the FTP Utility

LabVIEW

You also can use LabVIEW to programmatically access the FTP server of a LabVIEW Real-Time target.

The **DataSocket Read** function has the ability to read raw text, tabbed text, and .wav files from an FTP server. For more information on this, refer to the *LabVIEW User Manual*.

The *LabVIEW Internet Developers Toolkit* allows you to send files or raw data to an FTP server, as well as sending emails and adding security to your web-based applications.

Hardware and Software Requirements

You can use the ECU M&C Toolkit on the following hardware:

- National Instruments NI-CAN hardware Series 1 or 2 with the NI-CAN driver software version 2.3 or later installed.
- National Instruments NI-XNET hardware with the NI-XNET driver software version 1.0 or later installed.
- National Instruments CompactRIO or R Series Multifunction RIO hardware and the NI 9853 or NI 9852 CompactRIO CAN modules.



Note You can use the ECU M&C Toolkit with LabVIEW 2009 or newer on CompactRIO systems or National Instruments R Series Multifunction RIO hardware.

Application Development

This chapter explains how to develop an application using the ECU M&C API.

Choose the Programming Language

The programming language you use for application development determines how to access the ECU M&C Toolkit APIs.

LabVIEW

ECU M&C Toolkit functions and controls are available in the LabVIEW palettes. In LabVIEW, the **ECU M&C Toolkit** palette is located:

- Within the **All Functions** palette for LabVIEW 7.1
- Within the **Addons** palette for LabVIEW 8.0 and 8.1

The reference for each ECU M&C Toolkit API function is in Chapter 5, [ECU M&C API for LabVIEW](#). To access the reference for a function from within LabVIEW, press <Ctrl-H> to open the Help window, click the appropriate ECU M&C function, and then follow the link. The ECU M&C Toolkit software includes a full set of examples for LabVIEW. These examples teach programming basics as well as advanced topics. The example help describes each example and includes a link you can use to open the VI.

LabWindows/CVI

Within LabWindows™/CVI™, the ECU M&C Toolkit function panel is in **Libraries»ECU Measurement and Calibration Toolkit**. Like other LabWindows/CVI function panels, the ECU M&C Toolkit function panel provides help for each function and the ability to generate code. The reference for each API function is located in Chapter 6, [ECU M&C API for C](#). You can access the reference for each function directly from within the function panel. The header file for the ECU M&C Toolkit APIs is `niemc.h`. The library for the ECU M&C Toolkit APIs is `niemcc.lib`.

The toolkit software includes a full set of examples for LabWindows/CVI. The examples are installed in the LabWindows/CVI directory under `samples\ecumc`. Each example provides a complete LabWindows/CVI project (.prj file).

A description of each example is provided in comments at the top of the .c file.

Visual C++ 6

The ECU M&C Toolkit software supports Microsoft Visual C/C++ 6. The header file for Visual C/C++ 6 is in the Program Files\National Instruments\Shared\ExternalCompilerSupport\C\include folder.

To use the ECU M&C API, include the `niemc.h` header file in the code, then link with the `niemcc.lib` library file.

The `niemcc.lib` library file is in the Program Files\National Instruments\Shared\ExternalCompilerSupport\C\lib32\msvc folder.

For C applications (files with a .c extension), include the header file by adding a `#include` to the beginning of the code, like this:

```
#include "niemc.h"
```

For C++ applications (files with a .cpp extension), define `__cplusplus` before including the header, like this:

```
#define __cplusplus  
#include "niemc.h"
```

The `__cplusplus` define enables the transition from C++ to the C language functions.

The reference for each API function is in Chapter 6, [ECU M&C API for C](#).

On Windows Vista (with Standard User Account), the typical path to the C examples folder is `\Users\Public\Documents\National Instruments\ECU Measurement and Calibration Toolkit\Examples\MS Visual C`.

On Windows XP/2000, the typical path to the C examples folder is `\Documents and Settings\All Users\Documents\National Instruments\ECU Measurement and Calibration Toolkit\Examples\MS Visual C`.

Each example is in a separate folder. A description of each example is in comments at the top of the .c file. At the command prompt, after setting MSVC environment variables (such as with MS vcvars32.bat), you can build each example using a command such as:

```
cl /I<HDir> measure.c <LibDir>\niemcc.lib
```

<HDir> is the folder where niemc.h can be found.

<LibDir> is the folder where niemcc.lib can be found.

Other Programming Languages

The ECU M&C Toolkit software does not provide formal support for programming languages other than those described in the preceding sections. If the programming language provides a mechanism to call a Dynamic Link Library (DLL), you can create code to call ECU M&C Toolkit functions. All functions for the ECU M&C API are located in niemcc.dll. If the programming language supports the Microsoft Win32 APIs, you can load pointers to ECU M&C Toolkit functions in the application. The following text demonstrates use of the Win32 functions for C/C++ environments other than Visual C/C++ 6. For more detailed information, refer to Microsoft documentation.

The following C language code fragment illustrates how to call Win32 LoadLibrary to load the DLL for the ECU M&C API:

```
#include <windows.h>
#include "niemc.h"
HINSTANCE NiMcLib = NULL;
NiMcLib = LoadLibrary("niemcc.dll");
```

Next, the application must call the Win32 GetProcAddress function to obtain a pointer to each ECU M&C Toolkit function that the application will use. For each function, you must declare a pointer variable using the prototype of the function. For the prototypes of each ECU M&C Toolkit function, refer to Chapter 6, *ECU M&C API for C*.

Before exiting the application, you must unload the ECU M&C Toolkit DLL as follows:

```
FreeLibrary (NiMcLib);
```

Application Development on CompactRIO or R Series

To run a project on an FPGA target, you need an FPGA bitfile (.lvbitx). The FPGA bitfile is downloaded to the FPGA target on the execution host. A bitfile is a compiled version of an FPGA VI. FPGA VIs, and thus bitfiles, define the CAN, analog, digital, and pulse width modulation (PWM) inputs and outputs of an FPGA target. The ECU M&C Toolkit includes FPGA bitfiles for several FPGA targets. If your target is not included in the examples, you can use the examples as a template and adjust them based on your installed FPGA target.

The default bitfiles are sufficient for a basic ECU M&C application. However, in some situations you may need to modify the existing FPGA code or create a custom bitfile. For example, to use additional I/O on the FPGA target, you must add these I/O to the FPGA VI. You must install the LabVIEW FPGA Module to create these files.

Modify the FPGA VI according to the following guidelines:

- Do not modify, remove, or rename any block diagram controls and indicators named __CAN Rx Data, __CAN Rx Ready, __CAN Tx Data Frame, __CAN Tx Ready, __CAN Bit Timing, __CAN_FPGA Is Running, __CAN Start, __FIFO Full, or __CAN FIFO Empty.
- Do not modify the CAN read and write code except to filter CAN IDs on the receiving side to minimize the amount of CAN data transfers to the host.
- As you create controls or indicators, ensure that each control name is unique within the VI.

Refer to the LabVIEW FPGA Module documentation for more information about creating FPGA VIs and bitfiles for an FPGA target.

Transferring Data between the FPGA and Host Computer

While you are creating or modifying the FPGA VI, it is important to know how the ECU M&C Toolkit transfers CAN data to and from the host computer. The ECU M&C Toolkit transfers data via unique named controls and indicators to transfer data between the host computer and FPGA target.

Customizing the CAN Bridge (FPGA) VI

All examples for CompactRIO or R Series targets are based on the CAN Bridge (FPGA) VI. This VI ensures that the CAN frames are received from the CAN module and transferred to the ECU M&C Toolkit on the host. After the ECU M&C Toolkit has processed the received frame information, a CAN frame response may be transferred to the CAN Bridge (FPGA) VI.

Therefore, changing the code of the CAN receive or transmit part of the CAN Bridge (FPGA) VI may result in communication problems. Be careful when changing this code.

Debugging An Application

The NI-Spy tool monitors function calls to the ECU M&C API, to aid in debugging an application. To launch this tool, open the **Software** branch of the MAX configuration tree, right-click **NI Spy**, and select **Launch NI Spy**.

If you have more than one National Instruments driver installed on your computer, you can specify which APIs you want to monitor at any time. By default, all installed APIs are enabled. To select the APIs to monitor, select **Spy»Options**, select the **View Selections** tab, and select the desired APIs under **Installed API Choices**.

NI-Spy

The NI-Spy tool monitors function calls to the ECU M&C API to aid in the debugging of an application. To launch this tool, open the **Software** branch of the MAX configuration tree, right-click **NI Spy**, and select **Launch NI Spy**.

If you have more than one National Instruments driver installed on your computer, you can specify which APIs you want to monitor at any time. By default, all installed APIs are enabled. To select the APIs to monitor, select **Spy»Options**, select the **View Selections** tab, and select the desired APIs under **Installed API Choices**.

XCP-Spy

The XCP-Spy tool monitors XCP protocol communication to aid in the debugging of an application. Launch this tool from your Start menu in **Start»Programs»National Instruments»ECU Measurement and Calibration Toolkit»XCP Spy**.

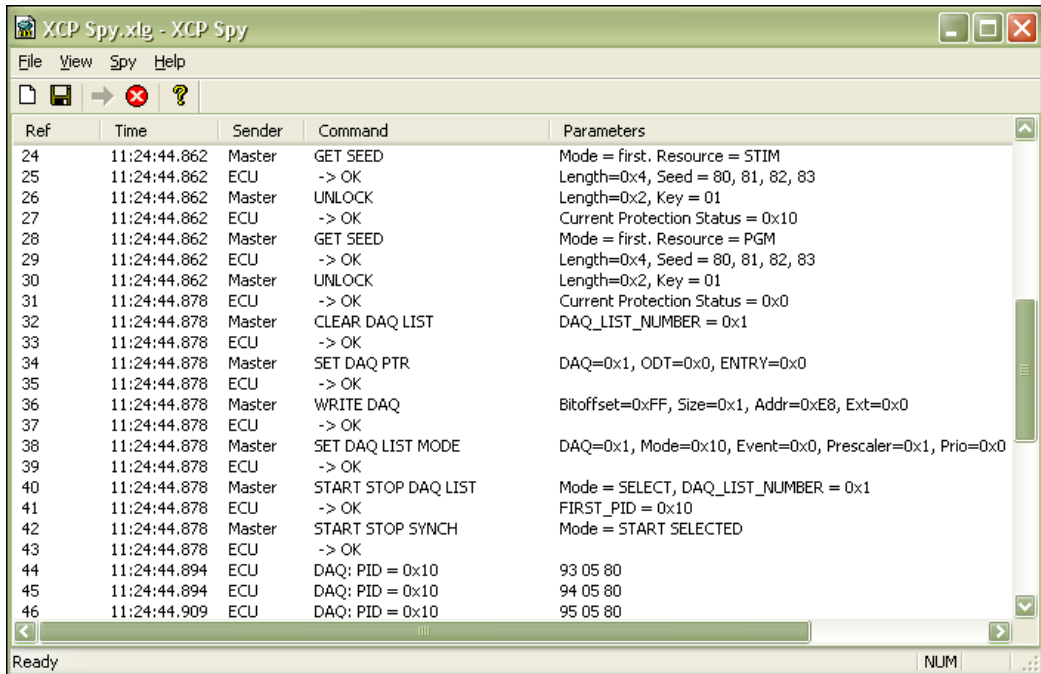

Figure 3-1. XCP Spy

XCP-Spy is an application that monitors, records, and displays XCP communication commands and parameters called by your ECU M&C application using the XCP protocol. Use XCP-Spy to analyze your application's XCP communication and to verify that the communication with your ECU slave is correct.

XCP-Spy may slow down the performance of your application, communication to your ECU slave, and the entire system. You should use XCP-Spy only while you are debugging or when performance is not critical.

For further information on the displayed XCP commands and parameters refer to the *ASAM XCP Part 2 Protocol Layer Specification*.

Saving Captured Communication Data

To save the information displayed in the XCP-Spy capture window, select **File»Save As**. In the dialog box that appears select a name for the capture file. A `.xlg` extension is usually used for saving XCP-Spy capture information. The XCP-Spy log is stored in ASCII format, so you can view the `.xlg` file in any ASCII editor.

Capture Options

To view or modify the XCP-Spy capture options, select **Spy»Options**. By default, XCP-Spy displays 1000 calls in the capture window.

Call History Depth

The Call history depth reflects the maximum number of API calls that XCP-Spy can display. When the number of captured API calls exceeds the Call history depth, only the most recent calls are kept. If your computer runs out of memory, XCP-Spy stops capture and displays a message box indicating it is out of memory.

Capturing Data

By default, capture is activated when you open XCP-Spy. When capture is off the blue arrow (start button) is enabled. When capture is on the red X (stop button) is enabled. To turn capture on, click on the blue arrow button on the toolbar. To turn capture off, click on the red button on the toolbar.

Selecting Which XCP Commands to View

You can specify which XCP command you want to spy on at any time. By default all XCP commands are enabled. To select/deselect the XCP commands to spy on, select **Spy»Options**, then select the commands under **Capture**.

XCP Commands—Captures all XCP commands

DAQ Messages—Captures all DAQ list commands (ECU measurement commands)

STIM Messages—Captures all STIM list (ECU slave stimulation commands)

Using the ECU M&C API

This chapter helps you get started with the ECU M&C API.

Structure of the ECU M&C API

The ECU M&C API is divided into three main function categories, the high-level Channel-based functions, and the generic low-level CCP and XCP functions. The ECU M&C Channel functions provide an easy way to access ECU internal data through named channels. The ECU M&C CCP functions provide direct access to the CCP commands on a very low programming level. The ECU M&C XCP functions provide direct access to the XCP commands on a very low programming level. Figure 4-1 outlines the three function categories.

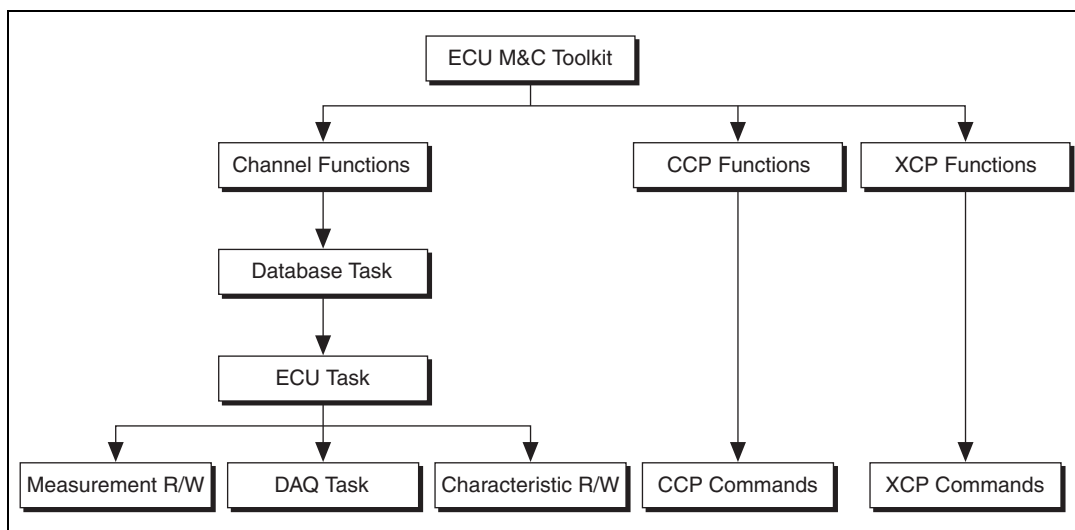

Figure 4-1. ECU Architectural Overview

ECU M&C Channel Functions

With the ECU M&C Channel functions there are a number of ways to access memory content in an ECU. The starting point is always the creation of a database task, which is the link to a valid ASAM MCD 2MC database file (*.A2L file), and the selection of the protocol (CCP or XCP). With the database task reference it is possible to create an ECU task reference, which links to the selected ECU. Depending on the application scenario, the ECU task reference can be used for the following:

- Creation of a Measurement task to measure ECU internal data continuously or on demand
- Direct read/write of 0- to 2-dimensional Characteristics
- Read/write of single Measurement values on demand

What is an ECU Measurement?

An ECU Measurement, called *ECU Data Acquisition (DAQ)* in the CCP and XCP specifications, is a definition of specific procedures and CAN messages sent from the slave device (ECU) to the master device for fast data acquisition (DAQ).

The XCP protocol supports synchronous data transfer in both directions, from Master to Slave (DAQ list) and from Slave to Master (STIM list). XCP allows several DAQ lists, which may be simultaneously active. The sampling and transfer of each DAQ list is triggered by individual events in the slave. To allow reduction of the transfer rate, a transfer rate prescaler may be applied to the DAQ lists.

What is an ECU Characteristic?

An ECU Characteristic represents an ECU internal memory range with defined access methods through the CCP protocol. The memory range of a single Characteristic can be structured in three ways:

- 0-dimensional—a single value
- 1-dimensional—a curve of values
- 2-dimensional—a field of values

A Characteristic may be defined as read-only or read and write accessible.

ECU M&C CCP and XCP Functions

The ECU M&C Channel functions do not expose the method used for ECU memory access. However, some applications may need specific CCP or XCP command sequences, or custom designed commands, which are not supported by the CCP or XCP protocols. For these applications, the ECU M&C CCP functions and the ECU M&C XCP functions provide access to the ECU information at a very low level.

Basic Programming Model

The flowchart in Figure 4-2 illustrates the process to initiate communication to an ECU with the ECU M&C Channel functions. A description of each step in the decision process follows the flowchart.

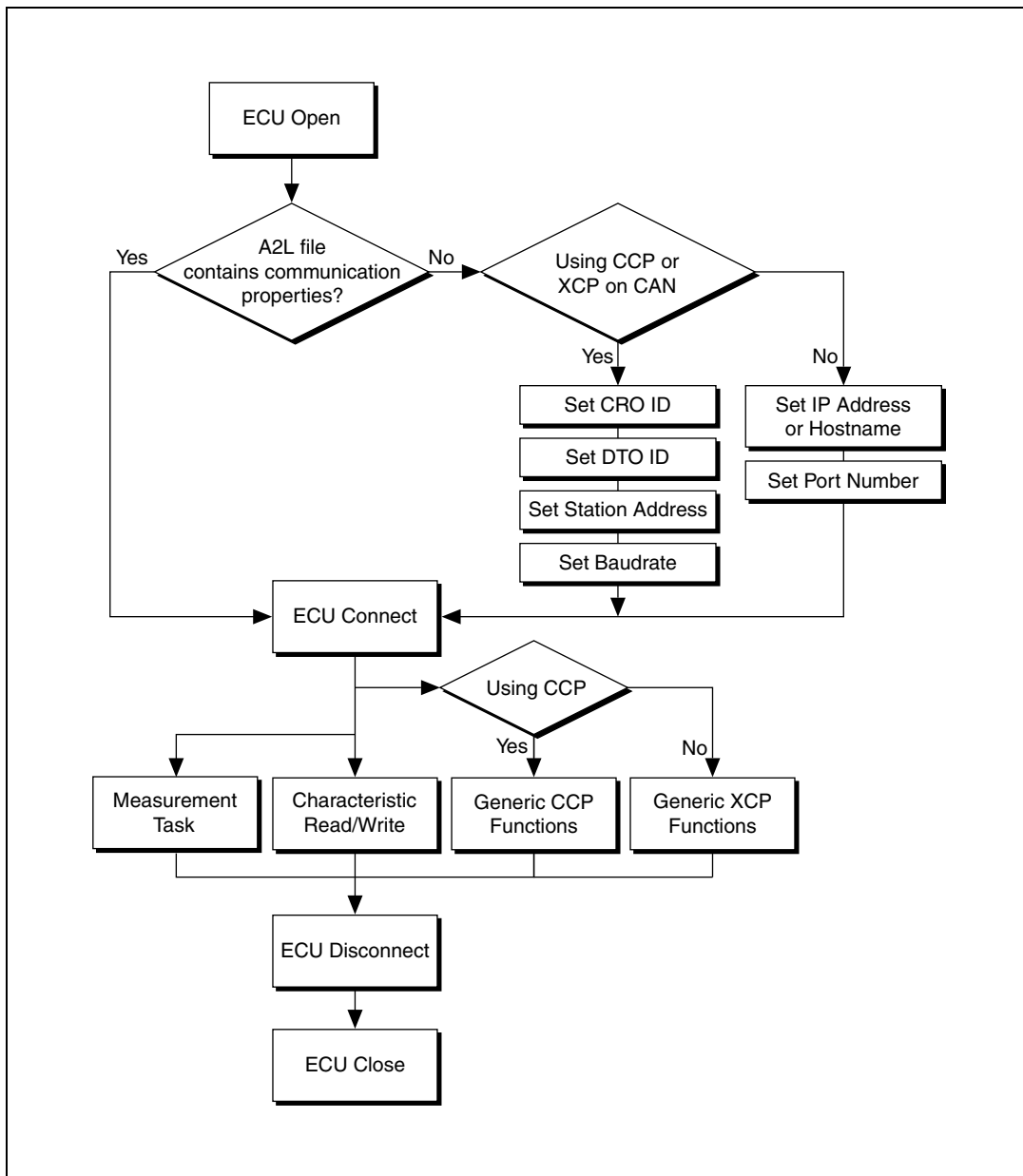

Figure 4-2. ECU Communication Decision Chart

ECU Open

The **ECU Open** function combines the opening of a selected ASAM MCD 2MC database file with the .A2L file extension and the selection of a stored ECU name. The required parameters are the ASAM MCD 2MC database path and filename, and the dedicated CAN interface if you are using CCP or XCP with CAN. The CAN interface is used for communication with the ECU. If you are using XCP with UDP or TCP, a port number and IP address or hostname must be defined in the A2L database.

The function to open and select an ECU is **MC ECU Open.vi** in LabVIEW or `mcDatabaseOpen` followed by `mcECUSelectEx` in C.



Note The import of ASAM MCD 2MC database files into MAX is not supported.

ASAM MCD 2MC Communication Properties for CCP or XCP with CAN

If your ASAM MCD 2MC database file already contains communication properties, you can directly open the communication to your selected ECU.

If the communication properties are not stored in the ASAM MCD 2MC file, the communication properties must be manually set. To establish communication through CCP or XCP with CAN, the target ECU slave should be addressed by setting the following properties.

CRO ID

The **CRO ID** (**C**ommand **R**eceive **O**bject) is used to send commands and data from the host to the slave device.

DTO ID

The **DTO ID** (**D**ata **T**ransmission **O**bject) is used by the ECU to respond to CCP commands, and to send data and status information to the CCP master.

Station Address

CCP is based on the idea that several ECUs can share the same CAN Arbitration IDs for CCP communication. To avoid communication conflicts, CCP defines a **Station Address** that must be unique for all ECUs sharing the same CAN Arbitration IDs. Unless an ECU has been addressed by its **Station Address**, the ECU must not react to CCP commands sent by the CCP master.

Baudrate

The **baudrate** property may be missing in an A2L database file and can be set explicitly within the application. This property provides the baud rate at which communication will occur, and applies to all tasks initialized with the interface. You can specify one of the predefined baud rates, or specify advanced baud rates which refer to the settings of the Bit Timing Register 0 (BTR0) and 1 (BTR1). For more information, refer to the **Interface Properties** dialog in MAX, or the *NI-CAN Hardware and Software Manual*. The baud rate is originally set within MAX.

ASAM MCD 2MC Communication Properties for XCP with UDP or TCP

If the XCP communication properties are not stored in the ASAM MCD 2MC file, the communication properties must be manually set. To establish communication through XCP with UDP or TCP the target ECU slave should be addressed by setting the following properties.

IP Address or hostname

The *IP address* refers to the identifier for a computer or device on a TCP/IP network. Networks using the TCP/IP protocol route messages based on the IP address of the destination.

A *hostname* describes the unique name by which a device is known on a network. Hostnames are used by various naming systems: NIS, DNS, SMB, etc. Hostnames are high-level aliases which ultimately correlate to unique network hardware MAC addresses.

Port number

In TCP/IP and UDP networks, a port is an end-point to a logical connection through which a client program specifies a server program on a computer in a network. Port numbers range from 0 to 65536, but only port numbers 0 to 1024 are reserved for privileged services and designated as well-known ports.

ECU Connect

The **ECU Connect** function establishes communication to the selected ECU through CCP using the CCP CONNECT command or through XCP using the CONNECT command. It establishes a logical connection to an ECU. Unless a slave device (ECU) is unconnected, it must not execute or respond to any command sent by the application. The only exception to this

rule is the Test command, in which case the slave with the specified address may acknowledge the command. Only a single slave can be connected to the application at a time. After a successful **ECU Connect** you can create a Measurement Task or read/write a Characteristic.

The function to open and select an ECU is **MC ECU Connect.vi** in LabVIEW and `mcECUConnect` in C.

ECU Disconnect

The **ECU Disconnect** function permanently disconnects the specified slave and ends the measurement and calibration session. When the measurement and calibration session is terminated, all DAQ lists for the device are stopped and cleared, and the protection masks of the device are set to their default values.

The function to disconnect an ECU is **MC ECU Disconnect.vi** in LabVIEW or `mcECUDisconnect` in C.

ECU Close

The **MC ECU Close** function deselects the ECU and closes the remaining database reference handle. **MC ECU Close** must always be the final ECU M&C function call. If you do not use **MC ECU Close**, the remaining task configurations can cause problems in the execution of subsequent ECU M&C applications.

The function to close an ECU is **MC ECU Close.vi** in LabVIEW. To deselect the ECU and close the database reference handle in C, call the function `mcECUDeselect` followed by `mcDatabaseClose`.

Characteristic Read and Write

Access Characteristics

To access the Characteristics of an ECU you must select and connect to the specified ECU through the procedure given above. The function to open and select an ECU is **MC ECU Open.vi** in LabVIEW, or `mcDatabaseOpen` followed by `mcECUSelectEx` in C. Once the ECU has been connected an ECU Reference handle (**ECU ref out** in LabVIEW, `ECUrefNum` in C) must be acquired before any additional actions can be performed.

Characteristic Read

The application must call the **Read Characteristic** function to obtain scaled floating point samples. The application typically calls **Read Characteristic** on demand. Calling **Read Characteristic** in a loop can cause significant CAN network traffic, as Characteristics may contain large amounts of data.

The function to read 0- to 2-dimensional Characteristics is [MC Characteristic Read.vi](#) in LabVIEW or [mcCharacteristicRead](#) in C. The function to read single double values as Characteristics is [MC Characteristic Read Single Value.vi](#) in LabVIEW or [mcCharacteristicReadSingleValue](#) in C.

Before reading a Characteristic, it may be helpful to verify the dimension of the Characteristic based on the definition in the ASAM MCD 2MC database file. Depending on the dimension of the Characteristic, use the appropriate **Read** function for reading a double, a 1D array of doubles, or a 2D array of doubles.

The function to verify a dimension of a named Characteristic is [MC Get Property.vi](#) with the parameter **Characteristic/Dimension** in LabVIEW or [mcGetProperty](#) with the parameter `mcPropChar_Dimension` in C.

Characteristic Write

The application must call the **Write Characteristic** function to output scaled floating-point samples. The application typically calls **Write Characteristic** on demand. Calling **Write Characteristic** in a loop can cause significant network traffic, as Characteristics may contain large amounts of data.

The function to write a Characteristic is [MC Characteristic Write.vi](#) in LabVIEW or [mcCharacteristicWrite](#) in C.

Before writing a Characteristic, it may be helpful to verify the dimension of the Characteristic based on the definition in the ASAM MCD 2MC database file. Depending on the dimension of the Characteristic, use the appropriate **Write** function for writing a double, a 1D array of doubles, or a 2D array of doubles.

The function to verify a dimension of a named Characteristic is [MC Get Property.vi](#) with the parameter **Characteristic/Dimension** in LabVIEW or [mcGetProperty](#) with the parameter `mcPropChar_Dimension` in C.

Measurement Task

To create a Measurement task you need to select available Measurement signals from an ASAM MCD 2MC database file. Create a valid ECU Reference handle as described in the [Access Characteristics](#) section.

The flowchart in Figure 4-3 shows the process to perform an ECU Measurement task. A description of each step in the decision process follows the flowchart.

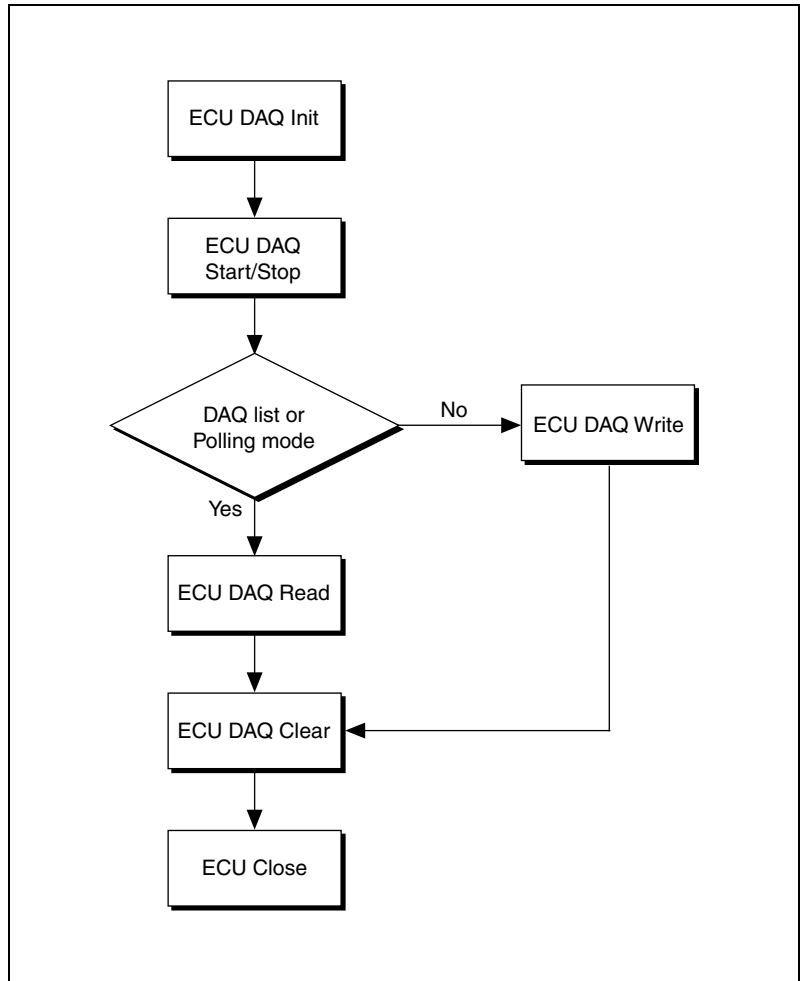

Figure 4-3. ECU Measurement Setup Flowchart

DAQ Initialize

The **DAQ Initialize** function initializes a list of Measurement channels as a single Measurement task. The communication for that Measurement task is started by the first **DAQ Read** function. The **DAQ Initialize** function is **MC DAQ Initialize.vi** in LabVIEW or `mcDAQInitialize` in other languages.

The **DAQ Initialize** function uses the following input parameters:

Measurement list

Specifies the list of channels for the task with one string for each channel.

ECU Reference handle

Typically, the **ECU Reference handle** is created by opening the ASAM MCD 2MC database using the **ECU Open** function, then connecting to an ECU using the **ECU Connect** function.

Mode

Specifies the input mode to use for the task. This determines the data transfer for the task (Polling, DAQ list, or STIM list).

SampleRate

Specifies the sampling rate for a specific DAQ list or STIM list. The sample rate is specified in Hertz (samples per second). For more information, refer to the *DAQ Read* section.

DTO ID

If you are using the CCP protocol, the **DTO ID (Data Transmission Object)** is used by the ECU to respond to CCP commands, and to send data and status information to the CCP master.

DAQ Start Stop

The optional function **DAQ Start Stop** starts or stops the transmission of the DAQ lists for an ECU M&C Measurement task. If you do not specify **MC DAQ Start Stop.vi** before your first **DAQ Read** or **DAQ Write** function, **MC DAQ Start Stop.vi** is implicitly performed by the first **DAQ Read** or **DAQ Write** call. After you start the transmission of the DAQ lists or STIM lists, you can no longer change the configuration of the Measurement task with **Set Property**. **MC DAQ Start Stop.vi** is implicitly performed by **DAQ Clear** to stop transmission of the DAQ lists.

The function to start a DAQ list is **MC DAQ Start Stop.vi** in LabVIEW or `mcDAQStartStop` in C.

DAQ Read

The application must call the **DAQ Read** function to obtain floating-point samples. The application typically calls **DAQ Read** in a loop until done. The **Read** function is **MC DAQ Read.vi** in LabVIEW (all types that do not end in **Time & Dbt**) or `mcDAQRead` in other languages.

The behavior of **Read** depends on the initialized sample rate and the selected mode.

sample rate = 0

DAQ Read returns a single sample from the most recent message(s) received from the network. One sample is returned for every channel in the **DAQ Initialize** list.

Figure 4-4 shows an example of **DAQ Read** with a sample rate = 0. *A*, *B*, and *C* represent messages for the initialized channels. *def* represents the default value 0. If no message is received after the start of the application, the default value 0 is returned along with a warning.

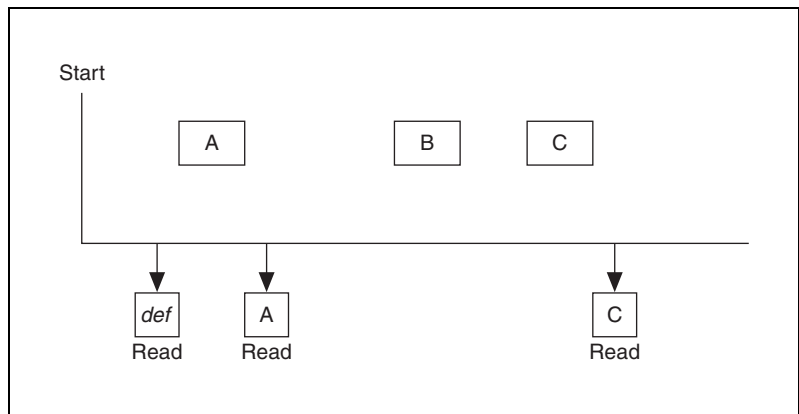

Figure 4-4. Example of Read With Sample Rate = 0

sample rate > 0

DAQ Read returns an array of samples for every channel in the **DAQ Initialize** list. Each time the clock ticks at the specified rate, a sample from the most recent message(s) is inserted into the arrays. In other words, the samples are repeated in the array at the specified rate until a new message is received. By using the same sample rate with NI-DAQ Analog Input channels or NI-DAQmx Analog Input channels, you can compare ECU DAQ and NI-DAQ/NI-DAQmx samples over time.

Figure 4-5 shows an example of **DAQ Read** with a sample rate > 0. *A*, *B*, and *C* represent messages for the initialized channels. Δt represents the time between samples as specified by the sample rate. *def* represents the default value 0.

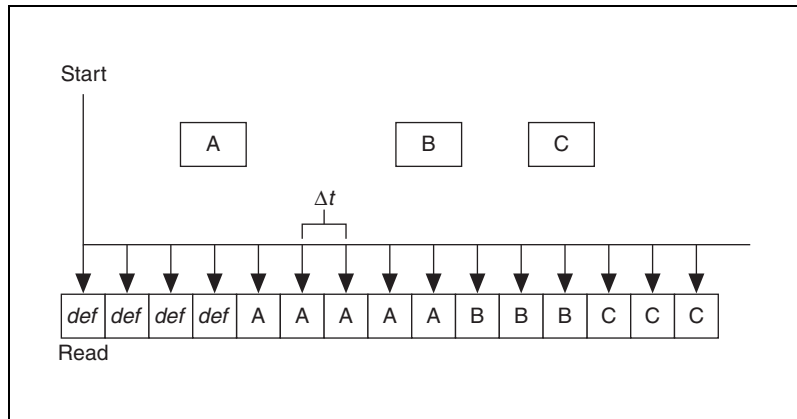

Figure 4-5. Example of Read With Sample Rate > 0

DAQ Write

If you are using XCP and the DAQ initialize mode is set to **STIM list** the application must call the **DAQ Write** function to output floating-point samples. The application typically calls **DAQ Write** in a loop until done. The **DAQ Write** function is [MC DAQ Write.vi](#) in LabVIEW or [mcDAQWrite](#) in other languages.

DAQ Clear

DAQ Clear must always be the final function called for a specific Measurement task. If you do not use **DAQ Clear**, the remaining Measurement task configuration can cause problems in the execution of subsequent ECU M&C applications. Because this function clears the Measurement task, the Measurement task reference is transferred into an ECU reference task handle. To change the properties of a running Measurement task, use **DAQ Start Stop** to stop the task, **Set Property** to change the desired DAQ property, then **DAQ Start Stop** to restart the Measurement task again.

The function to clear a DAQ list is **MC DAQ Clear.vi** in LabVIEW or `mcDAQClear` in C.

Memory Programming

The ECU Measurement and Calibration Toolkit allows you to issue a memory programming sequence for your ECU after you create an ECU Reference handle as described in the *Basic Programming Model* section.

The flowchart in Figure 4-6 illustrates the general process of a memory programming sequence of an ECU with the ECU M&C functions. A description of each step in the decision process follows the flowchart.

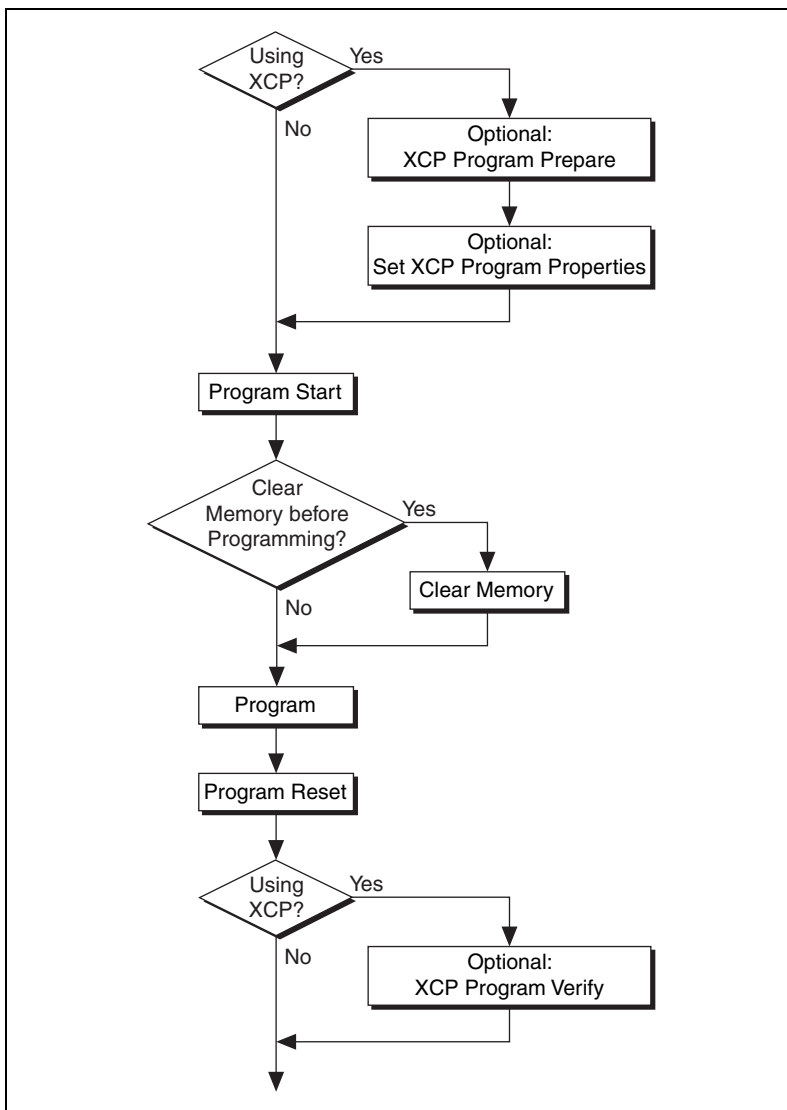

Figure 4-6. Memory Programming Process Decision Chart

Program Start

The **Program Start** function sets the ECU into the memory programming mode. Note that in this mode specific features might be restricted, for instance, the ECU might refuse to change into the programming mode while a DAQ list is running. The **Program Start** function is **MC Program Start.vi** in LabVIEW and **mcProgramStart** in other languages.

Clear Memory

It might be necessary to clear the memory before it is reprogrammed. The details are ECU-dependent. The **Clear Memory** function performs the memory clearing operation. It is **MC Clear Memory.vi** in LabVIEW or `mcClearMemory` in other languages.

Program

The **Program** function actually downloads the new code to the ECU. It is **MC Program.vi** in LabVIEW or `mcProgram` in other languages.

Program Reset

The Program Reset function terminates a programming sequence. Note that for the XCP protocol, **Program Reset** performs a hardware reset of the ECU and causes a disconnect. You have to reconnect to the ECU using the **ECU Connect** function to perform further operations. The **Program Reset** function is **MC Program Reset.vi** in LabVIEW and `mcProgramReset` in other languages.

Optional Steps for the XCP Protocol

XCP Program Prepare

An ECU using the XCP protocol might require an XCP PROGRAM_PREPARE command before a programming sequence is started. This command can be issued with the **XCP Program Prepare** function. It is **MC XCP Program Prepare.vi** in LabVIEW and `mcXCPProgramPrepare` in other languages.

Set XCP Programming Properties

XCP allows the programming process to be controlled by several variables. These are the **Compression Method**, **Encryption Method**, **Programming Method**, and **Access Method** properties. They default to 0, but can be set to any value before the programming process starts. The allowed values for these properties are ECU-specific. If any of these properties is set to a nonzero value, an appropriate PROGRAM_FORMAT XCP command is issued before the programming takes place. Note that the **Access Method** property also affects the **Clear Memory** function.

XCP Program Verify

After the memory programming XCP allows to verify whether the operation was successful by the PROGRAM_VERIFY XCP command. The details of this command are highly ECU-specific. This command can be issued using the **XCP Program Verify** function. It is **MC XCP Program Verify.vi** in LabVIEW and `mcXCProgramVerify` in other languages.

Additional Programming Topics

The following sections provide information you can use to extend the basic programming model.

Get Names

If you are developing an application that another person will use, you may not want to specify a fixed channel list for a Measurement task or a fixed channel for a Characteristic in the application. Ideally, you want the end-user to select the channels of interest from user interface controls such as list boxes. The **Get Names** function queries an ASAM MCD 2MC database and returns a list of all channels in that database regarding the selected query mode. You can use this list to populate user-interface controls. The user can then select channels from these controls, avoiding the need to type in each name. Once the user makes the selections, the application can pass the resulting list to the appropriate function, such as **DAQ Initialize**, for an ECU Measurement channel list. The **Get Names** function is **MC Get Names.vi** in LabVIEW or `mcGetNames` in C.

Set/Get Properties

If you need to change particular parameters within an application, such as the **DTO ID**, use the following sequence:

1. Initialize the Measurement task as stopped. The **Initialize** function is **MC DAQ Initialize.vi** in LabVIEW or `mcDAQInitialize` in C.
2. Use **Set Property** to specify the new value for the **DTO_ID** property. The **Set Property** function is **MC Set Property.vi** in LabVIEW or `mcSetProperty` in C.
3. Start the Measurement task with the **DAQ Start Stop** function. The **DAQ Start Stop** function is **MC DAQ Start Stop.vi** in LabVIEW or `mcDAQStartStop` in C. You can also start the Measurement task implicitly by issuing **DAQ Read**.

After the task is started you may need to change properties again. To change properties within the application, use the **DAQ Start Stop** function to stop the Measurement task, **Set Property** to change properties, then start the task again.

You also can use the **Get Property** function to get the value of any property. The **Get Property** function returns values whether the task is running or not. The **Get Property** function is **MC Get Property.vi** in LabVIEW or `mcGetProperty` in C.

Generic CCP Functions

The generic ECU M&C CCP functions provide direct access to the CCP commands on a very low programming level. For further information for the use and parameters of the CCP commands, refer to the *CAN Calibration Protocol Specification, Version 2.1*. Table 4-1 provides an overview of the CCP commands and their corresponding LabVIEW VIs or C functions.

Table 4-1. Overview of the CCP Commands with Related VIs and C Functions

CCP Command	LabVIEW VI Name	C Function Name
ACTION_SERVICE	MC CCP Action Service.vi	<code>mcCCPActionService</code>
BUILD_CHKSUM	MC Build Checksum.vi	<code>mcBuildChecksum</code>
CLEAR_MEMORY	MC Clear Memory.vi	<code>mcClearMemory</code>
DIAG_SERVICE	MC CCP Diag Service.vi	<code>mcCCPDiagService</code>
DNLOAD	MC Download.vi	<code>mcDownload</code>
GET_ACTIVE_CAL_PAGE	MC CCP Get Active Cal Page.vi	<code>mcCCPGetActiveCalPage</code>
GET_CCP_VERSION	MC CCP Get Version.vi	<code>mcCCPGetVersion</code>
GET_S_STATUS	MC CCP Get Session Status.vi	<code>mcCCPGetSessionStatus</code>
MOVE	MC CCP Move Memory.vi	<code>mcCCPMoveMemory</code>
PROGRAM	MC Program.vi	<code>mcProgram</code>
SELECT_CAL_PAGE	MC CCP Select Cal Page.vi	<code>mcCCPSelectCalPage</code>

Table 4-1. Overview of the CCP Commands with Related VIs and C Functions (Continued)

CCP Command	LabVIEW VI Name	C Function Name
SET_S_STATUS	MC CCP Set Session Status.vi	mcCCPSetSessionStatus
UPLOAD	MC Upload.vi	mcUpload

Generic XCP Functions

The generic ECU M&C XCP functions provide direct access to the XCP commands on a very low programming level. For more information about the use and parameters of the XCP commands, refer to the ASAM *XCP Part 2 Protocol Layer Specification*. Table 4-2 provides an overview of the XCP commands with their corresponding LabVIEW VIs or C functions.

Table 4-2. Overview of the XCP Commands with Related VIs and C Functions

XCP Command	LabVIEW VI Name	C Function Name
BUILD_CHKSUM	MC Build Checksum.vi	mcBuildChecksum
CLEAR_MEMORY	MC Clear Memory.vi	mcClearMemory
COPY_CAL_PAGE	MC XCP Copy Cal Page.vi	mcXCPCopyCalPage
DOWNLOAD	MC Download.vi	mcDownload
GET_CAL_PAGE	MC XCP Get Cal Page.vi	mcCCPGetActiveCalPage
GET_ID	MC XCP Get ID.vi	mcXCPGetID
GET_STATUS	MC XCP Get Status.vi	mcXCPGetStatus
PROGRAM	MC Program.vi	mcProgram
PROGRAM_PREPARE	MC XCP Program Prepare.vi	mcXCPProgramPrepare
PROGRAM_RESET	MC Program Reset.vi	mcProgramReset
PROGRAM_START	MC Program Start.vi	mcProgramStart
PROGRAM_VERIFY	MC XCP Program Verify.vi	mcXCPProgramVerify
SET_CAL_PAGE	MC XCP Set Cal Page.vi	mcXCPSetCalPage
SET_REQUEST	MC XCP Set Request.vi	mcXCPSetRequest

Table 4-2. Overview of the XCP Commands with Related VIs and C Functions (Continued)

XCP Command	LabVIEW VI Name	C Function Name
SET_SEGMENT_MODE	MC XCP Set Segment Mode.vi	mcXCPSetSegmentMode
UPLOAD	MC Upload.vi	mcUpload

Seed and Key Algorithm

To restrict access to an ECU, you can add a defined login mechanism to ECU software. The Association for Standardization of Automation and Measuring Systems (ASAM) defines this seed, which may be stored in the A2L file. A typical login mechanism may happen as follows:

1. Connect to the ECU.
2. Exchange station identifications.
3. Get the seed for the key.
4. Calculate the key using a seed and key DLL as ASAM defines.
5. Unlock the ECU protection by sending the calculated key.

ASAM AE Common defines the seed and key algorithm in the *Seed and Key and Checksum Calculation API Version 1.0*. The specification defines the Win32 APIs for seed and key calculation and checksum calculation.

Definition for Seed and Key Algorithm

Function name: ASAP1A_CCP_ComputeKeyFromSeed

Parameter	Description
1	Pointer to the seed data, retrieved from the ECU GET_SEED command.
2	Seed data size in number of bytes.
3	Pointer to key data, returning the calculated.
4	Key data size in number of bytes.
5	Key data size in number of bytes.

The calling convention is as defined in the *WIN32 API Specification for ASAP1b*, section 2.4.

Seed and Key Example

The following example shows a possible header file for a library for key calculation.

```

/*
// Header file for ASAP1a CCP V2.1 Seed and Key Algorithm
*/
#ifndef _SEEDKEY_H_
#define _SEEDKEY_H_
#ifndef DllImport
#define DllImport __declspec( dllimport )
#endif
#ifndef DllExport
#define DllExport __declspec( dllexport )
#endif
#ifdef SEEDKEYAPI_IMPL // only defined by implementor of SeedKeyApi
#define SEEDKEYAPI DllExport __cdecl
#else
#define SEEDKEYAPI DllImport __cdecl
#endif
#ifdef __cplusplus
extern "C" {
#endif

BOOL SEEDKEYAPI ASAP1A_CCP_ComputeKeyFromSeed (BYTE *Seed,
unsigned short SizeSeed, BYTE *Key, unsigned short MaxSizeKey,
unsigned short *SizeKey);
// Seed: Pointer to seed data
// SizeSeed: Size of seed data (length of "Seed")
// Key: Pointer, where DLL should insert the calculated key data.
// MaxSizeKey: Maximum size of "Key".
// SizeKey: Should be set from DLL corresponding to the number of data
// inserted to "Key" (at most "MaxSizeKey")
// Result: The value FALSE (= 0) indicates that the key could not be
// calculated from seed data (for example, "MaxSizeKey" is too small).
// TRUE (!= 0) indicates success of key calculation.
#ifdef __cplusplus
}
#endif
#endif // _SEEDKEY_H_

```

Checksum Algorithm

ASAM proposed a WIN32 API function to have a common interface to implement the checksum algorithms for verifying ECU calibration and program data. For details, refer to the *ASAM Seed and Key and Checksum Calculation API Version 1.0*.

Definition for a Checksum Algorithm

Function name: `BOOL CalcChecksum(struct TRange *ptr, int nRanges, BYTE *pnChecksum, int *pnSignificant, WORD nFlags)`

Parameter	Description
1	Pointer to an array of ranges, stored in structures of type <code>TRange</code> .
2	Number of ranges stored in the array that parameter 1 points to.
3	Pointer to a byte array where the checksum must be stored. The DLL writes a maximum of 8 bytes, so the caller should reserve space for 8 bytes of data.
4	Length of actually calculated checksum (1...8).
5	Flag field for commanding how the algorithm works. Currently, only bit 0 is defined: Bit 0 = 0: <code>pnChecksum</code> receives the algorithm checksum calculation result. Bit 0 = 1: <code>pnChecksum</code> points to a checksum that is compared within the DLL with the checksum that the algorithm calculates. Returns <code>TRUE</code> if the checksums are identical, <code>FALSE</code> otherwise. All other bits are reserved and should be set to 0.

`TRange` is defined as follows:

```
struct TRange
{
char *pMem;
unsigned long lLen;
}
```

The calling convention is as defined in the *WIN32 API Specification for ASAPIb*, chapter 2.4.

Checksum Algorithm Example

The following example shows a possible header file for a library for checksum calculation.

```

/*
// checksum.h
// Header file for Checksum Algorithm
*/
#ifndef _CHECKSUM_H
#define _CHECKSUM_H
#ifdef __cplusplus
extern "C" {
#endif
#ifndef DllImport
#define DllImport __declspec( dllimport )
#endif
#ifndef DllExport
#define DllExport __declspec( dllexport )
#endif
#ifdef CHECKSUMAPI_IMPL // only defined by implementor of ChecksumApi
#define CHECKSUMAPI DllExport __cdecl
#else
#define CHECKSUMAPI DllImport __cdecl
#endif
struct TRange
{
char *pMem;
unsigned long lLen;
};
#ifdef __cplusplus
extern "C" {
#endif
BOOL CHECKSUMAPI CalcChecksum(struct TRange *ptr,
int nRanges,
BYTE *pnChecksum,
int *pnSignificant,
WORD nFlags);
#ifdef __cplusplus
}
#endif
#endif // _CHECKSUM_H

```

Seed and Key and Checksum Algorithms for VxWorks Targets

LabVIEW RT users can run the ECU Measurement and Calibration Toolkit on either a LabVIEW RT target such as a PXI controller or an Intel-based CompactRIO running the Pharlap operating system, which supports Win32 calls, or on a PowerPC-based CompactRIO controller running a Windriver VxWorks operating system.

If you are using a CompactRIO target with a PowerPC controller running a VxWorks operating system, you cannot use any Win32 function calls based on a DLL. However, the GNU tool chain distributed with VxWorks can compile shared libraries for controllers running Wind River VxWorks, including the CompactRIO 901x and 907x series. You can access the shared libraries (*.OUT modules) for VxWorks through the ECU Measurement and Calibration Toolkit by using a C/C++ function definition that is slightly different from the ASAM specification, due to the differences between Win32 DLLs and VxWorks OUT modules.

You can obtain the GNU tool chain for VxWorks by either purchasing a VxWorks development license from Wind River or downloading the redistributable GNU tool chain from ni.com. If you purchase VxWorks, you can use the Wind River Workbench IDE, featuring source code-level debugging and build management. The redistributable GNU tool chain downloadable on ni.com offers debugging only at the assembly code level, and you must use the included GNU Make to build binaries.



Note LabVIEW 2009 RT installs version 6.3 of the VxWorks OS to compatible targets. All builds should be targeted to corresponding versions and use corresponding header files. As new versions of LabVIEW RT become available, different versions of VxWorks may be installed and may require you to rebuild your libraries. Refer to the readme file for LabVIEW RT to find the corresponding VxWorks OS version.

Example of a Header for a Seed and Key and Checksum Algorithm for a VxWorks Target

The module name of the compiled out file must correspond to the seed and key and checksum function name defined in the ASAM A2L database.

The following example uses the seed and key module name `ccpecu.out`. Therefore, the seed and key function is named `ccpecu_ASAP1A_CCP_ComputeKeyFromSeed`. The example uses the prefix in addition to the ASAM standard, because the VxWorks OS requires unique function names across all loaded modules. Therefore, multiple

modules must not export functions with the same names. To support multiple ECUs with the ECU Measurement and Calibration Toolkit, each seed and key and checksum function must have a unique name. To achieve unique function names for the seed and key and checksum functions, these functions have the module name (in lower case) followed by an underline as a prefix.

The following example shows a possible header file for a module used for seed and key and checksum calculation under VxWorks targets.

```
#ifndef __CCPECU_h__
#define __CCPECU_h__

/// \brief defines the name of the Seed-Key function
///
/// Here the name of the seed key function is defined.
/// The name of the seed key function is the name of the module in lower case
/// letters followed by an underscore and the function name
/// "ASAP1A_CCP_ComputeKeyFromSeed".
/// \todo replace the prefix "ccpecu_" by the name of your module in lower
/// case letters.
#define SEED_KEY_NAME ccpecu_ASAP1A_CCP_ComputeKeyFromSeed

/// \brief defines the name of the Checksum function
///
/// Here the name of the Checksum function is defined.
/// The name of the Checksum function is the name of the module in lower case
/// letters followed by an underscore and the function name
/// "CalcChecksum".
/// \todo replace the prefix "ccpecu_" by the name of your module in lower
/// case letters.
#define CALC_CHECKSUM_NAME ccpecu_CalcChecksum

struct TRange
{
    char          *pMem;
    unsigned long  lLen;
};

#ifdef __cplusplus
extern "C" {
#endif
```

```

/// \brief Function to calculate a key from a given seed to
/// unlock an ECU resource.
///
/// This function calculates a key from a given seed so that you are
/// able to unlock the access to an ECU resource. The seed is generated
/// by the ECU and needs to be queried before you can unlock an ECU resource.
bool SEED_KEY_NAME(
    unsigned char    *Seed,          ///< Seed provided by the ECU
    unsigned short   SizeSeed,      ///< Size of the seed provided by the ECU
    unsigned char    *Key,          ///< Pointer to a buffer to return the key
    unsigned short   MaxSizeKey,    ///< Size of the buffer provided to
                                   ///< return the key
    unsigned short   *SizeKey       ///< returns the size of the calculated key
)
__attribute__((section(".export")));

/// \brief Function to calculate a checksum over a given memory range.
///
/// This function calculates a checksum over a given memory range. The
/// function is used, for example, to verify data after a download or
/// programming action.
bool CALC_CHECKSUM_NAME (
    struct TRange    *ptr,          ///< Description of the memory area
                                   ///< to be checked
    int              nRanges,      ///< Number of memory blocks to be checked
    unsigned char    *pnCheckSum,  ///< Pointer to a buffer to return
                                   ///< the checksum
    int              *pnSignificant, ///< Size of the buffer to
                                   ///< return the checksum
    unsigned short   nFlags        ///< flags for calculating the checksum
)
__attribute__((section(".export")));
#ifdef __cplusplus
}
#endif

#endif // __CCPECU_h__

```

ECU M&C API for LabVIEW

This chapter lists the LabVIEW VIs for the ECU M&C API and describes the format, purpose, and parameters for each VI. The VIs in this chapter are listed alphabetically. Unless otherwise stated, each VI suspends execution of the calling thread until it completes.

Section Headings

The following are section headings found in the ECU M&C API for LabVIEW VIs.

Purpose

Each VI description includes a brief statement of the purpose of the VI.

Format

The format section describes the format of each VI.

Input and Output

The input and output parameters for each VI are listed.

Description

The description section gives details about the purpose and effect of each VI.

List of VIs

The following table is an alphabetical list of the ECU M&C Toolkit VIs.

Table 5-1. ECU M&C API VIs for LabVIEW

Function	Purpose
MC Build Checksum.vi	Calculates a checksum over a defined memory range within the ECU.
MC Calc Checksum.vi	Calculates the checksum of a data block in memory.
MC CCP Action Service.vi	Calls an implementation-specific action service on the ECU.

Table 5-1. ECU M&C API VIs for LabVIEW (Continued)

Function	Purpose
MC CCP Diag Service.vi	Calls a diagnostic service on the ECU.
MC CCP Get Active Cal Page.vi	Retrieves the ECU Memory Transfer Address pointer to the calibration data page.
MC CCP Get Result.vi	Uploads requested data.
MC CCP Get Session Status.vi	Retrieves the current calibration status of the ECU.
MC CCP Get Version.vi	Retrieves the version of the CCP implemented in the ECU.
MC CCP Move Memory.vi	Moves a memory block on the ECU.
MC CCP Select Cal Page.vi	Sets the beginning of the calibration data page.
MC CCP Set Session Status.vi	Updates the ECU with the current state of the calibration session.
MC Characteristic Read.vi	Reads data from a named Characteristic on the ECU which is identified by the ECU Reference handle. The Poly VI returns a specific double, 1D, or 2D double array.
MC Characteristic Read Single Value.vi	Reads a value from a named Characteristic on the ECU which is identified by the ECU Reference handle.
MC Characteristic Write.vi	Writes the value(s) of a named Characteristic to an ECU identified by the ECU ref handle. The Poly VI writes the selected type double, 1D or 2D array.
MC Characteristic Write Single Value.vi	Writes a value to a named Characteristic on the ECU.
MC Clear Memory.vi	Clears the contents of a specified memory block.
MC Conversion Create.vi	Creates a signal conversion object in memory.
MC DAQ Clear.vi	Stops communication for the Measurement task and then clears the configuration.
MC DAQ Initialize.vi	Initializes a Measurement task for the specified Measurement channel list.
MC DAQ List Initialize.vi	Defines a DAQ list on a specific DAQ list number and initializes the Measurement task for the specified Measurement channel list.

Table 5-1. ECU M&C API VIs for LabVIEW (Continued)

Function	Purpose
MC DAQ Read.vi	Reads samples from a Measurement task. Samples are obtained from received CAN messages.
MC DAQ Start Stop.vi	Starts or stops transmission of the DAQ lists for the specified Measurement task.
MC DAQ Write.vi	Writes samples to a Measurement task.
MC Database Close.vi	Closes a specified A2L Database.
MC Database Open.vi	Opens a specified A2L Database.
MC Download.vi	Downloads data to an ECU.
MC ECU Close.vi	Closes the selected ECU and the associated A2L database.
MC ECU Connect.vi	Establishes the communication to the selected ECU through the CCP protocol. After a successful ECU Connect you can create a Measurement Task or read/write a Characteristic.
MC ECU Create.vi	Creates an ECU object in memory.
MC ECU Deselect.vi	Deselects an ECU and invalidates the ECU reference handle.
MC ECU Disconnect.vi	Permanently disconnects the CCP communication to the selected ECU and ends the calibration session.
MC ECU Open.vi	Opens a specified A2L database and selects the first ECU found in the database. If there are several ECUs stored in the A2L database use the Database Open and ECU Select VIs.
MC ECU Select.vi	Selects an ECU from the names stored in an A2L database.
MC Event Create.vi	Creates an Event object in memory.
MC Generic.vi	Sends a generic CCP or XCP command.
MC Get Names.vi	Gets an array of ECU names, Measurement names, Characteristic names, or Event names from a specified A2L database file.
MC Get Property.vi	Gets a property for the object referenced by the reference in terminal. The poly VI selection determines the property to get.
MC Measurement Create.vi	Creates a Measurement object in memory.
MC Measurement Read.vi	Reads a single Measurement value from the ECU.
MC Measurement Write.vi	Writes a single Measurement value to the ECU.

Table 5-1. ECU M&C API VIs for LabVIEW (Continued)

Function	Purpose
MC Program.vi	Programs a memory block on the ECU.
MC Program Reset.vi	Indicates the end of a programming sequence.
MC Program Start.vi	Indicates the start of a programming sequence.
MC Set Property.vi	Sets a property for the specified A2L database file, Measurement task or Characteristic. The poly VI selection determines the property to set.
MC Upload.vi	Uploads data from an ECU.
MC XCP Copy Cal Page.vi	Forces a copy transaction of one calibration page to another.
MC XCP Get Cal Page.vi	Queries a calibration page setting.
MC XCP Get ID.vi	Queries session configuration or slave device identification.
MC XCP Get Status.vi	Queries the current session status from an ECU slave device.
MC XCP Program Prepare.vi	Prepares the programming of non volatile memory.
MC XCP Program Verify.vi	Performs a non-volatile memory certification task on the ECU device.
MC XCP Set Cal Page.vi	Sets a calibration page.
MC XCP Set Request.vi	Performs a request to save session and device information to non-volatile memory.
MC XCP Set Segment Mode.vi	Sets the mode of a specified segment.

MC Build Checksum.vi

Purpose

Calculates a checksum over a defined memory range within the ECU.

Format

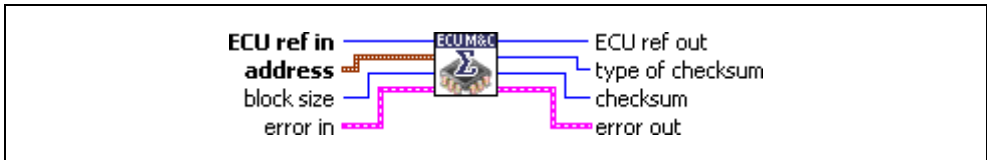

Input



ECU ref in is the task reference which links to the selected ECU. This reference is originally returned from [MC ECU Open.vi](#) or [MC ECU Select.vi](#), and then wired through subsequent VIs.



Address is a cluster which contains the following values.



Address specifies the address part of the source address.



Extension contains the extension part of the source address.



Block size determines the size of the block for which the checksum must be calculated.



Error in is a cluster which describes error conditions occurring before the VI executes. If an error has already occurred, the VI returns the value of the **error in** cluster to **error out**.



status is TRUE if an error occurred. This VI is not executed when **status** is TRUE.



code is the error code number identifying an error. A value of 0 means success. A negative value means error: VI did not execute the intended operation. A positive value means warning: VI executed intended operation, but an informational warning is returned. For a description of the **code**, wire the error cluster to a LabVIEW error-handling VI, such as the [Simple Error Handler](#).



source identifies the VI where the error occurred.

Output



ECU ref out is the same as **ECU ref in**. Wire the task reference to subsequent VIs for this task.



Type of checksum returns the type of the calculated checksum. If you are using the CCP protocol, **type of checksum** is 0xFF. For XCP, refer to the *Description* section.



Checksum returns the calculated checksum.



Error out describes error conditions. If the **Error in** cluster indicated an error, the **Error out** cluster contains the same information. Otherwise, **Error out** describes the error status of this VI.



status is `TRUE` if an error occurred.



code is the error code number identifying an error. A value of 0 means success. A negative value means error: VI did not execute the intended operation. A positive value means warning: VI executed intended operation, but an informational warning is returned. For a description of the **code**, wire the error cluster to a LabVIEW error-handling VI, such as the **Simple Error Handler**.



source identifies the VI where the error occurred.

Description

MC Build Checksum.vi calculates the checksum of a specified memory block inside the ECU starting at the selected Memory Transfer Address (MTA). The checksum algorithm is not specified by CCP and the checksum algorithm may be different on different devices.

If you are using the CCP protocol, **MC Build Checksum.vi** implements the CCP `BUILD_CHKSUM` command. The checksum algorithm is not specified by CCP and the checksum algorithm may be different on different devices.

If you are using the XCP protocol, **MC Build Checksum.vi** implements the BUILD_CHECKSUM command of the XCP specification. The result of the checksum calculation is returned in **Checksum** regardless of the checksum type. The following values for **type of checksum** are defined in the XCP specification:

Type	Name	Description
0x01	XCP_ADD_11	Add BYTE into a BYTE checksum, ignore overflows
0x02	XCP_ADD_12	Add BYTE into a WORD checksum, ignore overflows
0x03	XCP_ADD_14	Add BYTE into a DWORD checksum, ignore overflows
0x04	XCP_ADD_22	Add WORD into a WORD checksum, ignore overflows, block size must be modulo 2
0x05	XCP_ADD_24	Add WORD into a DWORD checksum, ignore overflows, block size must be modulo 2
0x06	XCP_ADD_44	Add DWORD into DWORD, ignore overflows, block size must be modulo 4
0x07	XCP_CRC_16	Refer to CRC error detection algorithms
0x08	XCP_CRC_16_CITT	Refer to CRC error detection algorithms
0x09	XCP_CRC_32	Refer to CRC error detection algorithms
0xFF	XCP_USER_DEFINED	User defined algorithm in externally calculated function

If **type of checksum** is returned as 0xFF (XCP_USER_DEFINED), the slave can indicate that the master for calculating the checksum must use a user-defined algorithm implemented in an externally calculated function (for instance, Win32 DLL, UNIX shared object file, etc.). The master gets the name of the external function file to be used for this slave from the ASAM MCD 2MC description file or from a property which can be set.

For a detailed description of the checksum algorithm, refer to the *XCP Part 2 Protocol Layer Specification*.

MC Calc Checksum.vi

Purpose

Calculates the checksum of a data block in memory.

Format

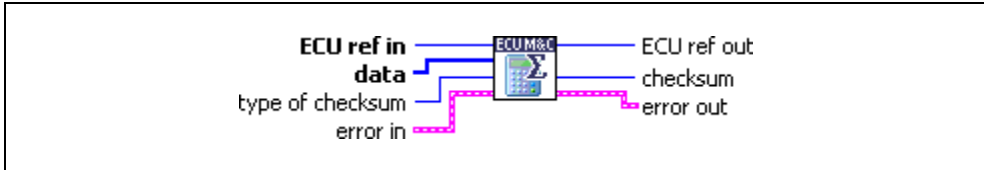

Input



ECU ref in is the task reference which links to the selected ECU. This reference is originally returned from **MC ECU Open.vi** or **MC ECU Select.vi**, and then wired through subsequent VIs.



Data is a byte array upon which the checksum calculation is performed.



Type of checksum specifies the kind of checksum which is calculated.



Error in is a cluster which describes error conditions occurring before the VI executes. If an error has already occurred, the VI returns the value of the **error in** cluster to **error out**.



status is **TRUE** if an error occurred. This VI is not executed when **status** is **TRUE**.



code is the error code number identifying an error. A value of 0 means success. A negative value means error: VI did not execute the intended operation. A positive value means warning: VI executed intended operation, but an informational warning is returned. For a description of the **code**, wire the error cluster to a LabVIEW error-handling VI, such as the **Simple Error Handler**.



source identifies the VI where the error occurred.

Output



ECU ref out is the same as **ECU ref in**. Wire the task reference to subsequent VIs for this task.



Checksum is the calculated checksum.



Error out describes error conditions. If the **Error in** cluster indicated an error, the **Error out** cluster contains the same information. Otherwise, **Error out** describes the error status of this VI.



status is TRUE if an error occurred.



code is the error code number identifying an error. A value of 0 means success. A negative value means error: VI did not execute the intended operation. A positive value means warning: VI executed intended operation, but an informational warning is returned. For a description of the **code**, wire the error cluster to a LabVIEW error-handling VI, such as the **Simple Error Handler**.



source identifies the VI where the error occurred.

Description

MC Calc Checksum.vi implements a checksum calculation over a given data block. The checksum algorithm is performed by the ECU M&C toolkit using a predefined algorithm (XCP only) or over a dedicated checksum function provided by a specific DLL. The Checksum DLL is defined in the A2L data base and can be changed by the application by the **MC Set Property.vi** using the **Checksum DLL Name** property.

If you are using the CCP protocol, **type of checksum** must always be set to 0xFF, as CCP supports an external checksum DLL only. If using XCP, the following values for **type of checksum** are defined in the XCP specification:

Type	Name	Description
0x01	XCP_ADD_11	Add BYTE into a BYTE checksum, ignore overflows
0x02	XCP_ADD_12	Add BYTE into a WORD checksum, ignore overflows
0x03	XCP_ADD_14	Add BYTE into a DWORD checksum, ignore overflows
0x04	XCP_ADD_22	Add WORD into a WORD checksum, ignore overflows, blocksize must be modulo 2
0x05	XCP_ADD_24	Add WORD into a DWORD checksum, ignore overflows, blocksize must be modulo 2

Type	Name	Description
0x06	XCP_ADD_44	Add DWORD into DWORD, ignore overflows, blocksize must be modulo 4
0x07	XCP_CRC_16	See CRC error detection algorithms
0x08	XCP_CRC_16_CITT	See CRC error detection algorithms
0x09	XCP_CRC_32	See CRC error detection algorithms
0xFF	XCP_USER_DEFINED	User defined algorithm, in externally calculated function

For a detailed description of the checksum algorithm, refer to the [MC Build Checksum.vi](#) or the *XCP Part 2 Protocol Layer Specification*.

For more detailed information about CRC algorithms, refer to the following site:

http://www.repairfaq.org/filipg/LINK/F_crc_v34.html

MC CCP Action Service.vi

Purpose

Calls an implementation-specific action service on the ECU (CCP only).

Format

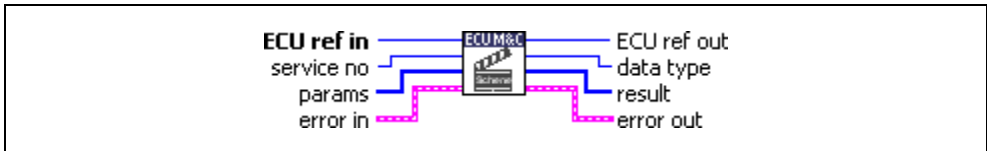

Input



ECU ref in is the task reference which links to the selected ECU. This reference is originally returned from **MC ECU Open.vi** or **MC ECU Select.vi**, and then wired through subsequent VIs.



Service No determines the service that is executed inside the ECU. For more information about the services that are implemented in the ECU, refer to the documentation for the ECU.



Params passes an array to the ECU that might be needed by the ECU to run the service. Since this VI has no knowledge about how the data is interpreted by the ECU, you are responsible for providing the data in the correct byte ordering.



Error in is a cluster which describes error conditions occurring before the VI executes. If an error has already occurred, the VI returns the value of the **error in** cluster to **error out**.



status is TRUE if an error occurred. This VI is not executed when **status** is TRUE.



code is the error code number identifying an error. A value of 0 means success. A negative value means error: VI did not execute the intended operation. A positive value means warning: VI executed intended operation, but an informational warning is returned. For a description of the **code**, wire the error cluster to a LabVIEW error-handling VI, such as the **Simple Error Handler**.



source identifies the VI where the error occurred.

Output



ECU ref out is the same as **ECU ref in**. Wire the task reference to subsequent VIs for this task.



Data type is a data type qualifier that determines the data format of the result.



Result returns information from the action service.



Error out describes error conditions. If the **Error in** cluster indicated an error, the **Error out** cluster contains the same information. Otherwise, **Error out** describes the error status of this VI.



status is **TRUE** if an error occurred.



code is the error code number identifying an error. A value of 0 means success. A negative value means error: VI did not execute the intended operation. A positive value means warning: VI executed intended operation, but an informational warning is returned. For a description of the **code**, wire the error cluster to a LabVIEW error-handling VI, such as the **Simple Error Handler**.



source identifies the VI where the error occurred.

Description

MC CCP Action Service.vi implements the CCP command **ACTION_SERVICE**. The ECU carries out the requested service and automatically uploads the requested action service return information.

MC CCP Diag Service.vi

Purpose

Calls a diagnostic service on the ECU (CCP only).

Format

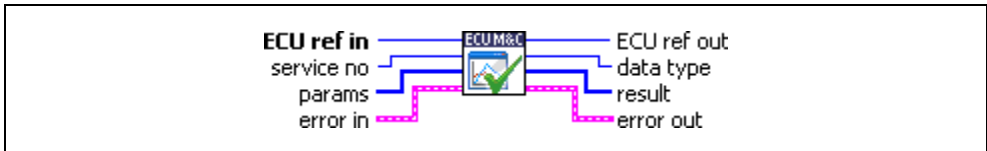

Input



ECU ref in is the task reference which links to the selected ECU. This reference is originally returned from **MC ECU Open.vi** or **MC ECU Select.vi**, and then wired through subsequent VIs.



Service no determines the diagnostic service that is executed inside the ECU. For more information about the services that are implemented in the ECU, refer to the documentation for the ECU.



Params passes an array to the ECU that might be needed by the ECU to run the service. Since this VI has no knowledge about how the data is interpreted by the ECU, you are responsible for providing the data in the correct byte ordering.



Error in is a cluster which describes error conditions occurring before the VI executes. If an error has already occurred, the VI returns the value of the **error in** cluster to **error out**.



status is TRUE if an error occurred. This VI is not executed when **status** is TRUE.



code is the error code number identifying an error. A value of 0 means success. A negative value means error: VI did not execute the intended operation. A positive value means warning: VI executed intended operation, but an informational warning is returned. For a description of the **code**, wire the error cluster to a LabVIEW error-handling VI, such as the **Simple Error Handler**.



source identifies the VI where the error occurred.

Output



ECU ref out is the same as **ECU ref in**. Wire the task reference to subsequent VIs for this task.



Data Type returns a Data Type Qualifier which provides information about the data type of the result of the diagnostic service.



Result contains the information returned from the diagnostic service, uploaded from the ECU by the CCP master.



Error out describes error conditions. If the **Error in** cluster indicated an error, the **Error out** cluster contains the same information. Otherwise, **Error out** describes the error status of this VI.



status is `TRUE` if an error occurred.



code is the error code number identifying an error. A value of 0 means success. A negative value means error: VI did not execute the intended operation. A positive value means warning: VI executed intended operation, but an informational warning is returned. For a description of the **code**, wire the error cluster to a LabVIEW error-handling VI, such as the **Simple Error Handler**.



source identifies the VI where the error occurred.

Description

MC CCP Diag Service.vi implements the CCP command `DIAG_SERVICE`, which starts a diagnostic service on the ECU and waits until it is finished. The selected **Service no** specifies the diagnostic service that is executed inside the ECU. For more information about the available services that are implemented in the ECU, refer to the documentation for the ECU.

MC CCP Get Active Cal Page.vi

Purpose

Retrieves the ECU Memory Transfer Address pointer to the calibration data page (CCP only).

Format

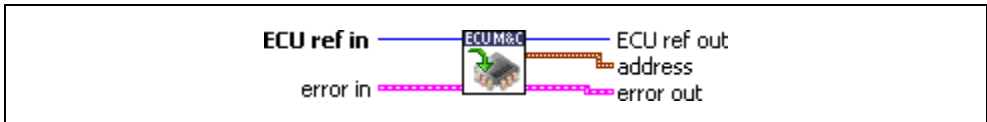

Input



ECU ref in is the task reference which links to the selected ECU. This reference is originally returned from **MC ECU Open.vi** or **MC ECU Select.vi**, and then wired through subsequent VIs.



Error in is a cluster which describes error conditions occurring before the VI executes. If an error has already occurred, the VI returns the value of the **error in** cluster to **error out**.



status is TRUE if an error occurred. This VI is not executed when **status** is TRUE.



code is the error code number identifying an error. A value of 0 means success. A negative value means error: VI did not execute the intended operation. A positive value means warning: VI executed intended operation, but an informational warning is returned. For a description of the **code**, wire the error cluster to a LabVIEW error-handling VI, such as the **Simple Error Handler**.



source identifies the VI where the error occurred.

Output



ECU ref out is the same as **ECU ref in**. Wire the task reference to subsequent VIs for this task.



Address is a cluster which contains the following values.



Address specifies the address part of the active calibration page address.



Extension contains the extension part of the active calibration page address.



Error out describes error conditions. If the **Error in** cluster indicated an error, the **Error out** cluster contains the same information. Otherwise, **Error out** describes the error status of this VI.



status is `TRUE` if an error occurred.



code is the error code number identifying an error. A value of 0 means success. A negative value means error: VI did not execute the intended operation. A positive value means warning: VI executed intended operation, but an informational warning is returned. For a description of the **code**, wire the error cluster to a LabVIEW error-handling VI, such as the **Simple Error Handler**.



source identifies the VI where the error occurred.

Description

MC CCP Get Active Cal Page.vi retrieves the ECU Memory Transfer Address pointer of the active calibration data page.

MC CCP Get Active Cal Page.vi implements the CCP command `GET_ACTIVE_CAL_PAGE` defined by the CCP specification.

MC CCP Get Result.vi

Purpose

Uploads requested data (CCP only).

Format

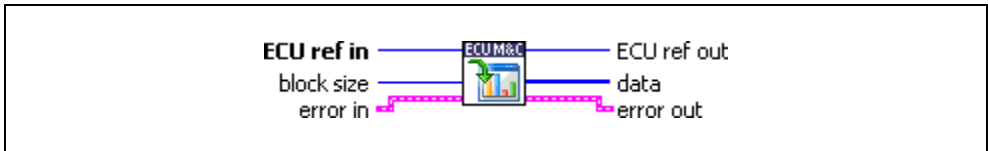

Input



ECU ref in is the task reference which links to the selected ECU. This reference is originally returned from **MC ECU Open.vi** or **MC ECU Select.vi**, and then wired through subsequent VIs.



Block size is the size of the data block, in bytes, to be uploaded.



Error in is a cluster which describes error conditions occurring before the VI executes. If an error has already occurred, the VI returns the value of the **error in** cluster to **error out**.



status is TRUE if an error occurred. This VI is not executed when **status** is TRUE.



code is the error code number identifying an error. A value of 0 means success. A negative value means error: VI did not execute the intended operation. A positive value means warning: VI executed intended operation, but an informational warning is returned. For a description of the **code**, wire the error cluster to a LabVIEW error-handling VI, such as the **Simple Error Handler**.



source identifies the VI where the error occurred.

Output



ECU ref out is the same as **ECU ref in**. Wire the task reference to subsequent VIs for this task.



Data is a byte array which receives the uploaded data information from the ECU.



Error out describes error conditions. If the **Error in** cluster indicated an error, the **Error out** cluster contains the same information. Otherwise, **Error out** describes the error status of this VI.



status is `TRUE` if an error occurred.



code is the error code number identifying an error. A value of 0 means success. A negative value means error: VI did not execute the intended operation. A positive value means warning: VI executed intended operation, but an informational warning is returned. For a description of the **code**, wire the error cluster to a LabVIEW error-handling VI, such as the **Simple Error Handler**.



source identifies the VI where the error occurred.

Description

MC CCP Get Result.vi uploads data bytes from the ECU. It is assumed that the Memory Transfer Address 0 (MTA0) has been set by a previous VI like **MC Generic.vi** with the command `SET_MTA`.

MC CCP Get Session Status.vi

Purpose

Retrieves the current calibration status of the ECU (CCP only).

Format

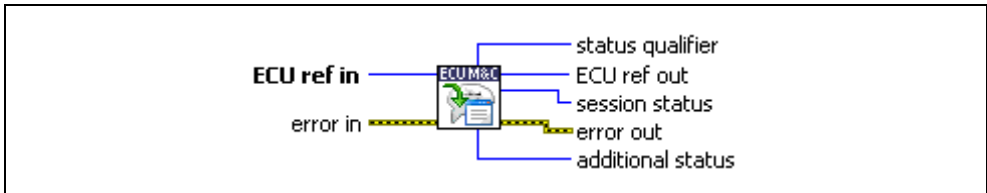

Input



ECU ref in is the task reference which links to the selected ECU. This reference is originally returned from **MC ECU Open.vi** or **MC ECU Select.vi**, and then wired through subsequent VIs.



Error in is a cluster which describes error conditions occurring before the VI executes. If an error has already occurred, the VI returns the value of the **error in** cluster to **error out**.



status is TRUE if an error occurred. This VI is not executed when **status** is TRUE.



code is the error code number identifying an error. A value of 0 means success. A negative value means error: VI did not execute the intended operation. A positive value means warning: VI executed intended operation, but an informational warning is returned. For a description of the **code**, wire the error cluster to a LabVIEW error-handling VI, such as the **Simple Error Handler**.



source identifies the VI where the error occurred.

Output



status qualifier describes an additional status qualifier. The additional status qualifier is manufacturer and/or project specific and is not part of the CCP protocol specification.



ECU ref out is the same as **ECU ref in**. Wire the task reference to subsequent VIs for this task.



session status is the actual session status which is returned from the ECU.



Error out describes error conditions. If the **Error in** cluster indicated an error, the **Error out** cluster contains the same information. Otherwise, **Error out** describes the error status of this VI.



status is TRUE if an error occurred.



code is the error code number identifying an error. A value of 0 means success. A negative value means error: VI did not execute the intended operation. A positive value means warning: VI executed intended operation, but an informational warning is returned. For a description of the **code**, wire the error cluster to a LabVIEW error-handling VI, such as the **Simple Error Handler**.



source identifies the VI where the error occurred.



additional status describes an additional status qualifier. If the status qualifier does not contain additional status information, the **additional status** parameter must be set to FALSE. If the **additional status** parameter is not FALSE, it may be used to determine the type of the additional status information.

Description

MC CCP Get Session Status.vi retrieves the session status of the ECU. The return value **session status** is a bit mask that represents several session states inside the ECU. **status qualifier** specifies the additional status information. **additional status** contains the additional status information. The content of these parameters is project specific and not defined by CCP. For more information about these parameters, refer to the documentation for the ECU.

MC CCP Get Session Status.vi implements the CCP command GET_S_STATUS defined by the CCP specification.

MC CCP Get Version.vi

Purpose

Retrieves version of the CCP implemented in the ECU (CCP only).

Format

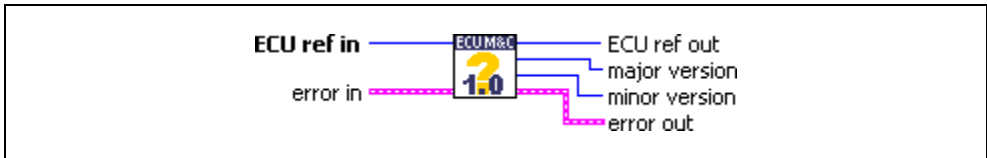

Input



ECU ref in is the task reference which links to the selected ECU. This reference is originally returned from [MC ECU Open.vi](#) or [MC ECU Select.vi](#), and then wired through subsequent VIs.



Error in is a cluster which describes error conditions occurring before the VI executes. If an error has already occurred, the VI returns the value of the **error in** cluster to **error out**.



status is TRUE if an error occurred. This VI is not executed when **status** is TRUE.



code is the error code number identifying an error. A value of 0 means success. A negative value means error: VI did not execute the intended operation. A positive value means warning: VI executed intended operation, but an informational warning is returned. For a description of the **code**, wire the error cluster to a LabVIEW error-handling VI, such as the **Simple Error Handler**.



source identifies the VI where the error occurred.

Output



ECU ref out is the same as **ECU ref in**. Wire the task reference to subsequent VIs for this task.



Major version returns the major version number of the CCP implementation.



Minor version returns the minor version number of the CCP implementation.



Error out describes error conditions. If the **Error in** cluster indicated an error, the **Error out** cluster contains the same information. Otherwise, **Error out** describes the error status of this VI.



status is `TRUE` if an error occurred.



code is the error code number identifying an error. A value of 0 means success. A negative value means error: VI did not execute the intended operation. A positive value means warning: VI executed intended operation, but an informational warning is returned. For a description of the **code**, wire the error cluster to a LabVIEW error-handling VI, such as the **Simple Error Handler**.



source identifies the VI where the error occurred.

Description

MC CCP Get Version.vi can be used to query the CCP version implemented in the ECU. This command performs a mutual identification of the protocol version in the slave device to agree on a common protocol version.

MC CCP Get Version.vi implements the CCP command `GET_CCP_VERSION` defined by the CCP specification.

MC CCP Move Memory.vi

Purpose

Moves a memory block on the ECU (CCP only).

Format

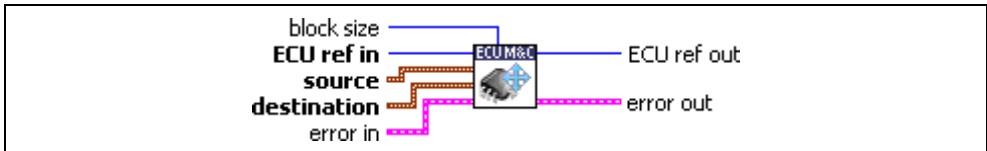

Input



Block size determines the size of memory block in bytes which should be moved from the source address to the destination address.



ECU ref in is the task reference which links to the selected ECU. This reference is originally returned from [MC ECU Open.vi](#) or [MC ECU Select.vi](#), and then wired through subsequent VIs.



Source is a cluster which contains the following values.



Address specifies the address part of the source address from which the memory block is copied.



Extension specifies the extension part of the source address.



Destination is a cluster which contains the following values.



Address specifies the address part of the destination address to which the memory block is copied.



Extension specifies the extension part of the destination address.



Error in is a cluster which describes error conditions occurring before the VI executes. If an error has already occurred, the VI returns the value of the **error in** cluster to **error out**.



status is TRUE if an error occurred. This VI is not executed when **status** is TRUE.



code is the error code number identifying an error. A value of 0 means success. A negative value means error: VI did not execute the intended operation. A positive value means warning: VI executed intended operation, but an informational warning is returned. For a description of the **code**, wire the error cluster to a LabVIEW error-handling VI, such as the **Simple Error Handler**.



source identifies the VI where the error occurred.

Output



ECU ref out is the same as **ECU ref in**. Wire the task reference to subsequent VIs for this task.



Error out describes error conditions. If the **Error in** cluster indicated an error, the **Error out** cluster contains the same information. Otherwise, **Error out** describes the error status of this VI.



status is TRUE if an error occurred.



code is the error code number identifying an error. A value of 0 means success. A negative value means error: VI did not execute the intended operation. A positive value means warning: VI executed intended operation, but an informational warning is returned. For a description of the **code**, wire the error cluster to a LabVIEW error-handling VI, such as the **Simple Error Handler**.



source identifies the VI where the error occurred.

Description

MC CCP Move Memory.vi is used to move the memory contents of an ECU from one memory location to another. Before calling the CCP MOVE command this function sets the Memory Transfer Address pointers MTA0 as defined in the source cluster and MTA1 as defined in the destination cluster to appropriate values.

MC CCP Move Memory.vi implements the CCP command MOVE defined by the CCP specification.

MC CCP Select Cal Page.vi

Purpose

Sets the beginning of the calibration data page (CCP only).

Format

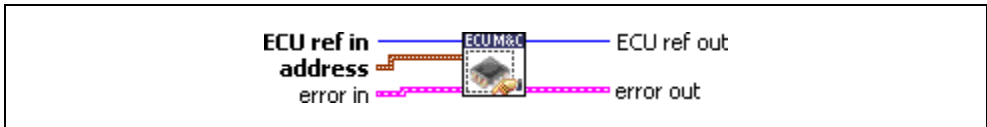

Input



ECU ref in is the task reference which links to the selected ECU. This reference is originally returned from [MC ECU Open.vi](#) or [MC ECU Select.vi](#), and then wired through subsequent VIs.



Address is a cluster which contains the following values.



Address specifies the address part of the address.



Extension contains the extension part of the address.



Error in is a cluster which describes error conditions occurring before the VI executes. If an error has already occurred, the VI returns the value of the **error in** cluster to **error out**.



status is TRUE if an error occurred. This VI is not executed when **status** is TRUE.



code is the error code number identifying an error. A value of 0 means success. A negative value means error: VI did not execute the intended operation. A positive value means warning: VI executed intended operation, but an informational warning is returned. For a description of the **code**, wire the error cluster to a LabVIEW error-handling VI, such as the **Simple Error Handler**.



source identifies the VI where the error occurred.

Output



ECU ref out is the same as **ECU ref in**. Wire the task reference to subsequent VIs for this task.



Error out describes error conditions. If the **Error in** cluster indicated an error, the **Error out** cluster contains the same information. Otherwise, **Error out** describes the error status of this VI.



status is `TRUE` if an error occurred.



code is the error code number identifying an error. A value of 0 means success. A negative value means error: VI did not execute the intended operation. A positive value means warning: VI executed intended operation, but an informational warning is returned. For a description of the **code**, wire the error cluster to a LabVIEW error-handling VI, such as the **Simple Error Handler**.



source identifies the VI where the error occurred.

Description

[MC CCP Select Cal Page.vi](#) implements the CCP command `SELECT_CAL_PAGE`. The operation of the command depends on the ECU implementation.

MC CCP Set Session Status.vi

Purpose

Updates the ECU with the current state of the calibration session (CCP only).

Format

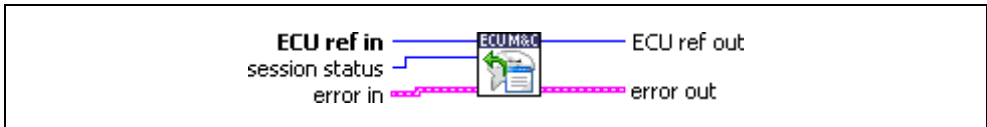

Input



ECU ref in is the task reference which links to the selected ECU. This reference is originally returned from [MC ECU Open.vi](#) or [MC ECU Select.vi](#), and then wired through subsequent VIs.



Session status is the new status to be set in the ECU.



Error in is a cluster which describes error conditions occurring before the VI executes. If an error has already occurred, the VI returns the value of the **error in** cluster to **error out**.



status is TRUE if an error occurred. This VI is not executed when **status** is TRUE.



code is the error code number identifying an error. A value of 0 means success. A negative value means error: VI did not execute the intended operation. A positive value means warning: VI executed intended operation, but an informational warning is returned. For a description of the **code**, wire the error cluster to a LabVIEW error-handling VI, such as the [Simple Error Handler](#).



source identifies the VI where the error occurred.

Output



ECU ref out is the same as **ECU ref in**. Wire the task reference to subsequent VIs for this task.



Error out describes error conditions. If the **Error in** cluster indicated an error, the **Error out** cluster contains the same information. Otherwise, **Error out** describes the error status of this VI.



status is TRUE if an error occurred.

code is the error code number identifying an error. A value of 0 means success. A negative value means error: VI did not execute the intended operation. A positive value means warning: VI executed intended operation, but an informational warning is returned. For a description of the **code**, wire the error cluster to a LabVIEW error-handling VI, such as the **Simple Error Handler**.



source identifies the VI where the error occurred.

Description

This VI implements the CCP SET_S_STATUS command and is used to keep the ECU informed about the current state of the calibration session. The session status bits of an ECU can be read and written. Possible conditions are: reset on power-up, session log-off, and in applicable error conditions. The calibration session status is organized as a bit mask with the following assignment.

Table 5-2. Bit Mask Assignment for Calibration Session Status

Bit	Name	Description
0	CAL	Calibration data initialized.
1	DAQ	DAQ list(s) initialized.
2	RESUME	Request to save DAQ set-up during shutdown in CCP slave. CCP slave automatically restarts DAQ after start-up.
3	Reserved	—
4	Reserved	—
5	Reserved	—
6	STORE	Request to save calibration data during shut-down in CCP slave.
7	RUN	Session in progress.

MC Characteristic Read.vi

Purpose

Reads data from a named Characteristic on the ECU which is identified by the ECU Reference handle. The Poly VI returns a specific double, 1D, or 2D double array.

Format

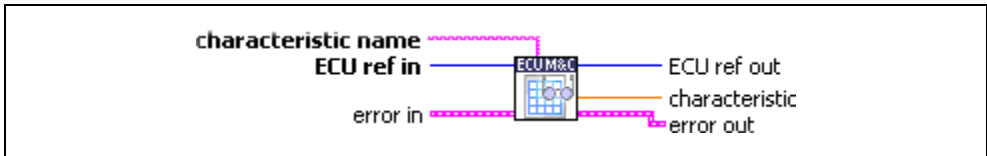

Input



Characteristic name is the name of the Characteristic defined in the A2L database.



ECU ref in is the task reference which links to the selected ECU. This reference is originally returned from [MC ECU Open.vi](#) or [MC ECU Select.vi](#), and then wired through subsequent VIs.



Error in is a cluster which describes error conditions occurring before the VI executes. If an error has already occurred, the VI returns the value of the **error in** cluster to **error out**.



status is TRUE if an error occurred. This VI is not executed when **status** is TRUE.



code is the error code number identifying an error. A value of 0 means success. A negative value means error: VI did not execute the intended operation. A positive value means warning: VI executed intended operation, but an informational warning is returned. For a description of the **code**, wire the error cluster to a LabVIEW error-handling VI, such as the [Simple Error Handler](#).



source identifies the VI where the error occurred.

Output



ECU ref out is the same as **ECU ref in**. Wire the task reference to subsequent VIs for this task.



Characteristic is a poly output value which represents the data read from the ECU. The type of the poly output is determined by the poly VI selection. For information on the different poly VI types provided by **MC Characteristic Read.vi**, refer to the *Poly VI Types* section.

To select the data type, right-click the VI, go to **Select Type**, and select the type by name.



Error out describes error conditions. If the **Error in** cluster indicated an error, the **Error out** cluster contains the same information. Otherwise, **Error out** describes the error status of this VI.



status is `TRUE` if an error occurred.



code is the error code number identifying an error. A value of 0 means success. A negative value means error: VI did not execute the intended operation. A positive value means warning: VI executed intended operation, but an informational warning is returned. For a description of the **code**, wire the error cluster to a LabVIEW error-handling VI, such as the **Simple Error Handler**.



source identifies the VI where the error occurred.

Description

Poly VI Types

Table 5-3. Poly VI Types for the Value Parameter

VI Type	Description
Parameter (DBL)	Returns a single double value for the selected Characteristic name.
Curve (1D)	Returns a 1-dimensional array of double values for the selected Characteristic name.
Field (2D)	Returns a 2-dimensional array of double values for the selected Characteristic name.

MC Characteristic Read Single Value.vi

Purpose

Reads a value from a named Characteristic on the ECU which is identified by the ECU Reference handle.

Format

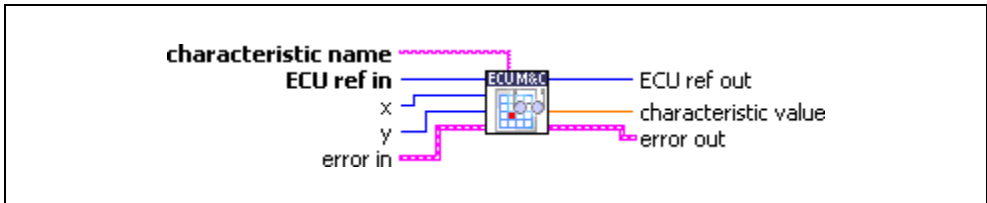

Input



Characteristic name is the name of the Characteristic defined in the A2L database.



ECU ref in is the task reference which links to the selected ECU. This reference is originally returned from [MC ECU Open.vi](#) or [MC ECU Select.vi](#), and then wired through subsequent VIs.



x is the horizontal index if the Characteristic consists of 1 or 2 dimensions.



y is the vertical index if the Characteristic consists of 2 dimensions.



Error in is a cluster which describes error conditions occurring before the VI executes. If an error has already occurred, the VI returns the value of the **error in** cluster to **error out**.



status is TRUE if an error occurred. This VI is not executed when **status** is TRUE.



code is the error code number identifying an error. A value of 0 means success. A negative value means error: VI did not execute the intended operation. A positive value means warning: VI executed intended operation, but an informational warning is returned. For a description of the **code**, wire the error cluster to a LabVIEW error-handling VI, such as the **Simple Error Handler**.



source identifies the VI where the error occurred.

Output



ECU ref out is the same as **ECU ref in**. Wire the task reference to subsequent VIs for this task.



Characteristic value returns a single sample for the specified Characteristic.



Error out describes error conditions. If the **Error in** cluster indicated an error, the **Error out** cluster contains the same information. Otherwise, **Error out** describes the error status of this VI.



status is `TRUE` if an error occurred.



code is the error code number identifying an error. A value of 0 means success. A negative value means error: VI did not execute the intended operation. A positive value means warning: VI executed intended operation, but an informational warning is returned. For a description of the **code**, wire the error cluster to a LabVIEW error-handling VI, such as the **Simple Error Handler**.



source identifies the VI where the error occurred.

Description

MC Characteristic Read Single Value.vi reads a value from a specified Characteristic on the ECU which is identified by the ECU Reference handle. The value to be read is identified by the **x** and **y** indices. If the Characteristic array has 0 or 1 dimensions, **y** and/or **x** can be left unwired.

MC Characteristic Write.vi

Purpose

Writes the value(s) of a named Characteristic to an ECU identified by the ECU ref handle. The Poly VI writes the selected type double, 1D or 2D array.

Format

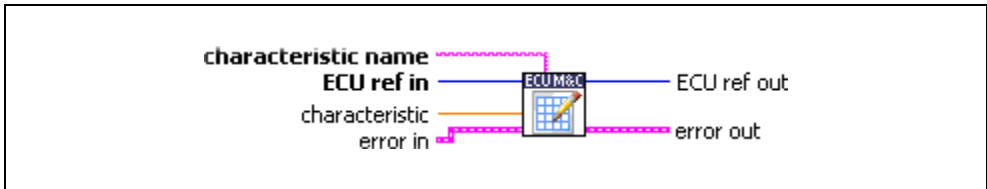

Input



Characteristic name is the name of a Characteristic stored in the A2L database file to which one or more values may be written.



ECU ref in is the task reference which links to the selected ECU. This reference is originally returned from [MC ECU Open.vi](#) or [MC ECU Select.vi](#), and then wired through subsequent VIs.



Characteristic writes the data for the Characteristic channel initialized by **Characteristic name**. **Characteristic** values are listed in the *Poly VI Types* section.



Error in is a cluster which describes error conditions occurring before the VI executes. If an error has already occurred, the VI returns the value of the **error in** cluster to **error out**.



status is TRUE if an error occurred. This VI is not executed when **status** is TRUE.



code is the error code number identifying an error. A value of 0 means success. A negative value means error: VI did not execute the intended operation. A positive value means warning: VI executed intended operation, but an informational warning is returned. For a description of the **code**, wire the error cluster to a LabVIEW error-handling VI, such as the **Simple Error Handler**.



source identifies the VI where the error occurred.

Output



ECU ref out is the same as **ECU ref in**. Wire the task reference to subsequent VIs for this task.



Error out describes error conditions. If the **Error in** cluster indicated an error, the **Error out** cluster contains the same information. Otherwise, **Error out** describes the error status of this VI.



status is `TRUE` if an error occurred.



code is the error code number identifying an error. A value of 0 means success. A negative value means error: VI did not execute the intended operation. A positive value means warning: VI executed intended operation, but an informational warning is returned. For a description of the **code**, wire the error cluster to a LabVIEW error-handling VI, such as the **Simple Error Handler**.



source identifies the VI where the error occurred.

Description

Poly VI Types

Table 5-4. Poly VI Types for the Characteristic Parameter

VI Type	Description
Parameter (DBL)	Writes a single double value to the selected Characteristic name.
Curve (1D)	Writes a 1-dimensional array of double values to the selected Characteristic name.
Field (2D)	Writes a 2-dimensional array of double values to the selected Characteristic name.

MC Characteristic Write Single Value.vi

Purpose

Writes a value to a named Characteristic on the ECU.

Format

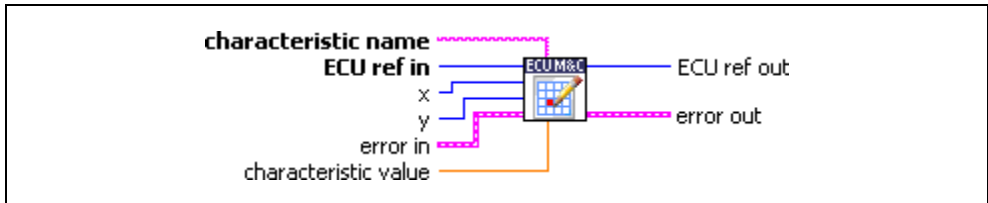

Input



Characteristic name is the name of a Characteristic stored in the A2L database file to which one value may be written.



ECU ref in is the task reference which links to the selected ECU. This reference is originally returned from [MC ECU Open.vi](#) or [MC ECU Select.vi](#), and then wired through subsequent VIs.



x is an input that refers to the array offset if the Characteristic is defined in the A2L database file as 1- or 2-dimensional. If the Characteristic is defined as having 0 dimensions, the input can be left unwired.



y is an input that refers to the array offset if the Characteristic is defined in the A2L database file as 2-dimensional. If the Characteristic is defined as having 0 or 1 dimensions, the input can be left unwired.



Error in is a cluster which describes error conditions occurring before the VI executes. If an error has already occurred, the VI returns the value of the **error in** cluster to **error out**.





status is TRUE if an error occurred. This VI is not executed when **status** is TRUE.





code is the error code number identifying an error. A value of 0 means success. A negative value means error: VI did not execute the intended operation. A positive value means warning: VI executed intended operation, but an informational warning is returned. For a description of the **code**, wire the error cluster to a LabVIEW error-handling VI, such as the **Simple Error Handler**.

Output

  **source** identifies the VI where the error occurred.

Characteristic value is the value to be set for the Characteristic.

 **ECU ref out** is the same as **ECU ref in**. Wire the task reference to subsequent VIs for this task.

 **Error out** describes error conditions. If the **Error in** cluster indicated an error, the **Error out** cluster contains the same information. Otherwise, **Error out** describes the error status of this VI.

 **status** is `TRUE` if an error occurred.

 **code** is the error code number identifying an error. A value of 0 means success. A negative value means error: VI did not execute the intended operation. A positive value means warning: VI executed intended operation, but an informational warning is returned. For a description of the **code**, wire the error cluster to a LabVIEW error-handling VI, such as the **Simple Error Handler**.

 **source** identifies the VI where the error occurred.

Description

MC Characteristic Write Single Value.vi writes a value to a defined Characteristic on the ECU which is identified by the ECU Reference handle. The location to which the value is written is identified by the **x** and **y** indices. If the Characteristic array has 0 or 1 dimensions, **y** and/or **x** can be left unwired.

MC Clear Memory.vi

Purpose

Clears the contents of a specified memory block.

Format

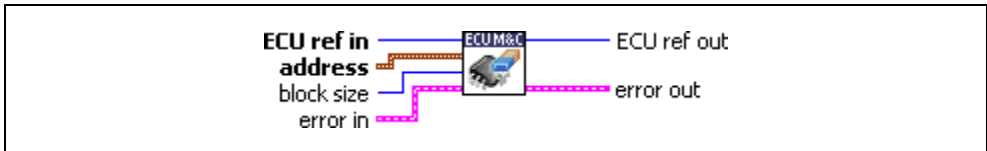

Input



ECU ref in is the task reference which links to the selected ECU. This reference is originally returned from **MC ECU Open.vi** or **MC ECU Select.vi**, and then wired through subsequent VIs.



Address is a cluster which contains the following values.



Address specifies the address part of the source address.



Extension contains the extension part of the source address.



Block size determines the size of the block that must be cleared.



Error in is a cluster which describes error conditions occurring before the VI executes. If an error has already occurred, the VI returns the value of the **error in** cluster to **error out**.



status is TRUE if an error occurred. This VI is not executed when **status** is TRUE.



code is the error code number identifying an error. A value of 0 means success. A negative value means error: VI did not execute the intended operation. A positive value means warning: VI executed intended operation, but an informational warning is returned. For a description of the **code**, wire the error cluster to a LabVIEW error-handling VI, such as the **Simple Error Handler**.



source identifies the VI where the error occurred.

Output



ECU ref out is the same as **ECU ref in**. Wire the task reference to subsequent VIs for this task.



Error out describes error conditions. If the **Error in** cluster indicated an error, the **Error out** cluster contains the same information. Otherwise, **Error out** describes the error status of this VI.



status is `TRUE` if an error occurred.



code is the error code number identifying an error. A value of 0 means success. A negative value means error: VI did not execute the intended operation. A positive value means warning: VI executed intended operation, but an informational warning is returned. For a description of the **code**, wire the error cluster to a LabVIEW error-handling VI, such as the **Simple Error Handler**.



source identifies the VI where the error occurred.

Description

MC Clear Memory.vi can be used to erase the FLASH EPROM prior to reprogramming. If you are using CCP, the CCP Memory Transfer address (MTA0) pointer is set to the memory location to be erased specified by the parameters **Address** and **Extension**. **MC Clear Memory.vi** implements the CCP `CLEAR_MEMORY` command defined by the CCP specification.

If you are using the XCP protocol, **MC Clear Memory.vi** implements the `PROGRAM_CLEAR` command.

For further details on how to clear parts of non-volatile memory in the ECU refer to the *ASAM XCP Protocol Layer Specification*.

MC Conversion Create.vi

Purpose

Creates a signal conversion object in memory.

Format

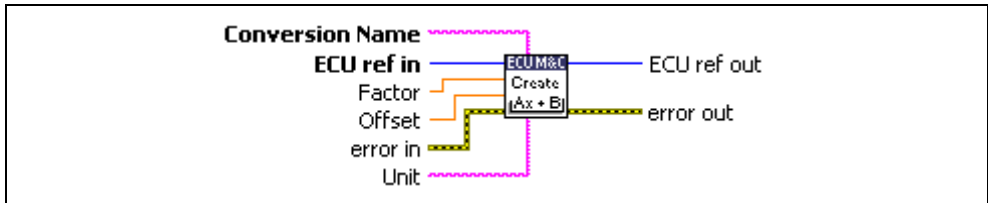

Input



Conversion Name identifies the conversion object that handles the scaling of a measurement.



ECU ref in is the task reference that links to the selected ECU. This reference is originally returned from [MC ECU Open.vi](#) or [MC ECU Create.vi](#).



Factor configures the scaling factor used to convert raw measurement data in the message to/from scaled floating-point units. The factor is the A in the linear scaling formula $AX+B$, where X is the raw data, and B is the scaling offset.



Offset configures the scaling offset used to convert raw data in the measurement message to/from scaled floating-point units. The scaling offset is the B in the linear scaling formula $AX+B$, where X is the raw data, and A is the scaling factor.



Error in is a cluster which describes error conditions occurring before the VI executes. If an error has already occurred, the VI returns the value of the **error in** cluster to **error out**.



status is TRUE if an error occurred. This VI is not executed when **status** is TRUE.



code is the error code number identifying an error. A value of 0 means success. A negative value means error: VI did not execute the intended operation. A positive value means warning: VI executed intended operation, but an informational warning is

returned. For a description of the **code**, wire the error cluster to a LabVIEW error-handling VI, such as the **Simple Error Handler**.



source identifies the VI where the error occurred.



Unit configures the measurement channel unit string. You can use this value to display units (such as volts or RPM) along with the samples of the channel.

Output



ECU ref out is the task reference that links to the selected ECU.



Error out describes error conditions. If the **Error in** cluster indicated an error, the **Error out** cluster contains the same information. Otherwise, **Error out** describes the error status of this VI.



status is `TRUE` if an error occurred.



code is the error code number identifying an error. A value of 0 means success. A negative value means error: VI did not execute the intended operation. A positive value means warning: VI executed intended operation, but an informational warning is returned. For a description of the **code**, wire the error cluster to a LabVIEW error-handling VI, such as the **Simple Error Handler**.



source identifies the VI where the error occurred.

Description

Use **MC Conversion Create.vi** to create a conversion object in memory instead of referring to measurement properties defined in the A2L database.

MC DAQ Clear.vi

Purpose

Stops communication for the Measurement task and then clears the configuration.

Format

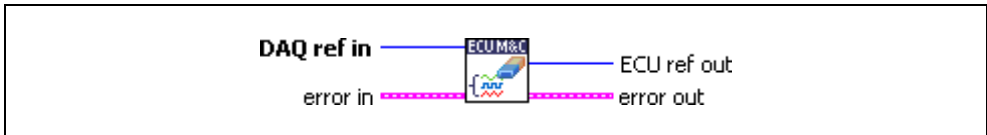

Input



DAQ ref in is the task reference which links to the Measurement task. This reference is originally returned from [MC DAQ Initialize.vi](#), and then wired through subsequent VIs.



Error in is a cluster which describes error conditions occurring before the VI executes. If an error has already occurred, the VI returns the value of the **error in** cluster to **error out**.



status is TRUE if an error occurred. Unlike other VIs, this VI will execute when **status** is TRUE.



code is the error code number identifying an error. A value of 0 means success. A negative value means error: VI did not execute the intended operation. A positive value means warning: VI executed intended operation, but an informational warning is returned. For a description of the **code**, wire the error cluster to a LabVIEW error-handling VI, such as the **Simple Error Handler**.



source identifies the VI where the error occurred.

Output



ECU ref out is the ECU reference upon which [MC DAQ Initialize.vi](#) was called. Wire this to subsequent ECU operations.



Error out describes error conditions. If the **Error in** cluster indicated an error, the **Error out** cluster contains the same information. Otherwise, **Error out** describes the error status of this VI.



status is TRUE if an error occurred.



code is the error code number identifying an error. A value of 0 means success. A negative value means error: VI did not execute the intended operation. A positive value means warning: VI executed intended operation, but an informational warning is returned. For a description of the **code**, wire the error cluster to a LabVIEW error-handling VI, such as the **Simple Error Handler**.



source identifies the VI where the error occurred.

Description

MC DAQ Clear.vi must always be the final ECU M&C VI called for a Measurement task. If you do not use the **MC DAQ Clear.vi**, the remaining task configurations can cause problems in execution of subsequent ECU M&C applications.

Because this VI clears the Measurement task, the Measurement task reference is not wired as an output but is transferred into an ECU reference task handle. To change properties of a running Measurement task, use **MC DAQ Start Stop.vi** to stop the task, **MC Set Property.vi** to change the desired DAQ property, and then **MC DAQ Start Stop.vi** to restart the Measurement task again.

MC DAQ Initialize.vi

Purpose

Initializes a Measurement task for the specified Measurement channel list.

Format

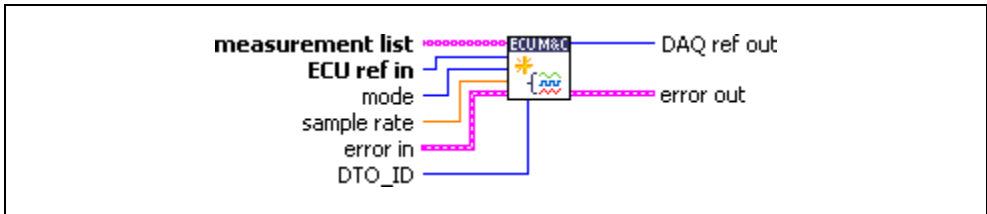

Input



Measurement list is the array of channel names to initialize as a Measurement task. Each channel name is provided in an array entry.



ECU ref in is the task reference which links to the selected ECU. This reference is originally returned from [MC ECU Open.vi](#) or [MC ECU Select.vi](#), and then wired through subsequent VIs.



Mode specifies the I/O mode for the task. For an overview of the I/O modes, including figures, refer to the [Basic Programming Model](#) section of Chapter 4, [Using the ECU M&C API](#).

Mode=0

DAQ List: The data is transmitted from the ECU in equidistant time intervals as defined in the A2L database. The data can be read back with the [MC DAQ Read.vi](#) as Single point data using a sample rate = 0 or as waveform using a sample rate > 0. Input channel data are received from the DAQ messages. Use [MC DAQ Read.vi](#) to obtain input samples as single-point, array, or waveform.

Mode=1

Polling: In this mode the data from the Measurement task are acquired from the ECU whenever the [MC DAQ Read.vi](#) is called.

Mode=2

STIM List: In this mode the data from the Measurement task are sent to the ECU whenever [MC DAQ Write.vi](#) is called.

Mode = 3

Timestamped read: The data is transmitted from the ECU in equidistant time intervals as defined in the A2L database. The data can be read back with **MC DAQ Read.vi** as timestamped data array. Input channel data are received from the DAQ messages. Use **MC DAQ Read.vi** to obtain input samples as an array of sample/timestamp pairs (poly VI types ending in Timestamped Dbl). Use this input mode to read samples with timestamps that indicate when each channel is received from the network.



Sample rate specifies the timing to use for samples of the task. The sample rate is specified in Hertz (samples per second). A sample rate of zero means to sample immediately. If the **Mode** is defined as DAQ list, a sample rate of zero means that **MC DAQ Read.vi** returns a single point from the most recent message received, and greater than zero means that **MC DAQ Read.vi** returns samples timed at the specified rate. If the **Mode** is defined as Polling, the sample rate is ignored.



Error in is a cluster which describes error conditions occurring before the VI executes. If an error has already occurred, the VI returns the value of the **error in** cluster to **error out**.



status is TRUE if an error occurred. This VI will not execute when **status** is TRUE.



code is the error code number identifying an error. A value of 0 means success. A negative value means error: VI did not execute the intended operation. A positive value means warning: VI executed intended operation, but an informational warning is returned. For a description of the **code**, wire the error cluster to a LabVIEW error-handling VI, such as the **Simple Error Handler**.



source identifies the VI where the error occurred.



DTO_ID is the CAN identifier for the **Data Transmission Object (DTO)** used by the ECU to transmit the DAQ list data to the host. If the **DTO_ID** terminal is unwired the ECU will use the same identifier for sending the DAQ list data as for the normal CCP communication.

Output



DAQ ref out is a task reference for the Measurement task created. Wire this task reference to subsequent VIs for this Measurement task.



Error out describes error conditions. If the **Error in** cluster indicated an error, the **Error out** cluster contains the same information. Otherwise, **Error out** describes the error status of this VI.



status is TRUE if an error occurred.



code is the error code number identifying an error. A value of 0 means success. A negative value means error: VI did not execute the intended operation. A positive value means warning: VI executed intended operation, but an informational warning is returned. For a description of the **code**, wire the error cluster to a LabVIEW error-handling VI, such as the **Simple Error Handler**.



source identifies the VI where the error occurred.

Description

MC DAQ Initialize.vi does not start the transmission of the DAQ lists from the ECU to or from the application through CCP or XCP. This enables you to use **MC Set Property.vi** to change the properties of a Measurement task. After you change properties use **MC DAQ Start Stop.vi** to start the communication for the Measurement task.

MC DAQ List Initialize.vi

Purpose

Defines a DAQ list on a specific DAQ list number and initializes the Measurement task for the specified Measurement channel list.

Format

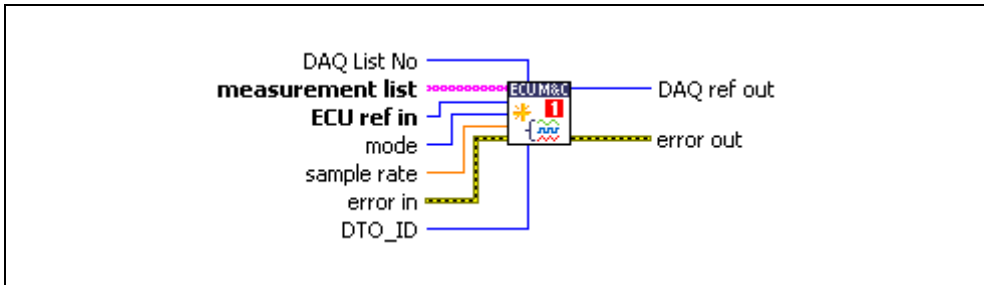

Input



DAQ List No specifies which DAQ list entry number should be used for the defined Measurement channel list for the selected ECU. To query the available DAQ List numbers on the ECU use [MC Get Property.vi](#) and select **DAQ List Number** in the Poly VI.



Measurement list is the array of channel names to initialize as a Measurement task. Each channel name is provided in an array entry.



ECU ref in is the task reference which links to the selected ECU. This reference is originally returned from [MC ECU Open.vi](#) or [MC ECU Select.vi](#), and then wired through subsequent VIs.



Mode specifies the I/O mode for the task. For an overview of the I/O modes, including figures, refer to the *Basic Programming Model* section of Chapter 4, *Using the ECU M&C API*.

Mode=0

DAQ List: The data is transmitted from the ECU in equidistant time intervals as defined in the A2L database. The data can be read back with the [MC DAQ Read.vi](#) as Single point data using a sample rate = 0 or as waveform using a sample rate > 0. Input channel data are received from the DAQ messages. Use [MC DAQ Read.vi](#) to obtain input samples as single-point, array, or waveform.

Mode=1

Polling: In this mode the data from the Measurement task are acquired from the ECU whenever the **MC DAQ Read.vi** is called.

Mode=2

STIM List: In this mode the data from the Measurement task are sent to the ECU whenever **MC DAQ Write.vi** is called.

Mode = 3

Timestamped read: The data is transmitted from the ECU in equidistant time intervals as defined in the A2L database. The data can be read back with **MC DAQ Read.vi** as timestamped data array. Input channel data are received from the DAQ messages. Use **MC DAQ Read.vi** to obtain input samples as an array of sample/timestamp pairs (Poly VI types ending in Timestamped Dbl). Use this input mode to read samples with timestamps that indicate when each channel is received from the network.



Sample rate specifies the timing to use for samples of the task. The sample rate is specified in Hertz (samples per second). A sample rate of zero means to sample immediately. If the **Mode** is defined as **DAQ List**, a sample rate of zero means that **MC DAQ Read.vi** returns a single point from the most recent message received, and greater than zero means that **MC DAQ Read.vi** returns samples timed at the specified rate. If the **Mode** is defined as **Polling**, the sample rate is ignored.



Error in is a cluster which describes error conditions occurring before the VI executes. If an error has already occurred, the VI returns the value of the **error in** cluster to **error out**.



status is **TRUE** if an error occurred. This VI will not execute when **status** is **TRUE**.



code is the error code number identifying an error. A value of 0 means success. A negative value means error: VI did not execute the intended operation. A positive value means warning: VI executed intended operation, but an informational warning is returned. For a description of the **code**, wire the error cluster to a LabVIEW error-handling VI, such as the **Simple Error Handler**.



source identifies the VI where the error occurred.



DTO_ID is the CAN identifier for the **Data Transmission Object (DTO)** used by the ECU to transmit the DAQ list data to the host. If the **DTO_ID** terminal is unwired the ECU will use the same identifier for sending the DAQ list data as for the normal CCP communication.

Output



DAQ_ref_out is a task reference for the Measurement task created. Wire this task reference to subsequent VIs for this Measurement task.



Error_out describes error conditions. If the **Error in** cluster indicated an error, the **Error_out** cluster contains the same information. Otherwise, **Error_out** describes the error status of this VI.



status is TRUE if an error occurred.



code is the error code number identifying an error. A value of 0 means success. A negative value means error: VI did not execute the intended operation. A positive value means warning: VI executed intended operation, but an informational warning is returned. For a description of the **code**, wire the error cluster to a LabVIEW error-handling VI, such as the **Simple Error Handler**.



source identifies the VI where the error occurred.

Description

If an ECU offers a reduced and specific range of DAQ list entry numbers use **MC DAQ List Initialize.vi** to setup your Measurement list. **MC DAQ List Initialize.vi** does not start the transmission of the DAQ lists from the ECU to the application or vice versa through CCP or XCP. This enables you to use **MC Set Property.vi** to change the properties of a Measurement task. After you change properties use **MC DAQ Start Stop.vi** to start the communication for the Measurement task. To query the available DAQ list entry numbers use **MC Get Property.vi** with the Poly option selection **DAQ List Numbers**.

MC DAQ Read.vi

Purpose

Reads samples from a Measurement task.

Format

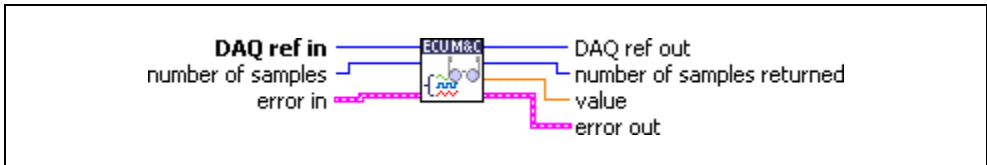

Input



DAQ ref in is the task reference from the previous Measurement task VI. The task reference is originally returned from **MC DAQ Initialize.vi**, and then wired through subsequent Measurement task VIs.



Number of samples specifies the number of samples to read for the Measurement task. For single-sample Poly VI types, **MC DAQ Read.vi** always returns one sample, so this input is ignored.



Error in is a cluster which describes error conditions occurring before the VI executes. If an error has already occurred, the VI returns the value of the **error in** cluster to **error out**.



status is TRUE if an error occurred. This VI will not execute when **status** is TRUE.



code is the error code number identifying an error. A value of 0 means success. A negative value means error: VI did not execute the intended operation. A positive value means warning: VI executed intended operation, but an informational warning is returned. For a description of the **code**, wire the error cluster to a LabVIEW error-handling VI, such as the **Simple Error Handler**.



source identifies the VI where the error occurred.

Output



DAQ ref out is the same as **DAQ ref in**. Wire the task reference to subsequent VIs for this task.



Number of samples returned indicates the number of samples returned in the samples output.



Value is a poly output that returns the samples read from the received CAN messages of the DAQ list. The type of the poly output is determined by the poly VI selection. For information on the different poly VI types provided by **MC DAQ Read.vi**, refer to the *Poly VI Types* section.

To select the data type, right-click the VI, go to **Select Type**, and select the type by name.



Error out describes error conditions. If the **Error in** cluster indicated an error, the **Error out** cluster contains the same information. Otherwise, **Error out** describes the error status of this VI.



status is `TRUE` if an error occurred.



code is the error code number identifying an error. A value of 0 means success. A negative value means error: VI did not execute the intended operation. A positive value means warning: VI executed intended operation, but an informational warning is returned. For a description of the **code**, wire the error cluster to a LabVIEW error-handling VI, such as the **Simple Error Handler**.



source identifies the VI where the error occurred.

Description

Poly VI Types

The name of each Poly VI type uses the following conventions:

- The first term is either *1Chan* or *NChan*. This indicates whether the type returns data for a single channel or multiple channels. *NChan* types return an array of analogous *1Chan* types, one entry for each channel initialized in channel list of **MC DAQ Initialize.vi**. *1Chan* types are convenient because no array indexing is required, but you are limited to reading only one channel.
- The second term is either *1Samp* or *NSamp*. This indicates whether the type returns a single sample, or an array of multiple samples. *1Samp* types are often used for single point control applications, such as within LabVIEW RT.
- The third term indicates the data type used for each sample. The type *Dbl* indicates double-precision (64-bit) floating point. The type *Wfm* indicates the waveform data type. The types *1D* and *2D* indicate one and two-dimensional arrays, respectively.

1Chan 1Samp DbI

Returns a single sample for the first channel initialized in channel list. If the initialized sample rate is greater than zero, this poly VI type waits for the next sample time, and then returns a single sample. This enables you to execute a control loop at a specific rate. If the initialized sample rate is zero, this poly VI immediately returns a single sample. The samples output returns a single sample from the most recent message received. If no message has been received since you started the task, the value of 0 is returned in samples. You can use **error out** to determine whether a new message has been received since the previous call to **MC DAQ Read.vi** (or **MC DAQ Start Stop.vi**). If no message has been received, the warning code 3FF60009 hex is returned in **error out**. If a new message has been received, the success code 0 is returned in **error out**. Unless an error occurs, **number of samples returned** is one.

NChan 1Samp 1D DbI

Returns an array, one entry for each channel initialized in channel list. Each entry consists of a single sample. The order of channel entries in samples is the same as the order in the original channel list. If the initialized sample rate is greater than zero, this poly VI type waits for the next sample time, then returns a single sample for each channel. This enables you to execute a control loop at a specific rate. If the initialized sample rate is zero, this poly VI immediately returns a single sample for each channel. The samples output returns a single sample for each channel from the most recent message received. If no message has been received for a channel since you started the task a 0 is returned in samples. You can specify channels in channel list that span multiple messages. A sample from the most recent message is returned for all channels. You can use **error out** to determine whether a new message has been received since the previous call to **MC DAQ Read.vi** (or **MC DAQ Start Stop.vi**). If no message has been received for one or more channels, the warning code 3FF60009 hex is returned in **error out**. If a new message has been received for all channels, the success code 0 is returned in **error out**. Unless an error occurs, **number of samples returned** is one. The samples array is indexed by channel, and the entry for each channel contains a single sample. If you need to determine the number of channels in the task after initialization, get the **Number of Channels** property for the task reference.

1Chan NSamp 1D DbI

Returns an array of samples for the first channel initialized in channel list. The initialized sample rate must be greater than zero for this poly VI, because each sample in the array indicates the value of the CAN channel at a specific point in time. In other words, the sample rate specifies a virtual clock that copies the most recent value from CAN messages for each sample time. The changes in sample values from message to message enable you to view the CAN channel over time, such as for comparison with other CAN or DAQ input channels. This VI waits until all samples arrive in time before returning.

If the initialized sample rate is zero, this poly VI returns an error. If the intent is simply to read the most recent sample for a task, use the *1Chan 1Samp Dbl* type. If no message has been received since you started the task a 0 is returned in all entries of the samples array. You can use **error out** to determine whether a new message has been received since the previous call to **MC DAQ Read.vi** (or **MC DAQ Start Stop.vi**). If no message has been received, the warning code 3FF60009 hex is returned in **error out**. If a new message has been received, the success code 0 is returned in **error out**. Unless an error occurs, the **number of samples returned** is equal to **number of samples** to read.

NChan NSamp 2D Dbl

Returns an array, one entry for each channel initialized in channel list. Each entry consists of an array of **value**. The order of channel entries in **value** is the same as the order in the original channel list. The initialized sample rate must be greater than zero for this poly VI, because each sample in the array indicates the value of each CAN channel at a specific point in time. In other words, the sample rate specifies a virtual clock that copies the most recent value from CAN messages for each sample time. The changes in sample values from message to message enable you to view the CAN channels over time, such as for comparison with other CAN or DAQ input channels. This VI waits until all samples arrive in time before returning.

If the initialized sample rate is zero, this poly VI returns an error. If the intent is simply to read the most recent samples for a task, use the *NChan 1Samp 1D Dbl* type. If no message has been received for a channel since you started the task, the Default Value of the channel is returned in **value**. You can specify channels in channel list that span multiple messages. At each point in time, a sample from the most recent message is returned for all channels. You can use **error out** to determine whether a new message has been received since the previous call to **MC DAQ Read.vi** (or **MC DAQ Start Stop.vi**). If no message has been received for one or more channels, the warning code 3FF60009 hex is returned in **error out**. If a new message has been received for all channels, the success code 0 is returned in **error out**. Unless an error occurs, the **number of samples returned** is equal to **number of samples** to read. If you need to determine the number of channels in the task after initialization, get the **Number of Channels** property for the task reference.

1Chan NSamp Wfm

Returns a single waveform for the first channel initialized in *channel list*. The initialized sample rate must be greater than zero for this poly VI, because each sample in the array indicates the value of the CAN channel at a specific point in time. In other words, the sample rate specifies a virtual clock that copies the most recent value from CAN messages for each sample time. The changes in sample values from message to message enable you to view the CAN channel over time, such as for comparison with other CAN or DAQ input channels. This VI waits until all samples arrive in time before returning. The start time of a waveform indicates the time of the first CAN sample in the array. The delta time of a waveform indicates the time between each sample in the array, as determined by the original sample rate.

If the initialized sample rate is zero, this poly VI returns an error. If the intent is to simply read the most recent sample for a task, use the *1Chan 1Samp Dbl* type. If no message has been received since you started the task a 0 is returned in all entries of the **value** waveform. You can use **error out** to determine whether a new message has been received since the previous call to **MC DAQ Read.vi** (or **MC DAQ Start Stop.vi**). If no message has been received, the warning code 3FF60009 hex is returned in **error out**. If a new message has been received, the success code 0 is returned in **error out**. Unless an error occurs, the **number of samples returned** is equal to **number of samples** to read.

NChan NSamp 1D Wfm

Returns an array, one entry for each channel initialized in channel list. Each entry consists of a single waveform. The order of channel entries in **value** is the same as the order in the original channel list. The initialized sample rate must be greater than zero for this poly VI, because each sample in the array of a waveform indicates the value of the CAN channel at a specific point in time. In other words, the sample rate specifies a virtual clock that copies the most recent value from CAN messages for each sample time. The changes in sample values from message to message enable you to view the M&C DAQ channel over time, such as for comparison with other CAN or DAQ input channels. This VI waits until all samples arrive in time before returning. The start time for each waveform indicates the time of the first CAN sample in the array. The delta time of a waveform indicates the time between each sample in the array, as determined by the original sample rate.

If the initialized sample rate is zero, this poly VI returns an error. If the intent is simply to read the most recent samples for a task, use the *NChan 1Samp 1D Dbl* type. If no message has been received for a channel since you started the task a 0 is returned in **value**. You can specify channels in channel list that span multiple messages. At each point in time, a sample from the most recent message is returned for all channels. You can use **error out** to determine whether a new message has been received since the previous call to **MC DAQ Read.vi** (or **MC DAQ Start Stop.vi**). If no message has been received for one or more channels, the warning code 3FF60009 hex is returned in **error out**. If a new message has been received for all channels, the success code 0 is returned in **error out**. Unless an error occurs, the **number of samples returned** is equal to **number of samples** to read. If you need to determine the number of channels in the task after initialization, get the **Number of Channels** property for the task reference.

MC Read Multi Chan Multi Samp 2D Time & Dbl

Returns an array with one entry for each channel initialized in the measurement list. Each entry consists of an array of clusters. Each cluster corresponds to a received signal for the channels initialized in the measurement list. Each cluster contains the sample value and a timestamp that indicates when the measurement channel was received. The order of channel entries in samples is the same as the order in the original channel list. To use this type, you must set the initialized mode to timestamped read. The VI does not wait for messages, but instead returns samples from the messages received since the previous call to **CAN Read.vi**.

The number of samples returned is indicated in the **number of samples returned** output, up to a maximum of **number of samples** to read messages. If no new message has been received, the **number of samples returned** is 0, and **error out** indicates success.

Because the timing of values in samples is determined by when the message is received, the **sample rate** input is not used with this poly VI type. To determine the number of channels in the task after initialization, get the **Number of Channels** property for the task reference.

MC DAQ Start Stop.vi

Purpose

Starts or stops transmission of the DAQ lists for the specified Measurement task.

Format

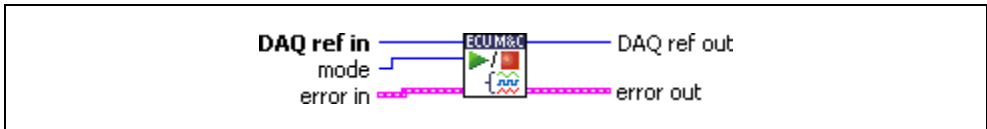

Input



DAQ ref in is the task reference from the previous Measurement task VI. The task reference is originally returned from [MC DAQ Initialize.vi](#), and then wired through subsequent Measurement task VIs.



mode indicates the type of function to be performed.

Stop DAQ List

Configures the ECU to stop transmitting a DAQ task. If stopped, properties of the DAQ task can be changed using [MC Set Property.vi](#). This function is performed automatically before [MC DAQ Clear.vi](#).

Start DAQ List

Configures the ECU to start sending data for a DAQ task. Ensure that the DAQ list has not yet been transferred to the ECU first. Once started, properties of the DAQ list can no longer be changed using [MC Set Property.vi](#). This function is performed automatically before the first read of the DAQ list with [MC DAQ Read.vi](#).

Transmit DAQ List to ECU

Transfers the DAQ list to the ECU, but does not start it. For example, use this mode if you want to change the session status before starting the DAQ list. For some ECUs this is necessary.



Error in is a cluster which describes error conditions occurring before the VI executes. If an error has already occurred, the VI returns the value of the **error in** cluster to **error out**.



status is TRUE if an error occurred. This VI will not execute when **status** is TRUE.



code is the error code number identifying an error. A value of 0 means success. A negative value means error: VI did not execute the intended operation. A positive value means warning: VI executed intended operation, but an informational warning is returned. For a description of the **code**, wire the error cluster to a LabVIEW error-handling VI, such as the **Simple Error Handler**.



source identifies the VI where the error occurred.

Output



DAQ ref out is the same as **DAQ ref in**. Wire the task reference to subsequent VIs for this task.



Error out describes error conditions. If the **Error in** cluster indicated an error, the **Error out** cluster contains the same information. Otherwise, **Error out** describes the error status of this VI.



status is `TRUE` if an error occurred.



code is the error code number identifying an error. A value of 0 means success. A negative value means error: VI did not execute the intended operation. A positive value means warning: VI executed intended operation, but an informational warning is returned. For a description of the **code**, wire the error cluster to a LabVIEW error-handling VI, such as the **Simple Error Handler**.



source identifies the VI where the error occurred.

Description

MC DAQ Start Stop.vi is optional to start or stop transmission of the DAQ lists for an M&C Measurement task to use **MC DAQ Read.vi**. If you do not specify **MC DAQ Start Stop.vi** (Start DAQ list) before your first Read VI, it is implicitly performed by the first **MC DAQ Read.vi** call.

After you start the transmission of the DAQ lists, you can no longer change the configuration of the task with **MC Set Property.vi**. You must call **MC DAQ Start Stop.vi** (Stop DAQ list) first.

MC DAQ Write.vi

Purpose

Writes samples to an ECU DAQ list.

Format

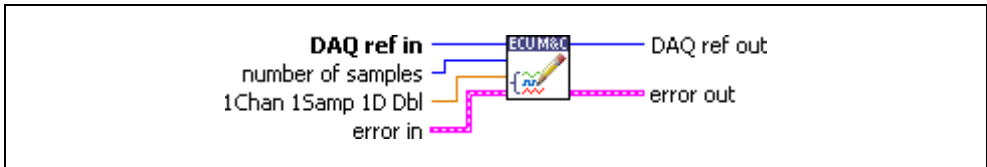

Input



DAQ ref in is the task reference from the previous Measurement task VI. The task reference is originally returned from **MC DAQ Initialize.vi**, and then wired through subsequent Measurement task VIs.



Number of samples specifies the number of samples to write for the Measurement task. For single-sample Poly VI types, **MC DAQ Write.vi** always returns one sample, so this input is ignored.



Value is a poly output that writes samples to the ECU STIM list. The type of the poly output is determined by the poly VI selection. For information on the different poly VI types provided by **MC DAQ Write.vi**, refer to the [Poly VI Types](#) section.

To select the data type, right-click the VI, go to **Select Type**, and select the type by name.



Error in is a cluster which describes error conditions occurring before the VI executes. If an error has already occurred, the VI returns the value of the **error in** cluster to **error out**.



status is TRUE if an error occurred. This VI will not execute when **status** is TRUE.



code is the error code number identifying an error. A value of 0 means success. A negative value means error: VI did not execute the intended operation. A positive value means warning: VI executed intended operation, but an informational warning is returned. For a description of the **code**, wire the error cluster to a LabVIEW error-handling VI, such as the **Simple Error Handler**.



source identifies the VI where the error occurred.

Output



DAQ ref out is the same as **DAQ ref in**. Wire the task reference to subsequent VIs for this task.



Error out describes error conditions. If the **Error in** cluster indicated an error, the **Error out** cluster contains the same information. Otherwise, **Error out** describes the error status of this VI.



status is **TRUE** if an error occurred.



code is the error code number identifying an error. A value of 0 means success. A negative value means error: VI did not execute the intended operation. A positive value means warning: VI executed intended operation, but an informational warning is returned. For a description of the **code**, wire the error cluster to a LabVIEW error-handling VI, such as the **Simple Error Handler**.



source identifies the VI where the error occurred.

Description

Poly VI Types

The name of each Poly VI type uses the following conventions:

- The first term is either *IChan* or *NChan*. This indicates whether the type writes data to a single channel or multiple channels. *NChan* types write an array of analogous *IChan* types, one entry for each channel initialized in channel list of **MC DAQ Initialize.vi**. *IChan* types are convenient because no array indexing is required, but you are limited to writing only one channel.
- The second term is either *ISamp* or *NSamp*. This indicates whether the type writes a single sample, or an array of multiple samples. *ISamp* types are often used for single point control applications, such as within LabVIEW RT.
- The third term indicates the data type used for each sample. The type *Dbl* indicates double-precision (64-bit) floating point. The type *Wfm* indicates the waveform data type. The types *1D* and *2D* indicate one and two-dimensional arrays, respectively.

1Chan 1Samp DbI

Writes a single sample for the first channel initialized in the channel list. If the initialized sample rate is greater than zero, this poly VI type waits for the next sample time, and then writes a single sample. This enables you to execute a control loop at a specific rate. If the initialized sample rate is zero, this poly VI immediately writes a single sample. If no message has been received since you started the task, the value of 0 is returned in samples. You can use **error out** to determine whether a new message has been received since the previous call to **MC DAQ Write.vi** (or **MC DAQ Start Stop.vi**). If no message has been received, the warning code 3FF60009 hex is returned in **error out**. If a new message has been received, the success code 0 is returned in **error out**.

NChan 1Samp 1D DbI

Writes an array, one entry for each channel initialized in the channel list. Each entry consists of a single sample. The order of channel entries in samples is the same as the order in the original channel list. If the initialized sample rate is greater than zero, this poly VI type waits for the next sample time, then writes a single sample for each channel. This enables you to execute a control loop at a specific rate. If the initialized sample rate is zero, this poly VI immediately writes a single sample for each channel. The samples output returns a single sample for each channel from the most recent message received. If no message has been received for a channel since you started the task a 0 is returned in samples. You can specify channels in channel list that span multiple messages. A sample from the most recent message is returned for all channels. You can use **error out** to determine whether a new message has been received since the previous call to **MC DAQ Write.vi** (or **MC DAQ Start Stop.vi**). If no message has been received for one or more channels, the warning code 3FF60009 hex is returned in **error out**. If a new message has been received for all channels, the success code 0 is returned in **error out**. Unless an error occurs, **number of samples returned** is one. The **samples** array is indexed by channel, and the entry for each channel contains a single sample. If you need to determine the number of channels in the task after initialization, get the **Number of Channels** property for the task reference.

MC Database Close.vi

Purpose

Closes a specified A2L Database.

Format

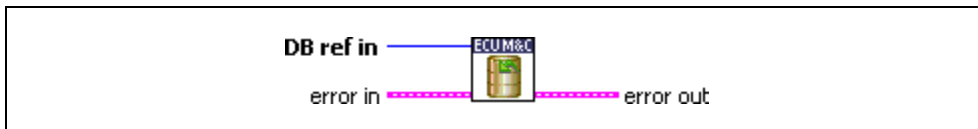

Input



DB reference in is the task reference from the initial database task VI. The task reference is originally returned from **MC Database Open.vi**.



Error in is a cluster which describes error conditions occurring before the VI executes. If an error has already occurred, the VI returns the value of the **error in** cluster to **error out**.



status is TRUE if an error occurred. Unlike other VIs, this VI will execute when **status** is TRUE.



code is the error code number identifying an error. A value of 0 means success. A negative value means error: VI did not execute the intended operation. A positive value means warning: VI executed intended operation, but an informational warning is returned. For a description of the **code**, wire the error cluster to a LabVIEW error-handling VI, such as the **Simple Error Handler**.



source identifies the VI where the error occurred.

Output



Error out describes error conditions. If the **Error in** cluster indicated an error, the **Error out** cluster contains the same information. Otherwise, **Error out** describes the error status of this VI.



status is TRUE if an error occurred.



code is the error code number identifying an error. A value of 0 means success. A negative value means error: VI did not execute the intended operation. A positive value means warning: VI executed intended operation, but an informational warning is returned. For a description of the **code**, wire the error cluster to a LabVIEW error-handling VI, such as the **Simple Error Handler**.



source identifies the VI where the error occurred.

Description

MC Database Close.vi must always be the final M&C VI called for each communication task. If you do not use **MC Database Close.vi**, the remaining task configurations can cause problems in the execution of subsequent Measurement and Calibration applications.

MC Database Close.vi is an advanced function for database handling. In most cases it is sufficient to use **MC ECU Close.vi** instead.

Unlike other VIs, **MC Database Close.vi** will execute when status is `TRUE` in **Error in**. Because this VI clears the task, the task reference is not wired as an output.

MC Database Open.vi

Purpose

Opens a specified A2L Database.

Format

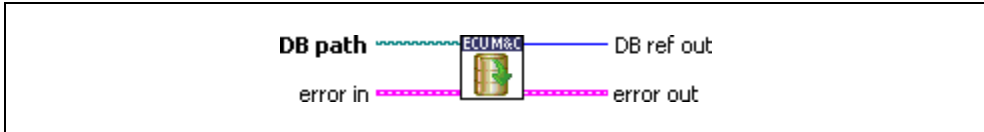

Input



DB path is a path to a A2L database file from which to get channel names. The file must use a .A2L extension. You can generate A2L database files with several 3rd party tools.



Error in is a cluster which describes error conditions occurring before the VI executes. If an error has already occurred, the VI returns the value of the **error in** cluster to **error out**.



status is TRUE if an error occurred. This VI will not execute when **status** is TRUE.



code is the error code number identifying an error. A value of 0 means success. A negative value means error: VI did not execute the intended operation. A positive value means warning: VI executed intended operation, but an informational warning is returned. For a description of the **code**, wire the error cluster to a LabVIEW error-handling VI, such as the **Simple Error Handler**.



source identifies the VI where the error occurred.

Output



DB reference out is the task reference which links to the opened database file.



Error out describes error conditions. If the **Error in** cluster indicated an error, the **Error out** cluster contains the same information. Otherwise, **Error out** describes the error status of this VI.



status is TRUE if an error occurred.



code is the error code number identifying an error. A value of 0 means success. A negative value means error: VI did not execute the intended operation. A positive value means warning: VI executed intended operation, but an informational warning is returned. For a description of the **code**, wire the error cluster to a LabVIEW error-handling VI, such as the **Simple Error Handler**.



source identifies the VI where the error occurred.

Description

Opens a specified A2L Database. **MC Database Open.vi** enables you to query all defined ECU names in the A2L Database using the **MC Get Names.vi** and selecting the property **ECU Names**. **MC Database Open.vi** does not start communication.

MC Database Open.vi is an advanced function for database handling. In most cases it is sufficient to use **MC ECU Open.vi** instead.

MC Download.vi

Purpose

Downloads data to an ECU.

Format

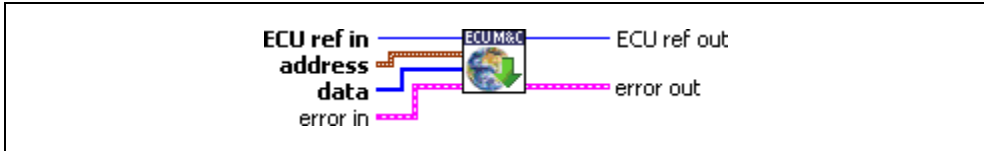

Input



ECU ref in is the task reference which links to the selected ECU. This reference is originally returned from **MC ECU Open.vi** or **MC ECU Select.vi**, and then wired through subsequent VIs.



Address is a cluster which contains the following values.



Address specifies the address part of the destination address.



Extension contains the extension part of the destination address.



Data contains the information to be downloaded.



Error in is a cluster which describes error conditions occurring before the VI executes. If an error has already occurred, the VI returns the value of the **error in** cluster to **error out**.



status is **TRUE** if an error occurred. This VI is not executed when **status** is **TRUE**.



code is the error code number identifying an error. A value of 0 means success. A negative value means error: VI did not execute the intended operation. A positive value means warning: VI executed intended operation, but an informational warning is returned. For a description of the **code**, wire the error cluster to a LabVIEW error-handling VI, such as the **Simple Error Handler**.



source identifies the VI where the error occurred.

Output



ECU ref out is the same as **ECU ref in**. Wire the task reference to subsequent VIs for this task.



Error out describes error conditions. If the **Error in** cluster indicated an error, the **Error out** cluster contains the same information. Otherwise, **Error out** describes the error status of this VI.



status is TRUE if an error occurred.



code is the error code number identifying an error. A value of 0 means success. A negative value means error: VI did not execute the intended operation. A positive value means warning: VI executed intended operation, but an informational warning is returned. For a description of the **code**, wire the error cluster to a LabVIEW error-handling VI, such as the **Simple Error Handler**.



source identifies the VI where the error occurred.

Description

MC Download.vi is used to download data to an ECU. The data is stored starting at the location specified by the **Address** and **Extension** parameters.

On XCP protocol, when the slave supports the block mode, ECU sends the data in blocks using the DOWNLOAD_NEXT command.

MC ECU Close.vi

Purpose

Closes the selected ECU and the associated A2L database.

Format

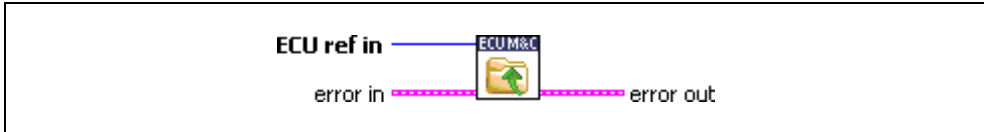

Input



ECU ref in is the task reference which links to the selected ECU. This reference is originally returned from **MC ECU Open.vi** or **MC ECU Select.vi**, and then wired through subsequent VIs.



Error in is a cluster which describes error conditions occurring before the VI executes. If an error has already occurred, the VI returns the value of the **error in** cluster to **error out**.



status is **TRUE** if an error occurred. Unlike other VIs, this VI will execute when **status** is **TRUE**.



code is the error code number identifying an error. A value of 0 means success. A negative value means error: VI did not execute the intended operation. A positive value means warning: VI executed intended operation, but an informational warning is returned. For a description of the **code**, wire the error cluster to a LabVIEW error-handling VI, such as the **Simple Error Handler**.



source identifies the VI where the error occurred.

Output



Error out describes error conditions. If the **Error in** cluster indicated an error, the **Error out** cluster contains the same information. Otherwise, **Error out** describes the error status of this VI.



status is **TRUE** if an error occurred.



code is the error code number identifying an error. A value of 0 means success. A negative value means error: VI did not execute the intended operation. A positive value means warning: VI executed intended operation, but an informational warning is returned. For a description of the **code**, wire the error cluster to a LabVIEW error-handling VI, such as the **Simple Error Handler**.



source identifies the VI where the error occurred.

Description

MC ECU Close.vi is the very last VI which must be called. It deselects the ECU and closes the remaining database reference handle. **MC ECU Close.vi** must always be the final M&C VI. If you do not use **MC ECU Close.vi**, the remaining task configurations can cause problems in the execution of subsequent M&C applications. If you just want to deselect the ECU connections, call **MC ECU Deselect.vi**.

MC ECU Connect.vi

Purpose

Establishes the communication to the selected ECU through the CCP or XCP protocol. After a successful ECU Connect you can create a Measurement Task or read/write a Characteristic.

Format

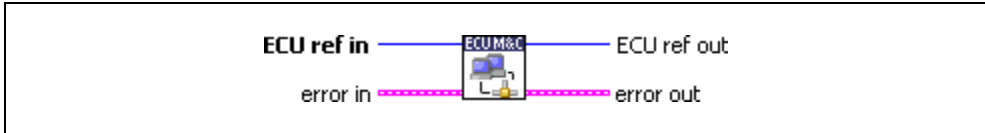

Input



ECU ref in is the task reference which links to the selected ECU. This reference is originally returned from **MC ECU Open.vi** or **MC ECU Select.vi**, and then wired through subsequent VIs.



Error in is a cluster which describes error conditions occurring before the VI executes. If an error has already occurred, the VI returns the value of the **error in** cluster to **error out**.



status is TRUE if an error occurred. This VI will not execute when **status** is TRUE.



code is the error code number identifying an error. A value of 0 means success. A negative value means error: VI did not execute the intended operation. A positive value means warning: VI executed intended operation, but an informational warning is returned. For a description of the **code**, wire the error cluster to a LabVIEW error-handling VI, such as the **Simple Error Handler**.



source identifies the VI where the error occurred.

Output



ECU ref out is the same as **ECU ref in**. Wire the task reference to subsequent VIs for this task.



Error out describes error conditions. If the **Error in** cluster indicated an error, the **Error out** cluster contains the same information. Otherwise, **Error out** describes the error status of this VI.



status is TRUE if an error occurred.



code is the error code number identifying an error. A value of 0 means success. A negative value means error: VI did not execute the intended operation. A positive value means warning: VI executed intended operation, but an informational warning is returned. For a description of the **code**, wire the error cluster to a LabVIEW error-handling VI, such as the **Simple Error Handler**.



source identifies the VI where the error occurred.

Description

If you are using the CCP protocol, **MC ECU Connect.vi** implements the CCP CONNECT command. If you are using the XCP protocol, **MC ECU Connect.vi** implements the XCP command CONNECT. It establishes a logical connection to an ECU, using the provided ECU Reference handle. Unless a slave device (ECU) is disconnected, it must not execute or respond to any command sent by the application. Only one CCP slave can be connected to the application at a time from a set of CCP slaves sharing identical CRO and DTO identifiers.

MC ECU Connect.vi is an optional function and is automatically performed before **MC Characteristic Read.vi**, **MC Characteristic Write.vi**, **MC DAQ Initialize.vi**, any MC CCP *xxx* command, or any MC XCP *xxx* command is performed.

MC ECU Create.vi

Purpose

Creates an ECU object in memory.

Format

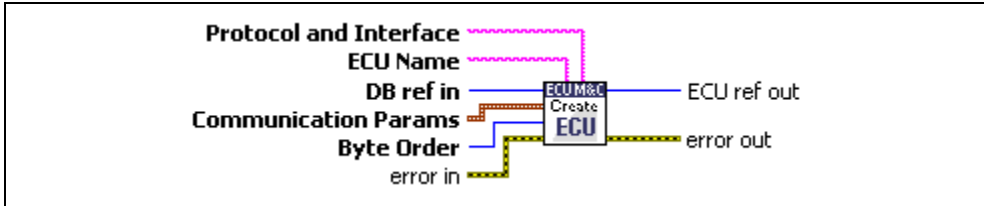

Input



Protocol and Interface selects target communication protocol CCP or XCP and the desired interface to use for this task. The interface input uses a string *xxx:yyy*, where *xxx* defines one of the two available protocols, CCP or XCP, and *yyy* defines the desired interface to use, such as CAN0 for CCP, or XCP, UDP, or TCP for XCP. The protocol and interface input is required, as this parameter is not defined in the A2L database. The default baud rate for CCP or XCP on CAN, or the IP address for XCP on UDP/TCP, may be defined in the A2L database, but you can change it by setting the Interface Baud Rate or IP Address property with [MC Set Property.vi](#).

NI-CAN

The special CAN interface values 256 and 257 refer to virtual interfaces. For more information about using virtual interfaces, refer to the *Frame to Channel Conversion* section of Chapter 6, *Using The Channel API*, in the *NI-CAN Hardware and Software User Manual*.

NI-XNET

By default, the ECU Measurement and Calibration Toolkit uses NI-CAN for CAN communication. This means you must define an NI-CAN interface for your NI-XNET hardware (NI-CAN compatibility mode) to use your XNET hardware for CAN communication. However, to use your NI-XNET interface in the native NI-XNET mode (meaning it does not use the NI-XNET Compatibility Layer), you must define your interface under **NI-XNET Devices** in MAX and pass the NI-XNET interface name that the ECU Measurement and Calibration Toolkit will use. To do this, add `@ni_genie_nixnet` to the **Protocol and Interface** string (for example,

CCP:CAN1@ni_genie_nixnet). The interface name is related to the NI-XNET hardware naming under **Devices and Interfaces** in MAX.

CompactRIO or R Series

If using CompactRIO or R Series hardware, you must provide a bitfile that handles the CAN communication between the host system and FPGA. To access the CAN module on the FPGA, you must specify the bitfile name after the @ (for example, *CCP:CAN1@MyBitfile.lvbitx*). To specify a special RIO target, you can specify that target by its name followed by the bitfile name (for example, *XCP:CAN1@RIO1,MyBitfile.lvbitx*). Currently, only a single CAN interface is supported. *RIO1* defines the RIO target name as defined in your LabVIEW Project definition. The *lvbitx* filename represents the filename and location of the bitfile on the host if using RIO or on a CompactRIO target. This implies that you must download the bitfile to the CompactRIO target before you can run your application. You may specify an absolute path or a path relative to the root of your target for the bitfile.



ECU Name sets the ECU object name. For all related ECU functions such as [MC ECU Select.vi](#), use this name as reference.



DB ref in is the task reference that links to the opened database file.



Communication Params is a cluster that contains the following values.



CRO ID sets the CAN identifier for the Command Receive Object (CRO) ID, which sends commands and data from the host to the slave device.



DTO ID sets the Data Transmission Object (DTO) ID, which the ECU uses to respond to CCP commands and send data and status information to the CCP master application.



Baud rate sets the baud rate in use by the selected CAN interface. This property applies to all tasks initialized with the NI-CAN interface. You can specify the following basic baud rates as the numeric rate: 33333, 83333, 100000, 125000, 200000, 250000, 400000, 500000, 800000, and 1000000. You can specify the advanced baud rate as 8000XXYY hex, where YY is the value of Bit Timing Register 0 (BTR0), and XX is the value of Bit Timing Register 1 (BTR1).



Station Address sets the slave device station address. A CCP address is based on the idea that several ECUs can share the same CAN Arbitration IDs for CCP communication. To avoid communication conflicts, CCP defines a station address that must be unique for all ECUs sharing the same CAN Arbitration IDs.

Unless an ECU has been addressed by its station address, the ECU must not react to CCP commands sent by the CCP master.



Byte Order sets the byte order of the CCP slave device.

0—MSB_LAST

The CCP slave device uses the MSB_LAST (Intel) byte ordering.

1—MSB_FIRST

The CCP slave device uses the MSB_FIRST (Motorola) byte ordering.



Error in is a cluster which describes error conditions occurring before the VI executes. If an error has already occurred, the VI returns the value of the **error in** cluster to **error out**.



status is TRUE if an error occurred. This VI will not execute when **status** is TRUE.



code is the error code number identifying an error. A value of 0 means success. A negative value means error: VI did not execute the intended operation. A positive value means warning: VI executed intended operation, but an informational warning is returned. For a description of the **code**, wire the error cluster to a LabVIEW error-handling VI, such as the **Simple Error Handler**.



source identifies the VI where the error occurred.

Output



ECU ref out is the task reference that links to the selected ECU.



Error out describes error conditions. If the **Error in** cluster indicated an error, the **Error out** cluster contains the same information. Otherwise, **Error out** describes the error status of this VI.



status is TRUE if an error occurred.



code is the error code number identifying an error. A value of 0 means success. A negative value means error: VI did not execute the intended operation. A positive value means warning: VI executed intended operation, but an informational warning is returned. For a description of the **code**, wire the error cluster to a LabVIEW error-handling VI, such as the **Simple Error Handler**.



source identifies the VI where the error occurred.

Description

Use **MC ECU Create.vi** to create an ECU object in memory instead of referring to an ECU object defined in the A2L database. **MC ECU Create.vi** provides an alternative in which you create the ECU and DAQ List configuration within the application, without using an A2L database. **MC ECU Create.vi** creates an ECU reference handle linked to the selected ECU name. **MC ECU Create.vi** does not start communication. This enables you to use **MC Set Property.vi** to change the properties of an ECU task and to create an event channel object manually using **MC Event Create.vi**, create a measurement object using **MC Measurement Create.vi**, and create a conversion rule using **MC Conversion Create.vi**. After you change properties, use **MC ECU Connect.vi** to start communication for the task and logically connect to the selected ECU.

MC ECU Deselect.vi

Purpose

Deselects an ECU and invalidates the ECU reference handle.

Format

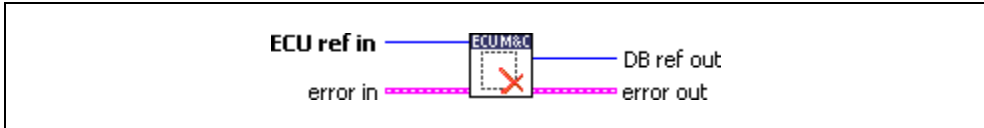

Input



ECU ref in is the task reference which links to the selected ECU. This reference is originally returned from **MC ECU Open.vi** or **MC ECU Select.vi**, and then wired through subsequent VIs.



Error in is a cluster which describes error conditions occurring before the VI executes. If an error has already occurred, the VI returns the value of the **error in** cluster to **error out**.



status is TRUE if an error occurred. Unlike other VIs, this VI will execute when **status** is TRUE.



code is the error code number identifying an error. A value of 0 means success. A negative value means error: VI did not execute the intended operation. A positive value means warning: VI executed intended operation, but an informational warning is returned. For a description of the **code**, wire the error cluster to a LabVIEW error-handling VI, such as the **Simple Error Handler**.



source identifies the VI where the error occurred.

Output



DB ref out is the task reference which links to the opened database file.



Error out describes error conditions. If the **Error in** cluster indicated an error, the **Error out** cluster contains the same information. Otherwise, **Error out** describes the error status of this VI.



status is TRUE if an error occurred.



code is the error code number identifying an error. A value of 0 means success. A negative value means error: VI did not execute the intended operation. A positive value means warning: VI executed intended operation, but an informational warning is returned. For a description of the **code**, wire the error cluster to a LabVIEW error-handling VI, such as the **Simple Error Handler**.



source identifies the VI where the error occurred.

Description

MC ECU Deselect.vi deselects the communication to the ECU. After calling this VI you can establish the communication to another ECU defined in the A2L database using **MC ECU Select.vi**.

MC ECU Disconnect.vi

Purpose

Disconnects the CCP or XCP communication to the selected ECU.

Format

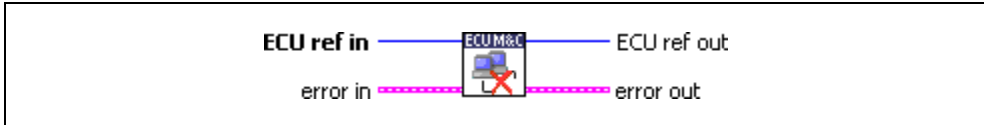

Input



ECU ref in is the task reference which links to the selected ECU. This reference is originally returned from **MC ECU Open.vi** or **MC ECU Select.vi**, and then wired through subsequent VIs.



Error in is a cluster which describes error conditions occurring before the VI executes. If an error has already occurred, the VI returns the value of the **error in** cluster to **error out**.



status is TRUE if an error occurred. This VI will not execute when **status** is TRUE.



code is the error code number identifying an error. A value of 0 means success. A negative value means error: VI did not execute the intended operation. A positive value means warning: VI executed intended operation, but an informational warning is returned. For a description of the **code**, wire the error cluster to a LabVIEW error-handling VI, such as the **Simple Error Handler**.



source identifies the VI where the error occurred.

Output



ECU ref out is the same as **ECU ref in**. Wire the task reference to subsequent VIs for this task.



Error out describes error conditions. If the **Error in** cluster indicated an error, the **Error out** cluster contains the same information. Otherwise, **Error out** describes the error status of this VI.



status is TRUE if an error occurred.



code is the error code number identifying an error. A value of 0 means success. A negative value means error: VI did not execute the intended operation. A positive value means warning: VI executed intended operation, but an informational warning is returned. For a description of the **code**, wire the error cluster to a LabVIEW error-handling VI, such as the **Simple Error Handler**.



source identifies the VI where the error occurred.

Description

MC ECU Disconnect.vi implements the CCP or XCP command DISCONNECT. **MC ECU Disconnect.vi** permanently disconnects the specified CCP or XCP slave from the communication and ends the calibration session. When the calibration session is terminated, all DAQ lists of the device are stopped and cleared and the protection masks of the device are set to their default values.

MC ECU Disconnect.vi is an optional function and is automatically performed prior to any **MC ECU Deselect.vi** or **MC ECU Close.vi** call.

MC ECU Open.vi

Purpose

Opens a specified A2L database and selects the first ECU found in the database. If there are several ECUs stored in the A2L database use the Database Open and ECU Select VIs.

Format

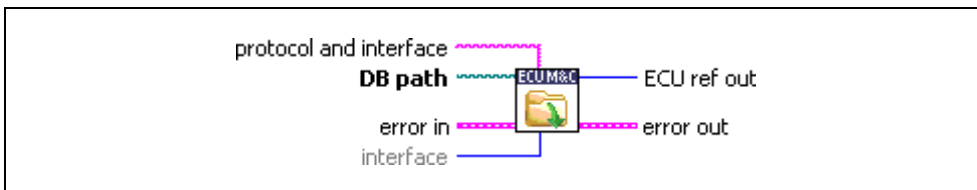

Input



protocol and interface selects target communication protocol CCP or XCP and the desired interface to use for this task. The interface input uses a string `xxx:yyy` where `xxx` defines one of the two available protocols “CCP” or “XCP” and `yyy` defines the desired interface to use like “CAN0” for CCP or XCP or “UDP” or “TCP” for XCP. The **protocol and interface** input is required as this parameter is not defined in the A2L database.

The default baud rate for CCP or XCP on CAN, or the IP address for XCP on UDP/TCP, may be defined in the A2L database, but you can change it by setting the **Interface Baud Rate** or **IP Address** property with [MC Set Property.vi](#).

NI-CAN

The special CAN interface values 256 and 257 refer to virtual interfaces. For more information on usage of virtual interfaces, refer to the *Frame to Channel Conversion* section of Chapter 6, *Using The Channel API*, in the *NI-CAN Hardware and Software User Manual*.

NI-XNET

If you use NI-XNET hardware and select the `xxx:yyy` syntax, the ECU M&C Toolkit uses the XNET NI-CAN compatibility library (XCL) internally if the XNET interface is defined in MAX under **NI-CAN Devices**. To force use of the native XNET API, you must use the `xxx:yyy@ni_genie_nixnet` syntax. The interface name is related to the NI-XNET hardware naming under **Devices and Interfaces** in MAX.

CompactRIO or R Series

If using CompactRIO or R Series hardware, you must provide a bitfile that handles the CAN communication between the host system and FPGA. To access the CAN module on the FPGA, you must specify the bitfile name after the @ (for example, *CCP:CAN1@MyBitfile.lvbitx*). To specify a special RIO target, you can specify that target by its name followed by the bitfile name (for example, *XCP:CAN1@RIO1,MyBitfile.lvbitx*). Currently, only a single CAN interface is supported. *RIO1* defines the RIO target name as defined in your LabVIEW Project definition. The *lvbitx* filename represents the filename and location of the bitfile on the host. You may use just the filename without the folder if the bitfile is in the same folder as the LabVIEW Project (*.lvproj).



DB path is a path to a A2L database file from which to get channel names. The file must use a .A2L extension. You can generate A2L database files with several 3rd party tools.



Error in is a cluster which describes error conditions occurring before the VI executes. If an error has already occurred, the VI returns the value of the **error in** cluster to **error out**.



status is TRUE if an error occurred. This VI will not execute when **status** is TRUE.



code is the error code number identifying an error. A value of 0 means success. A negative value means error: VI did not execute the intended operation. A positive value means warning: VI executed intended operation, but an informational warning is returned. For a description of the **code**, wire the error cluster to a LabVIEW error-handling VI, such as the **Simple Error Handler**.



source identifies the VI where the error occurred.



CAN interface specifies the CAN interface to use for this task. For compatibility reasons, if you are using the CCP protocol you can only specify the CAN interface to use for this CCP task. The interface input uses a `ring` typedef in which value 0 selects CAN0, value 1 selects CAN1, and so on. As the ECU M&C API is based on the NI-CAN Channel API, the NI-CAN Frame API cannot be used on the same CAN network interface simultaneously. If the CAN network interface is already initialized in the Frame API, this function returns an error.

If you use NI-XNET or CompactRIO/R Series hardware, use the **protocol and interface** parameter instead.

Output



ECU ref out is the task reference which links to the selected ECU.



Error out describes error conditions. If the **Error in** cluster indicated an error, the **Error out** cluster contains the same information. Otherwise, **Error out** describes the error status of this VI.



status is TRUE if an error occurred.



code is the error code number identifying an error. A value of 0 means success. A negative value means error: VI did not execute the intended operation. A positive value means warning: VI executed intended operation, but an informational warning is returned. For a description of the **code**, wire the error cluster to a LabVIEW error-handling VI, such as the **Simple Error Handler**.



source identifies the VI where the error occurred.

Description

MC ECU Open.vi opens a specified A2L database and selects the first ECU found in the database. If there are several ECUs stored in the A2L database use **MC Database Open.vi** and **MC ECU Select.vi** to select a specific ECU.

Possible selections for the **interface and protocol** parameter for the various hardware targets are as follows.

Using CAN hardware:

- **CCP:CAN0**—uses CCP on CAN interface 0
- **CCP:CAN1**—uses CCP on CAN interface 1, and so on with the form CAN_x
- **CCP:CAN256**—uses CCP on virtual CAN interface 256
- **CCP:CAN257**—uses CCP on virtual CAN interface 257
- **XCP:CAN0**—uses XCP on CAN interface 0
- **XCP:CAN1**—uses XCP on CAN interface 1, and so on with the form CAN_x
- **XCP:UDP**—uses XCP on UDP
- **XCP:TCP**—uses XCP on TCP

Using NI-XNET hardware:

- **CCP:CAN1@ni_genie_nixnet**—uses CCP on CAN interface 1
- **CCP:CAN2@ni_genie_nixnet**—uses CCP on CAN interface 2, and so on with the form CAN_x
- **XCP:CAN1@ni_genie_nixnet**—uses XCP on CAN interface 1

- **XCP:CAN1@ni_genie_nixnet**—uses XCP on CAN interface 2, and so on with the form CAN_x
- **XCP:UDP@ni_genie_nixnet**—uses XCP on UDP
- **XCP:TCP@ni_genie_nixnet**—uses XCP on TCP

Using CompactRIO or R Series:

- **CCP:CAN1@RIO1,c:\temp\MyFpgaBitfile.lvbitx**—uses CCP on named target RIO1 as compiled into the bitfile at `c:\temp\MyFpgaBitfile.lvbitx`
- **XCP:CAN1@RIO1,c:\temp\MyFpgaBitfile.lvbitx**—uses XCP on named target RIO1 as compiled into the bitfile at `c:\temp\MyFpgaBitfile.lvbitx`



Note You can download the ASAM MCD 2MC database configuration file to a LabVIEW RT target by the File Transfer Protocol (FTP). An FTP file transfer is possible within MAX. Refer to the *LabVIEW Real-Time Graphical File Transfer Utility* section of Chapter 2, *Installation and Configuration*, for instructions on performing an FTP transfer through MAX.

MC ECU Select.vi

Purpose

Selects an ECU based upon the names stored in an A2L database.

Format

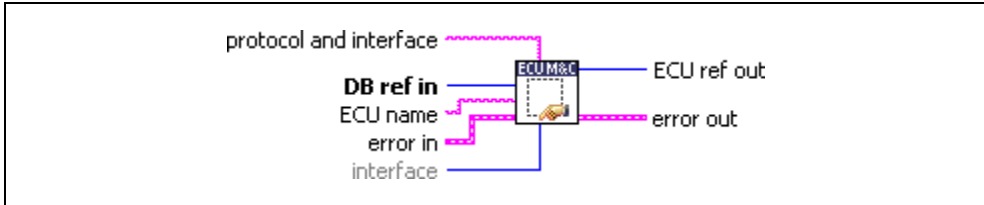

Input



protocol and interface selects target communication protocol CCP or XCP and the desired interface to use for this task. The interface input uses a string `xxx:yyy` where `xxx` defines one of the two available protocols “CCP” or “XCP” and `yyy` defines the desired interface to use like “CAN0” for CCP or XCP or “UDP” or “TCP” for XCP. The **protocol and interface** input is required as this parameter is not defined in the A2L database.

The default baud rate for CCP or XCP on CAN, or the IP address for XCP on UDP/TCP, may be defined in the A2L database, but you can change it by setting the **Interface Baud Rate** or **IP Address** property with [MC Set Property.vi](#).

NI-CAN

The special CAN interface values 256 and 257 refer to virtual interfaces. For more information about using virtual interfaces, refer to the *Frame to Channel Conversion* section of Chapter 6, *Using The Channel API*, in the *NI-CAN Hardware and Software User Manual*.

NI-XNET

If you use NI-XNET hardware and select the `xxx:yyy` syntax, the ECU M&C Toolkit uses the XNET NI-CAN compatibility library (XCL) internally if the XNET interface is defined in MAX under **NI-CAN Devices**. To force use of the native XNET API, you must use the `xxx:yyy@ni_genie_nixnet` syntax. The interface name is related to the NI-XNET hardware naming under **Devices and Interfaces** in MAX.

CompactRIO or R Series

If using CompactRIO or R Series hardware, you must provide a bitfile that handles the CAN communication between the host system and FPGA. To access the CAN module on the FPGA, you must specify the bitfile name after the @ (for example, *CCP:CAN1@MyBitfile.lvbitx*). To specify a special RIO target, you can specify that target by its name followed by the bitfile name (for example, *XCP:CAN1@RIO1,MyBitfile.lvbitx*). Currently, only a single CAN interface is supported. *RIO1* defines the RIO target name as defined in your LabVIEW Project definition. The *lvbitx* filename represents the filename and location of the bitfile on the host. You may use just the filename without the folder if the bitfile is in the same folder as the LabVIEW Project (**.lvproj*).



DB reference in is the task reference which links to the opened database file.



ECU name is the ECU name to select out of a A2L Database file, with which to initialize all subsequent tasks.



Error in is a cluster which describes error conditions occurring before the VI executes. If an error has already occurred, the VI returns the value of the **error in** cluster to **error out**.



status is TRUE if an error occurred. This VI will not execute when **status** is TRUE.



code is the error code number identifying an error. A value of 0 means success. A negative value means error: VI did not execute the intended operation. A positive value means warning: VI executed intended operation, but an informational warning is returned. For a description of the **code**, wire the error cluster to a LabVIEW error-handling VI, such as the **Simple Error Handler**.



source identifies the VI where the error occurred.



CAN interface specifies the CAN interface to use for this task. For compatibility reasons, if you are using the CCP protocol you can only specify the CAN interface to use for this CCP task. The interface input uses a ring typedef in which value 0 selects CAN0, value 1 selects CAN1, and so on. As the ECU M&C API is based on the NI-CAN Channel API, the NI-CAN Frame API cannot be used on the same CAN network interface simultaneously. If the CAN network interface is already initialized in the Frame API, this function returns an error.

Output



ECU ref out is the task reference which links to the selected ECU.



Error out describes error conditions. If the **Error in** cluster indicated an error, the **Error out** cluster contains the same information. Otherwise, **Error out** describes the error status of this VI.



status is `TRUE` if an error occurred.



code is the error code number identifying an error. A value of 0 means success. A negative value means error: VI did not execute the intended operation. A positive value means warning: VI executed intended operation, but an informational warning is returned. For a description of the **code**, wire the error cluster to a LabVIEW error-handling VI, such as the **Simple Error Handler**.



source identifies the VI where the error occurred.

Description

MC ECU Select.vi creates an ECU reference handle linked to the selected ECU name. **MC ECU Select.vi** does not start communication. This enables you to use **MC Set Property.vi** to change the properties of an ECU task. After you change properties, use **MC ECU Connect.vi** to start communication for the task and logically connect to the selected ECU. Prior to calling **MC ECU Select.vi**, an available ECU name can be queried by calling **MC Get Property.vi** with the parameter **ECU/Name**.

Possible selections for the **interface and protocol** parameter for the various hardware targets are as follows.

Using NI-CAN hardware:

- **CCP:CAN0**—uses CCP on CAN interface 0
- **CCP:CAN1**—uses CCP on CAN interface 1, and so on with the form `CANx`
- **CCP:CAN256**—uses CCP on virtual CAN interface 256
- **CCP:CAN257**—uses CCP on virtual CAN interface 257
- **XCP:CAN0**—uses XCP on CAN interface 0
- **XCP:CAN1**—uses XCP on CAN interface 1, and so on with the form `CANx`
- **XCP:UDP**—uses XCP on UDP
- **XCP:TCP**—uses XCP on TCP

Using NI-XNET hardware:

- **CCP:CAN1@ni_genie_nixnet**—uses CCP on CAN interface 1
- **CCP:CAN2@ni_genie_nixnet**—uses CCP on CAN interface 2, and so on with the form CAN_x
- **XCP:CAN1@ni_genie_nixnet**—uses XCP on CAN interface 1
- **XCP:CAN2@ni_genie_nixnet**—uses XCP on CAN interface 2, and so on with the form CAN_x
- **XCP:UDP@ni_genie_nixnet**—uses XCP on UDP
- **XCP:TCP@ni_genie_nixnet**—uses XCP on TCP

Using CompactRIO or R Series:

- **CCP:CAN1@RIO1,c:\temp\MyFpgaBitfile.lvbitx**—uses CCP on named target RIO1 as compiled into the bitfile at c:\temp\MyFpgaBitfile.lvbitx
- **XCP:CAN1@RIO1,c:\temp\MyFpgaBitfile.lvbitx**—uses XCP on named target RIO1 as compiled into the bitfile at c:\temp\MyFpgaBitfile.lvbitx

MC Event Create.vi

Purpose

Creates an Event object in memory.

Format

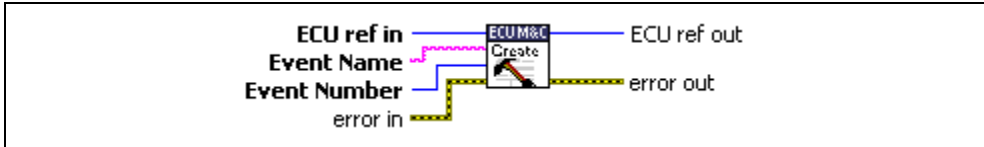

Input



ECU ref in is the task reference that links to the selected ECU. This reference is originally returned from [MC ECU Open.vi](#) or [MC ECU Create.vi](#).



Event Name identifies the event channel object. Use this name as a reference in [MC Measurement Create.vi](#) to identify the event channel.



Event Number specifies the generic signal source that effectively determines the data transmission timing. To allow a reduction of the desired transmission rate, a prescaler may be applied to the event channel. The prescaler value factor must be greater than or equal to 1 and can be set using [MC Set Property.vi](#) using the **DAQ Prescaler** property.



Error in is a cluster which describes error conditions occurring before the VI executes. If an error has already occurred, the VI returns the value of the **error in** cluster to **error out**.



status is **TRUE** if an error occurred. This VI will not execute when **status** is **TRUE**.



code is the error code number identifying an error. A value of 0 means success. A negative value means error: VI did not execute the intended operation. A positive value means warning: VI executed intended operation, but an informational warning is returned. For a description of the **code**, wire the error cluster to a LabVIEW error-handling VI, such as the **Simple Error Handler**.



source identifies the VI where the error occurred.

Output



ECU ref out is the task reference that links to the selected ECU.



Error out describes error conditions. If the **Error in** cluster indicated an error, the **Error out** cluster contains the same information. Otherwise, **Error out** describes the error status of this VI.



status is TRUE if an error occurred.



code is the error code number identifying an error. A value of 0 means success. A negative value means error: VI did not execute the intended operation. A positive value means warning: VI executed intended operation, but an informational warning is returned. For a description of the **code**, wire the error cluster to a LabVIEW error-handling VI, such as the **Simple Error Handler**.



source identifies the VI where the error occurred.

Description

Use **MC Event Create.vi** to create an Event object in memory instead of referring to a predefined measurement in the A2L database. Assign the event channel object by name to a DAQ List in **MC Measurement Create.vi**.

MC Generic.vi

Purpose

Sends a generic CCP or XCP command.

Format

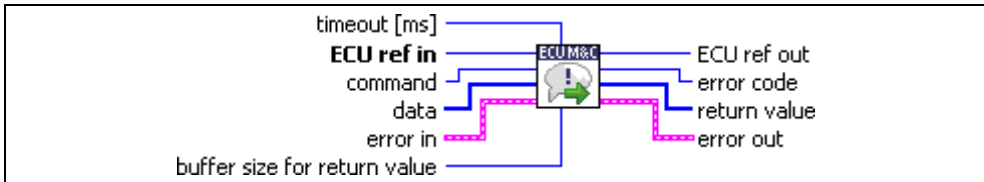

Input



Timeout is the time limit, in milliseconds, during which a specified command must complete.



ECU ref in is the task reference which links to the selected ECU. This reference is originally returned from **MC ECU Open.vi** or **MC ECU Select.vi**, and then wired through subsequent VIs.



Command is the CCP or XCP command to be sent to the ECU.



Data contains a 1-dimensional array of byte information to send to the ECU.



Buffer size for return value sets the maximum length of the **Return value** data array.



Error in is a cluster which describes error conditions occurring before the VI executes. If an error has already occurred, the VI returns the value of the **error in** cluster to **error out**.



status is **TRUE** if an error occurred. This VI is not executed when **status** is **TRUE**.



code is the error code number identifying an error. A value of 0 means success. A negative value means error: VI did not execute the intended operation. A positive value means warning: VI executed intended operation, but an informational warning is returned. For a description of the **code**, wire the error cluster to a LabVIEW error-handling VI, such as the **Simple Error Handler**.



source identifies the VI where the error occurred.

Output



ECU ref out is the same as **ECU ref in**. Wire the task reference to subsequent VIs for this task.



Error code describes the error returned from the ECU during the communication.



Return value may contain an array of bytes returned from the ECU as a response to the CCP command sent.



Error out describes error conditions. If the **Error in** cluster indicated an error, the **Error out** cluster contains the same information. Otherwise, **Error out** describes the error status of this VI.



status is TRUE if an error occurred.



code is the error code number identifying an error. A value of 0 means success. A negative value means error: VI did not execute the intended operation. A positive value means warning: VI executed intended operation, but an informational warning is returned. For a description of the **code**, wire the error cluster to a LabVIEW error-handling VI, such as the **Simple Error Handler**.



source identifies the VI where the error occurred.

Description

MC Generic.vi implements any generic CCP or XCP command that can be used to execute user-defined commands that are not defined in the CCP or XCP standard or not covered by the available LabVIEW CCP/XCP VIs.

MC Get Names.vi

Purpose

Gets an array of ECU names, Measurement names, Characteristic names, or Event names from a specified A2L database file.

Format

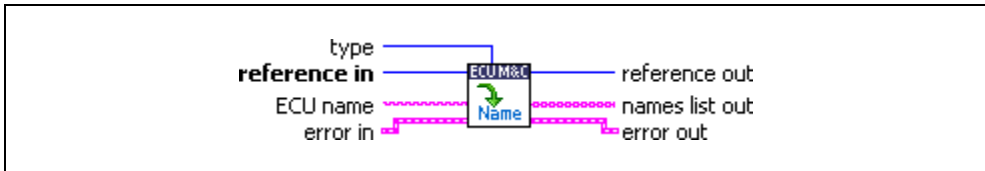

Input



Type (mode) is an input that specifies the type of names to return.

The value of **Type** (mode) is an enumeration:

0—**ECU Names** returns a list of ECU names. You can write this list to [MC ECU Select.vi](#). This is the default value.

1—**Measurement Names** returns a list of Measurement names.

2—**Characteristic Names** returns a list of Characteristic names.

3—**Event Channel Names** returns a list of Event Channel names.



Reference in must be an ECU M&C task reference or an A2L database reference.



ECU name If a valid A2L *database reference* is passed to the **reference in** terminal, the **ECU name** terminal is used to select one of the ECUs inside the A2L database. Then, **MC Get Names.vi** will report the names of all objects of the specified **type** inside the ECU, based on the name provided. If you do not provide a name, the first ECU in the A2L file is selected.



Error in is a cluster which describes error conditions occurring before the VI executes. If an error has already occurred, the VI returns the value of the **error in** cluster to **error out**.



status is TRUE if an error occurred. This VI will not execute when **status** is TRUE.



code is the error code number identifying an error. A value of 0 means success. A negative value means error: VI did not execute the intended operation. A positive value means warning: VI executed intended operation, but an informational warning is returned. For a description of the **code**, wire the error cluster to a LabVIEW error-handling VI, such as the **Simple Error Handler**.



source identifies the VI where the error occurred.

Output



Reference out is a copy of the reference which was passed to the **reference in** terminal.



Names list out returns the array of names, one string entry per name. To start a Measurement task or access a Characteristic for all channels returned from **MC Get Names.vi**, wire **channel list** to **MC DAQ Initialize.vi**.



Error out describes error conditions. If the **Error in** cluster indicated an error, the **Error out** cluster contains the same information. Otherwise, **Error out** describes the error status of this VI.



status is TRUE if an error occurred.



code is the error code number identifying an error. A value of 0 means success. A negative value means error: VI did not execute the intended operation. A positive value means warning: VI executed intended operation, but an informational warning is returned. For a description of the **code**, wire the error cluster to a LabVIEW error-handling VI, such as the **Simple Error Handler**.



source identifies the VI where the error occurred.

Description

MC Get Names.vi is used to query the names contained within an A2L file.

The **ECU name** terminal is ignored if a valid ECU reference is connected to the **reference in** terminal. In that instance, **MC Get Names.vi** will report the names of all objects of the specified **type** inside the referenced ECU.

If **type** = 1, **type** = 2, or **type** = 3, the corresponding ECU name must be referenced in order to access ECU-specific properties.

If using **MC Get Names.vi** to query the list of supported event channels on an ECU, the event channels might be stored inside the ECU instead of the A2L file. To query these event channel names from the ECU directly, connect to the ECU using **MC ECU Connect.vi** before using **MC Get Names.vi**.

MC Get Property.vi

Purpose

Gets a property for the object referenced by the **reference in** terminal. The poly VI selection determines the property to get.

Format

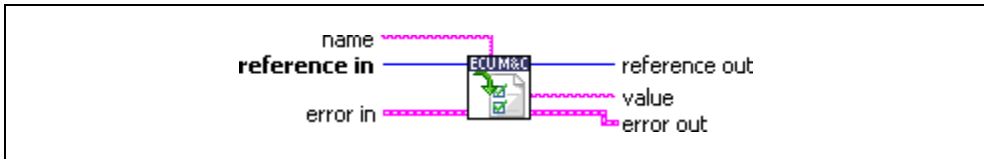

Input



Name specifies an individual channel within the task defined by **reference in**. The default (unwired) value of **name** is empty, which means the property applies to the entire task, not a specific channel. If a property relates to Measurement or Characteristic channels and does not apply to the entire task, but an individual channel or message within the task, you must wire the name of a Measurement or Characteristic channel from channel list into the **name** input. For other properties you must leave **name** unwired (empty).



Reference in is the reference to any opened A2L database, a selected ECU, or an ECU which is already connected (with [MC Database Open.vi](#), [MC ECU Select.vi](#), [MC ECU Open.vi](#), or [MC ECU Connect.vi](#)). The type of this reference depends on the property you want to get.



Error in is a cluster which describes error conditions occurring before the VI executes. If an error has already occurred, the VI returns the value of the **error in** cluster to **error out**.



status is TRUE if an error occurred. This VI will not execute when **status** is TRUE.



code is the error code number identifying an error. A value of 0 means success. A negative value means error: VI did not execute the intended operation. A positive value means warning: VI executed intended operation, but an informational warning is returned. For a description of the **code**, wire the error cluster to a LabVIEW error-handling VI, such as the **Simple Error Handler**.



source identifies the VI where the error occurred.

Output



Reference out contains an ECU M&C task reference which can be wired through subsequent ECU M&C VIs.



Value is a poly output value that returns the property value. You select the property returned in value by selecting the poly VI type. The data type of value is also determined by the poly VI selection. For information about the different properties provided by **MC Get Property.vi**, refer to the *Poly VI Types* section. To select the property, right-click the VI, go to **Select Type**, and select the property by name.



Error out describes error conditions. If the **Error in** cluster indicated an error, the **Error out** cluster contains the same information. Otherwise, **Error out** describes the error status of this VI.



status is TRUE if an error occurred.



code is the error code number identifying an error. A value of 0 means success. A negative value means error: VI did not execute the intended operation. A positive value means warning: VI executed intended operation, but an informational warning is returned. For a description of the **code**, wire the error cluster to a LabVIEW error-handling VI, such as the **Simple Error Handler**.



source identifies the VI where the error occurred.

Description

Poly VI Types

Table 5-5. Poly Values for Value Output



Type	Hierarchy	Sub-Hierarchy		Param	Description
		Sub 1	Sub 2		
	—	—	—	DB File Name	Returns the A2L Database file name with which the task has been opened. The value of this property cannot be changed using MC Set Property.vi .
	ECU	—	—	Byte Order	Returns the byte order of the CCP slave device. 0—MSB_LAST The CCP Slave device uses the MSB_LAST (Intel) byte ordering. 1—MSB_FIRST The CCP Slave device uses the MSB_FIRST (Motorola) byte ordering.
	ECU	—	—	Checksum DLL Name	Returns the file name of the Checksum DLL used for verifying the checksum.

Table 5-5. Poly Values for Value Output (Continued)



Type	Hierarchy	Sub-Hierarchy		Param	Description
		Sub 1	Sub 2		
	ECU	—	—	Command Byte Order	Returns the byte order for the defined Measurement or Characteristic: 0—MSB_LAST The CCP Slave device uses the MSB_LAST (Intel) byte ordering. 1—MSB_FIRST The CCP Slave device uses the MSB_FIRST (Motorola) byte ordering.
	ECU	—	—	Name	Returns the Name of the selected ECU opened by MC ECU Open.vi or MC ECU Select.vi .
	ECU	—	—	DAQ List Number	Returns an array of DAQ list numbers for all DAQ lists defined in the A2L file.

Table 5-5. Poly Values for Value Output (Continued)



Type	Hierarchy	Sub-Hierarchy		Param	Description
		Sub 1	Sub 2		
	ECU	CCP	—	Baud Rate	Returns the Baud Rate in use by the Interface. Basic baud rates such as 125000 and 500000 are specified as the numeric rate. Advanced baud rates are specified as 8000XXYY hex, where YY is the value of Bit Timing Register 0 (BTR0), and XX is the value of Bit Timing Register 1 (BTR1) of the CAN controller chip. For more information, refer to the Interface Properties dialog in MAX. The value of this property is originally set within MAX, but it can be changed using MC Set Property.vi .
	ECU	CCP	—	CRO ID	Returns the CRO ID (Command Receive Object) which is used to send commands and data from the host to the slave device.

Table 5-5. Poly Values for Value Output (Continued)



Type	Hierarchy	Sub-Hierarchy		Param	Description
		Sub 1	Sub 2		
	ECU	CCP	—	CRO Task	Returns the NI-CAN task reference for the CRO (Command Receive Object , the CAN task writing frames to the slave device). For example, you might use this to set CAN properties for this task. Handle with extreme care, as those properties are usually set correctly by the ECU M&C Toolkit itself.
	ECU	CCP	—	DTO ID	Returns the DTO ID (Data Transmission Object) which is used by the ECU to respond to CCP commands and send data and status information to the CCP master.
	ECU	CCP	—	DTO Task	Returns the NI-CAN task reference for the DTO ID (Data Transmission Object , the CAN task reading frames from the slave device). For example, you might use this to set CAN properties for this task. Handle with extreme care, as those properties are usually set correctly by the ECU M&C Toolkit itself.

Table 5-5. Poly Values for Value Output (Continued)





Type	Hierarchy	Sub-Hierarchy		Param	Description
		Sub 1	Sub 2		
	ECU	CCP	—	ID	Returns the slave device identifier. This ID information is optional and specific to the ECU implementation. For more information about the CCP slave ID, refer to the documentation for the ECU.
	ECU	CCP	—	ID Data Byte	Returns a data type qualifier of the slave device identifier. This ID information is optional and specific to the ECU implementation. For more information about the CCP slave ID, refer to the documentation for the ECU.
	ECU	CCP	—	Interface	Returns the interface initialized for the task, such as with MC DAQ Initialize.vi .
	ECU	CCP	—	Master ID	Returns CCP Master ID information. This ID information is optional and specific to the ECU implementation. For more information about the CCP master ID, refer to the documentation for the ECU.

Table 5-5. Poly Values for Value Output (Continued)





Type	Hierarchy	Sub-Hierarchy		Param	Description
		Sub 1	Sub 2		
	ECU	CCP	—	SeedKey Cal Name	Returns the file name of the SeedKey DLL used for Calibration purposes.
	ECU	CCP	—	SeedKey DAQ Name	Returns the file name of the SeedKey DLL used for DAQ purposes.
	ECU	CCP	—	SeedKey Prog Name	Returns the file name of the SeedKey DLL used for programming purposes.
	ECU	CCP	—	Single Byte DAQ List?	Determines if an ECU supports single-byte or multi-byte DAQ list entries.
	ECU	CCP	—	Station Address	Returns the Station Address of the slave device. CCP is based on the idea, that several ECUs can share the same CAN Arbitration IDs for CCP communication. To avoid communication conflicts CCP defines a Station Address that must be unique for all ECUs sharing the same CAN Arbitration IDs. Unless an ECU has been addressed by its Station Address, the ECU must not react to CCP commands sent by the CCP master.

Table 5-5. Poly Values for Value Output (Continued)







Type	Hierarchy	Sub-Hierarchy		Param	Description
		Sub 1	Sub 2		
	ECU	CCP	Misc	Skip EXCHANGE ID	Returns a Boolean value that indicates whether or not the EXCHANGE_ID command should be suppressed during connection to the ECU.
	ECU	CCP	Optional Commands	ACTION SERVICE	Returns a Boolean value that indicates whether the ECU supports the optional CCP Command ACTION_SERVICE.
	ECU	CCP	Optional Commands	BUILD CHECKSUM	Returns a Boolean value that indicates whether the ECU supports the optional CCP Command BUILD_CHKSUM.
	ECU	CCP	Optional Commands	CLEAR MEMORY	Returns a Boolean value that indicates whether the ECU supports the optional ASAM CCP Command CLEAR_MEMORY.
	ECU	CCP	Optional Commands	CLEAR MEMORY	Returns a Boolean value that indicates whether the ECU supports the optional CCP Command CLEAR_MEMORY.
	ECU	CCP	Optional Commands	DIAG SERVICE	Returns a Boolean value that indicates whether the ECU supports the optional CCP Command DIAG_SERVICE.

Table 5-5. Poly Values for Value Output (Continued)







Type	Hierarchy	Sub-Hierarchy		Param	Description
		Sub 1	Sub 2		
	ECU	CCP	Optional Commands	DNLOAD 6	Returns a Boolean value that indicates whether the ECU supports the optional CCP Command DNLOAD_6.
	ECU	CCP	Optional Commands	GET ACTIVE CAL PAGE	Returns a Boolean value that indicates whether the ECU supports the optional CCP Command GET_ACTIVE_CAL_PAGE.
	ECU	CCP	Optional Commands	GET S STATUS	Returns a Boolean value that indicates whether the ECU supports the optional CCP Command GET_S_STATUS.
	ECU	CCP	Optional Commands	GET SEED	Returns a Boolean value that indicates whether the ECU supports the optional CCP Command GET_SEED.
	ECU	CCP	Optional Commands	MOVE	Returns a Boolean value that indicates whether the ECU supports the optional CCP Command MOVE.
	ECU	CCP	Optional Commands	PROGRAM	Returns a Boolean value that indicates whether the ECU supports the optional CCP Command PROGRAM.

Table 5-5. Poly Values for Value Output (Continued)







Type	Hierarchy	Sub-Hierarchy		Param	Description
		Sub 1	Sub 2		
	ECU	CCP	Optional Commands	PROGRAM 6	Returns a Boolean value that indicates whether the ECU supports the optional CCP Command PROGRAM_6.
	ECU	CCP	Optional Commands	SELECT CAL PAGE	Returns a Boolean value that indicates whether the ECU supports the optional CCP Command SELECT_CAL_PAGE.
	ECU	CCP	Optional Commands	SET S STATUS	Returns a Boolean value that indicates whether the ECU supports the optional CCP Command SET_S_STATUS.
	ECU	CCP	Optional Commands	SHORT UP	Returns a Boolean value that indicates whether the ECU supports the optional CCP Command SHORT_UP.
	ECU	CCP	Optional Commands	START STOP ALL	Returns a Boolean value that indicates whether the ECU supports the optional CCP Command START_STOP_ALL.
	ECU	CCP	Optional Commands	TEST	Returns a Boolean value that indicates whether the ECU supports the optional CCP Command TEST.
	ECU	CCP	Optional Commands	UNLOCK	Returns a Boolean value that indicates whether the ECU supports the optional CCP Command UNLOCK.

Table 5-5. Poly Values for Value Output (Continued)



Type	Hierarchy	Sub-Hierarchy		Param	Description
		Sub 1	Sub 2		
	ECU	Misc	—	Timing Factor	Returns the used timing factor, which you can use to increase CCP or XCP command timeout values. For details on the default Command Timeout values, refer to the CCP or XCP Protocol Specification.
	ECU	XCP	—	Compression Method	Returns the selected compression method used for MC Program.vi . 0—data is uncompressed. 0x80...0xFF—User defined.
	ECU	XCP	—	Encryption Method	Returns the selected encryption method used for MC Program.vi . 0x00—data is not encrypted 0x80...0xFF—User defined

Table 5-5. Poly Values for Value Output (Continued)



Type	Hierarchy	Sub-Hierarchy		Param	Description
		Sub 1	Sub 2		
	ECU	XCP	—	Access Method	Returns the selected access mode: 0x00— Absolute Access Mode (default). The MTA uses physical addresses 0x01— Functional Access Mode . The MTA functions as a block sequence number of the new flash content file. 0x80...0xFF— User defined . It is possible to use different access modes for clearing and programming.
	ECU	XCP	—	Programming Method	Returns the selected programming method used for MC Program.vi . 0x00—Sequential programming, 0x80...0xFF—User defined.
	ECU	XCP	—	SeedKey DLL	Returns the file name of the SeedKey DLL.

Table 5-5. Poly Values for Value Output (Continued)



Type	Hierarchy	Sub-Hierarchy		Param	Description
		Sub 1	Sub 2		
	ECU	XCP	CAN	Baudrate	Returns the Baud Rate in use by the NI-CAN Interface. Basic baud rates such as 125000 and 500000 are specified as the numeric rate. Advanced baud rates are specified as 8000XXYY hex, where YY is the value of Bit Timing Register 0 (BTR0), and XX is the value of Bit Timing Register 1 (BTR1) of the CAN controller chip. For more information, refer to the Interface Properties dialog in MAX. The value of this property is originally set within MAX, but it can be changed using MC Set Property.vi .
	ECU	XCP	CAN	CRO Id	Returns the CRO ID (Command Receive Object) which is used to send commands and data from the host to the slave device.
	ECU	XCP	CAN	DTO Id	Returns the DTO ID (Data Transmission Object) which is used by the ECU to respond to XCP commands and send data and status information to the XCP master.

Table 5-5. Poly Values for Value Output (Continued)





Type	Hierarchy	Sub-Hierarchy		Param	Description
		Sub 1	Sub 2		
	ECU	XCP	Ethernet	IP Address	Returns the IP address of the slave device. A slave device connected by Ethernet and TCP/IP or UDP/IP protocol is addressed by its IP Address and Port number.
	ECU	XCP	Ethernet	IP Port	Returns the IP Port number of the slave device. A slave device connected by Ethernet and TCP/IP or UDP/IP protocol is addressed by its IP Address and Port number.
	Characteristic	—	—	Address	Returns the address of the selected Characteristic in the memory of the ECU.
	Characteristic	—	—	Byte Order	Returns the specified byte order: 0— Intel format Bytes are in little-endian order, with least-significant bit first. 1— Motorola format Bytes are in big-endian order, with most-significant bit first.
	Characteristic	—	—	Comment	Returns the Comment string of the selected Characteristic.

Table 5-5. Poly Values for Value Output (Continued)





Type	Hierarchy	Sub-Hierarchy		Param	Description
		Sub 1	Sub 2		
	Characteristic	—	—	Data Type	Returns the data type of the Characteristic.
	Characteristic	—	—	Dimension	Returns the dimension of a Characteristic. 0—0 dimension The Characteristic can be accessed (read/write) through a double value. 1—1 dimension The Characteristic can be accessed (read/write) through a one-dimensional array of double values. 2—2 dimensions The Characteristic can be accessed (read/write) through a two-dimensional array of double values.
	Characteristic	—	—	Extension	Returns additional address information. For instance it can be used, to distinguish different address spaces of an ECU (multi-microcontroller devices).
	Characteristic	—	—	Maximum	Returns the maximum value of the Characteristic.

Table 5-5. Poly Values for Value Output (Continued)







Type	Hierarchy	Sub-Hierarchy		Param	Description
		Sub 1	Sub 2		
	Characteristic	—	—	Minimum	Returns the minimum value of the Characteristic.
	Characteristic	—	—	Read Only?	Returns if a Characteristic is set to Read Only. In this case it is not allowed to call MC Characteristic Write.vi for this Characteristic.
	Characteristic	—	—	Sizes	Returns the array Sizes for X and Y direction of the Characteristic.
	Characteristic	—	—	Unit	Returns the unit string defined for this Characteristic in the A2L database.
	Characteristic	—	—	X Axis	Returns X-axis values on which the Characteristic is defined. It is valid if the dimension of the selected Characteristic is 1 or 2.
	Characteristic	—	—	Y Axis	Returns Y-axis values on which the Characteristic is defined. It is valid if the dimension of the selected Characteristic is 2.
	DAQ	—	—	Event Channel Name	Returns the selected event channel name to which the Measurement task is assigned.

Table 5-5. Poly Values for Value Output (Continued)

Type	Hierarchy	Sub-Hierarchy		Param	Description
		Sub 1	Sub 2		
	DAQ	—	—	Mode	<p>Returns the selected I/O mode for the M&C Measurement task.</p> <p>0—DAQ List</p> <p>The data is transmitted by the ECU based on an event channel, which can be equidistant in time or sporadic. The data can be read back with the MC DAQ Read.vi as Single point data using sample rate = 0, or as a waveform using a sample rate > 0. Input channel data is received from the DAQ messages. Use MC DAQ Read.vi to obtain input samples as single-point, array, or waveform.</p> <p>1—Polling</p> <p>In this mode the data from the Measurement task is uploaded from the ECU whenever MC DAQ Read.vi is called.</p>

Table 5-5. Poly Values for Value Output (Continued)



Type	Hierarchy	Sub-Hierarchy		Param	Description
		Sub 1	Sub 2		
	DAQ	—	—	# Channels	Returns the number of channels initialized in a DAQ channel list of a M&C Measurement task. This is the number of array entries required when using MC DAQ Read.vi .
	DAQ	—	—	Prescaler	Returns the prescaling factor which is used to reduce the desired transmission frequency of the associated DAQ list.
	DAQ	—	—	Sample Rate	Returns the selected Sample Rate in Hz for the M&C Measurement task, which may be obtained with MC DAQ Initialize.vi .

Table 5-5. Poly Values for Value Output (Continued)



Type	Hierarchy	Sub-Hierarchy		Param	Description
		Sub 1	Sub 2		
	DAQ	—	—	Samples Pending	Returns the number of samples available to be read using MC DAQ Read.vi . If you set the number of samples to read input of MC DAQ Read.vi to this value, DAQ Read returns immediately without waiting. This property applies only to tasks initialized with mode of Input and sample rate greater than zero. For all other configurations, it returns an error. If this property is queried before the DAQ list is started, it always returns zero. Start the DAQ list first with MC DAQ Start Stop.vi before you query this property.
	DAQ	CCP	—	DTO ID	Returns the DTO ID (Data Transmission Object) which is used by the ECU to send DAQ list data to the CCP master.

Table 5-5. Poly Values for Value Output (Continued)



Type	Hierarchy	Sub-Hierarchy		Param	Description
		Sub 1	Sub 2		
	DAQ	CCP	—	DTO Task	Returns the NI-CAN task reference for the DTO ID (Data Transmission Object) , the CAN task reading frames from the slave device). For example, you might use this to set CAN properties for this task. Handle with extreme care, as those properties are usually set correctly by the ECU M&C Toolkit itself.
	DAQ List	—	—	CAN ID	Returns the CAN ID for the specified DAQ list if mcPropDAQList_CANIdSelectMode == CAN_ID_FIXED.
	DAQ List	—	—	CAN ID Select Mode	Returns the condition for selecting the CAN ID for the specified DAQ list. 0—CAN_ID_FIXED The CAN Identifier is a predefined fixed number. 1—CAN_ID_VARIABLE The CAN Identifier is a variable number. 2—CAN_ID_DTO_ID The CAN Identifier is the same as the DTO identifier.

Table 5-5. Poly Values for Value Output (Continued)







Type	Hierarchy	Sub-Hierarchy		Param	Description
		Sub 1	Sub 2		
	DAQ List	—	—	Event Channels	Returns the number of allowed event channels for the specified DAQ list.
	DAQ List	—	—	Excluded DAQ Lists	Returns an array containing the numbers of DAQ lists not working together with the current DAQ list.
	DAQ List	—	—	First PID	Returns the first Packet ID for the specified DAQ list.
	DAQ List	—	—	MAX Length	Returns the maximal length of the DAQ list.
	DAQ List	—	—	Reduction Allowed	Returns whether or not the specified DAQ list allows reduction.
	Measurement	—	—	Address	Returns the address part of the address of the selected Measurement in the memory of the control unit.
	Measurement	—	—	Byte Order	Returns the specified byte order: 0— Intel format Bytes are in little-endian order, with least-significant bit first. 1— Motorola format Bytes are in big-endian order, with most-significant bit first.

Table 5-5. Poly Values for Value Output (Continued)







Type	Hierarchy	Sub-Hierarchy		Param	Description
		Sub 1	Sub 2		
	Measurement	—	—	Comment	Returns the Comment string of the selected Measurement.
	Measurement	—	—	Data Type	Returns the data type of the Measurement task.
	Measurement	—	—	Extension	Returns the extension part of the address. This optional parameter may contain additional address information defined in the A2L database. For instance, it can be used to distinguish different address spaces of an ECU (multi-microcontroller devices).
	Measurement	—	—	Is Virtual?	Indicates whether the Measurement is virtual. Virtual Measurements are not transmitted by the ECU but are calculated in the application. They return an error when opened in a DAQ list.
	Measurement	—	—	Maximum	Returns the maximum value of the Measurement.
	Measurement	—	—	Minimum	Returns the minimum value of the Measurement.

Table 5-5. Poly Values for Value Output (Continued)







Type	Hierarchy	Sub-Hierarchy		Param	Description
		Sub 1	Sub 2		
	Measurement	—	—	Read Only?	Returns <code>TRUE</code> if the selected Measurement is read only and can only be accessed through MC DAQ Read.vi , or returns <code>FALSE</code> if the Measurement can be accessed through MC Measurement Write.vi as well.
	Measurement	—	—	Unit	Returns the unit string defined for this Measurement in the A2L database.
	Version	—	—	Build	Returns the build number of the ECU M&C software. This number applies to the Development, Alpha, and Beta phases only, and should be ignored for the Release phase.
	Version	—	—	Comment	Returns a comment string for the ECU M&C software. If you received a custom release of ECU M&C from National Instruments, this comment often describes special features of the release.
	Version	—	—	Major	Returns the major version of the ECU M&C software, such as the 1 in version 1.2.5.

Table 5-5. Poly Values for Value Output (Continued)

Type	Hierarchy	Sub-Hierarchy		Param	Description
		Sub 1	Sub 2		
	Version	—	—	Minor	Returns the minor version of the ECU M&C software, such as the 2 in version 1.2.5.
	Version	—	—	Update	Returns the update version of the ECU M&C software, such as the 5 in version 1.1.5.

MC Measurement Create.vi

Purpose

Creates a Measurement object in memory.

Format

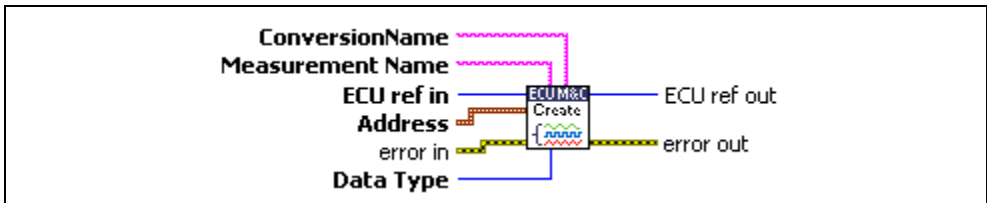

Input



Conversion Name identifies the referred conversion object defined by [MC Conversion Create.vi](#).



Measurement Name sets the measurement object name.



ECU ref in is the task reference that links to the selected ECU. This reference is originally returned from [MC ECU Open.vi](#) or [MC ECU Create.vi](#).



Address is a cluster that contains the following values:



Address specifies the address part of the source address.



Extension contains the extension part of the source address.



Error in is a cluster which describes error conditions occurring before the VI executes. If an error has already occurred, the VI returns the value of the **error in** cluster to **error out**.



status is TRUE if an error occurred. This VI will not execute when **status** is TRUE.



code is the error code number identifying an error. A value of 0 means success. A negative value means error: VI did not execute the intended operation. A positive value means warning: VI executed intended operation, but an informational warning is returned. For a description of the **code**, wire the error cluster to a LabVIEW error-handling VI, such as the [Simple Error Handler](#).



source identifies the VI where the error occurred.



Data Type sets the measurement task data type. **Data Type** can contain the following values:

Data Type	Data Format
0	Unsigned byte
1	Signed byte
2	Unsigned word
3	Signed word
4	Unsigned long
5	Signed long
6	Float 32

Output



ECU ref out is the task reference that links to the selected ECU.



Error out describes error conditions. If the **Error in** cluster indicated an error, the **Error out** cluster contains the same information. Otherwise, **Error out** describes the error status of this VI.



status is `TRUE` if an error occurred.



code is the error code number identifying an error. A value of 0 means success. A negative value means error: VI did not execute the intended operation. A positive value means warning: VI executed intended operation, but an informational warning is returned. For a description of the **code**, wire the error cluster to a LabVIEW error-handling VI, such as the **Simple Error Handler**.



source identifies the VI where the error occurred.

Description

Use **MC Measurement Create.vi** to create a measurement object in memory instead of referring to a predefined measurement in the A2L database.

MC Measurement Read.vi

Purpose

Reads a single Measurement value from the ECU.

Format

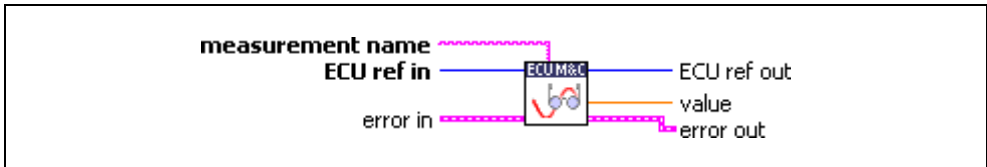

Input



Measurement name is the name of a measurement channel stored in the A2L database file you want to read.



ECU ref in is the task reference which links to the selected ECU. This reference is originally returned from [MC ECU Open.vi](#) or [MC ECU Select.vi](#), and then wired through subsequent VIs.



Error in is a cluster which describes error conditions occurring before the VI executes. If an error has already occurred, the VI returns the value of the **error in** cluster to **error out**.



status is TRUE if an error occurred. This VI will not execute when **status** is TRUE.



code is the error code number identifying an error. A value of 0 means success. A negative value means error: VI did not execute the intended operation. A positive value means warning: VI executed intended operation, but an informational warning is returned. For a description of the **code**, wire the error cluster to a LabVIEW error-handling VI, such as the [Simple Error Handler](#).



source identifies the VI where the error occurred.

Output



ECU ref out is the same as **ECU ref in**. Wire the task reference to subsequent VIs for this task.



Value returns a single sample for the Measurement channel initialized in **measurement name**.



Error out describes error conditions. If the **Error in** cluster indicated an error, the **Error out** cluster contains the same information. Otherwise, **Error out** describes the error status of this VI.



status is `TRUE` if an error occurred.



code is the error code number identifying an error. A value of 0 means success. A negative value means error: VI did not execute the intended operation. A positive value means warning: VI executed intended operation, but an informational warning is returned. For a description of the **code**, wire the error cluster to a LabVIEW error-handling VI, such as the **Simple Error Handler**.



source identifies the VI where the error occurred.

Description

MC Measurement Read.vi performs a single point read of a single Measurement from the selected ECU without opening a Measurement task.

MC Measurement Write.vi

Purpose

Writes a single Measurement value to the ECU.

Format

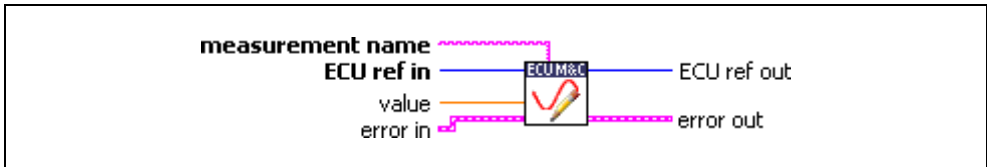

Input



Measurement name is the name of a Measurement channel stored in the A2L database file to which to write a Measurement value.



ECU ref in is the task reference which links to the selected ECU. This reference is originally returned from **MC ECU Open.vi** or **MC ECU Select.vi**, and then wired through subsequent VIs.



Value writes a single sample for the Measurement channel initialized in **measurement name**.



Error in is a cluster which describes error conditions occurring before the VI executes. If an error has already occurred, the VI returns the value of the **error in** cluster to **error out**.



status is TRUE if an error occurred. This VI will not execute when **status** is TRUE.



code is the error code number identifying an error. A value of 0 means success. A negative value means error: VI did not execute the intended operation. A positive value means warning: VI executed intended operation, but an informational warning is returned. For a description of the **code**, wire the error cluster to a LabVIEW error-handling VI, such as the **Simple Error Handler**.



source identifies the VI where the error occurred.

Output



ECU ref out is the same as **ECU ref in**. Wire the task reference to subsequent VIs for this task.



Error out describes error conditions. If the **Error in** cluster indicated an error, the **Error out** cluster contains the same information. Otherwise, **Error out** describes the error status of this VI.



status is `TRUE` if an error occurred.



code is the error code number identifying an error. A value of 0 means success. A negative value means error: VI did not execute the intended operation. A positive value means warning: VI executed intended operation, but an informational warning is returned. For a description of the **code**, wire the error cluster to a LabVIEW error-handling VI, such as the **Simple Error Handler**.



source identifies the VI where the error occurred.

Description

MC Measurement Write.vi performs a single point write of a Measurement into the selected ECU without opening a Measurement task. **MC Measurement Write.vi** can only be performed if the Measurement is not set to **read only**. To query if an ECU Measurement channel can be accessed by **MC Measurement Write.vi**, first call **MC Get Property.vi** with the parameter **Measurement/Read Only?**.

MC Program.vi

Purpose

Programs a memory block on the ECU.

Format

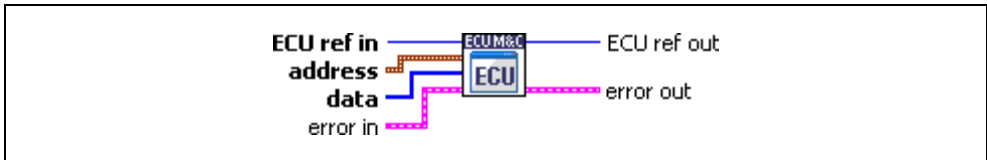

Input



ECU ref in is the task reference which links to the selected ECU. This reference is originally returned from [MC ECU Open.vi](#) or [MC ECU Select.vi](#), and then wired through subsequent VIs.



Address is a cluster which contains the following values.



Address specifies the address part of the destination address.



Extension contains the extension part of the destination address.



Data contains the byte array to be transmitted to the ECU.



Error in is a cluster which describes error conditions occurring before the VI executes. If an error has already occurred, the VI returns the value of the **error in** cluster to **error out**.



status is TRUE if an error occurred. This VI is not executed when **status** is TRUE.



code is the error code number identifying an error. A value of 0 means success. A negative value means error: VI did not execute the intended operation. A positive value means warning: VI executed intended operation, but an informational warning is returned. For a description of the **code**, wire the error cluster to a LabVIEW error-handling VI, such as the [Simple Error Handler](#).



source identifies the VI where the error occurred.

Output



ECU ref out is the same as **ECU ref in**. Wire the task reference to subsequent VIs for this task.



Error out describes error conditions. If the **Error in** cluster indicated an error, the **Error out** cluster contains the same information. Otherwise, **Error out** describes the error status of this VI.



status is `TRUE` if an error occurred.



code is the error code number identifying an error. A value of 0 means success. A negative value means error: VI did not execute the intended operation. A positive value means warning: VI executed intended operation, but an informational warning is returned. For a description of the **code**, wire the error cluster to a LabVIEW error-handling VI, such as the **Simple Error Handler**.



source identifies the VI where the error occurred.

Description

If you are using the CCP protocol, **MC Program.vi** implements the CCP command `PROGRAM`. The command is used to program the specified data into nonvolatile ECU memory (Flash, EEPROM, etc.). Programming starts at the selected MTA0 address and extension defined in the **Address** cluster.

If you are using the XCP protocol, **MC Program.vi** implements the XCP command `PROGRAM`. The command is used to program a non-volatile memory segment in the ECU slave. The end of the programming sequence is indicated by using the **MC Program Reset.vi** command which executes the XCP command `PROGRAM_RESET`. The slave device will move into a disconnected state. Usually a hardware reset of the slave device is executed. This command may support block transfer similar to the commands `DOWNLOAD` and `DOWNLOAD_NEXT`.

For further information on how to use the **MC Program.vi** and details on block mode transfers, refer to the *ASAM XCP Part 2 Protocol Layer Specification*.

MC Program Reset.vi

Purpose

Indicates the end of a programming sequence.

Format

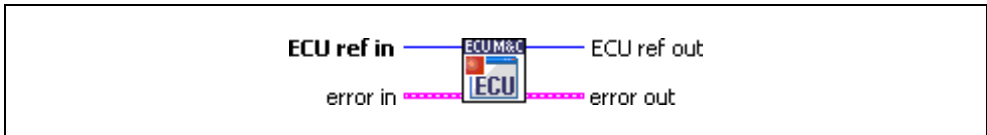

Input



ECU ref in is the task reference which links to the selected ECU. This reference is originally returned from **MC ECU Open.vi** or **MC ECU Select.vi**, and then wired through subsequent VIs.



Error in is a cluster which describes error conditions occurring before the VI executes. If an error has already occurred, the VI returns the value of the **error in** cluster to **error out**.



status is TRUE if an error occurred. This VI is not executed when **status** is TRUE.



code is the error code number identifying an error. A value of 0 means success. A negative value means error: VI did not execute the intended operation. A positive value means warning: VI executed intended operation, but an informational warning is returned. For a description of the **code**, wire the error cluster to a LabVIEW error-handling VI, such as the **Simple Error Handler**.



source identifies the VI where the error occurred.

Output



ECU ref out is the same as **ECU ref in**. Wire the task reference to subsequent VIs for this task.



Error out describes error conditions. If the **Error in** cluster indicated an error, the **Error out** cluster contains the same information. Otherwise, **Error out** describes the error status of this VI.



status is TRUE if an error occurred.



code is the error code number identifying an error. A value of 0 means success. A negative value means error: VI did not execute the intended operation. A positive value means warning: VI executed intended operation, but an informational warning is returned. For a description of the **code**, wire the error cluster to a LabVIEW error-handling VI, such as the **Simple Error Handler**.



source identifies the VI where the error occurred.

Description

If you are using the XCP protocol, **MC Program Reset.vi** implements the XCP command PROGRAM_RESET. This optional command indicates the end of a non-volatile memory programming sequence and may or may not have a response from the ECU. In either case, the slave device will go into a disconnected state.

MC Program Reset.vi may be used to reset a slave device for other purposes. For further information on how to use program ECU memory and to use the **MC Program Reset.vi** command refer to the *ASAM XCP Part 2 Protocol Layer Specification*.

MC Program Start.vi

Purpose

Indicates the start of a programming sequence.

Format

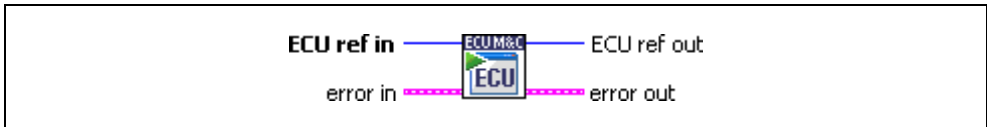

Input



ECU ref in is the task reference which links to the selected ECU. This reference is originally returned from **MC ECU Open.vi** or **MC ECU Select.vi**, and then wired through subsequent VIs.



Error in is a cluster which describes error conditions occurring before the VI executes. If an error has already occurred, the VI returns the value of the **error in** cluster to **error out**.



status is TRUE if an error occurred. This VI is not executed when **status** is TRUE.



code is the error code number identifying an error. A value of 0 means success. A negative value means error: VI did not execute the intended operation. A positive value means warning: VI executed intended operation, but an informational warning is returned. For a description of the **code**, wire the error cluster to a LabVIEW error-handling VI, such as the **Simple Error Handler**.



source identifies the VI where the error occurred.

Output



ECU ref out is the same as **ECU ref in**. Wire the task reference to subsequent VIs for this task.



Error out describes error conditions. If the **Error in** cluster indicated an error, the **Error out** cluster contains the same information. Otherwise, **Error out** describes the error status of this VI.



status is TRUE if an error occurred.



code is the error code number identifying an error. A value of 0 means success. A negative value means error: VI did not execute the intended operation. A positive value means warning: VI executed intended operation, but an informational warning is returned. For a description of the **code**, wire the error cluster to a LabVIEW error-handling VI, such as the **Simple Error Handler**.



source identifies the VI where the error occurred.

Description

If you are using the XCP protocol, **MC Program Start.vi** implements the XCP command PROGRAM_START. This optional command indicates the beginning of a programming sequence into a non-volatile memory area. If the slave device is not in a state which permits programming, an error is returned. The memory programming commands The end of a non-volatile memory programming sequence is indicated by using the **MC Program Start.vi** function.

For further information on how to use program ECU memory and to use the **MC Program Start.vi** command refer to the *ASAM XCP Part 2 Protocol Layer Specification*.

MC Set Property.vi

Purpose

Sets a property for the specified A2L database file, Measurement Task or Characteristic referenced by the **reference in** terminal. The poly VI selection determines the property to set.

Format

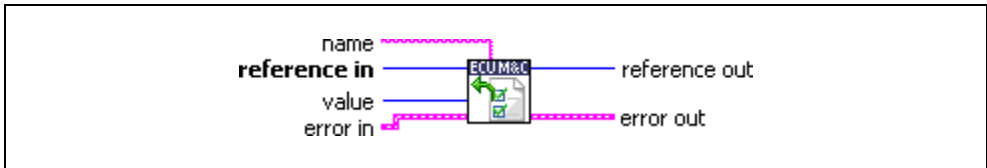

Input



Name is not used, and can be left unwired. This parameter may be used for further extensions.



Reference in specifies a valid task handle depending on the information which must be set. If a generic property must be set, a DB ref handle is needed. If a Measurement property must be set, a valid DAQ ref handle must be wired into **reference in**. If an ECU property must be set, a valid ECU ref handle must be wired into **reference in**.



Value is a poly input that specifies the property value. You select the property to set as value by selecting the poly VI type. The data type of **value** is also determined by the poly VI selection. For information on the different properties provided by **MC Set Property.vi**, refer to the [Poly VI Types](#) section. To select the property, right-click the VI, go to **Select Type** and select the property by name.



Error in is a cluster which describes error conditions occurring before the VI executes. If an error has already occurred, the VI returns the value of the **error in** cluster to **error out**.



status is TRUE if an error occurred. This VI will not execute when **status** is TRUE.



code is the error code number identifying an error. A value of 0 means success. A negative value means error: VI did not execute the intended operation. A positive value means warning: VI executed intended operation, but an informational warning is returned. For a description of the **code**, wire the error cluster to a LabVIEW error-handling VI, such as the **Simple Error Handler**.



source identifies the VI where the error occurred.

Output



Reference out is a copy of the **reference in** terminal which can be wired through subsequent ECU M&C VIs.



Error out describes error conditions. If the **Error in** cluster indicated an error, the **Error out** cluster contains the same information. Otherwise, **Error out** describes the error status of this VI.



status is `TRUE` if an error occurred.



code is the error code number identifying an error. A value of 0 means success. A negative value means error: VI did not execute the intended operation. A positive value means warning: VI executed intended operation, but an informational warning is returned. For a description of the **code**, wire the error cluster to a LabVIEW error-handling VI, such as the **Simple Error Handler**.



source identifies the VI where the error occurred.

Description

There are four types of properties which can be modified in the poly input value: ECU-specific properties, DAQ-specific properties, Characteristic-specific properties, and Measurement-specific properties.

ECU-Specific Properties

ECU-specific properties relate to the setting of the ECU. If you need to change a property of the ECU you need a valid ECU reference, but the ECU should not be connected. First, call **MC ECU Open.vi**, followed by **MC Set Property.vi** and then **MC ECU Connect.vi**. If you have already connected to the ECU, you can change an ECU property by calling **MC ECU Disconnect.vi**, followed by **MC Set Property.vi**, and then **MC ECU Connect.vi** again. Refer to Table 5-6 for a list of ECU-specific properties that can be used to define the poly input **value**.

DAQ-Specific Properties

You cannot set a property while the task is running. If you need to change a property prior to starting the task, call **MC DAQ Initialize.vi**, followed by **MC Set Property.vi** and then **MC DAQ Start Stop.vi**. After you start the task, you also can change a property by calling **MC DAQ Start Stop.vi**, followed by **MC Set Property.vi**, and then restart the task with **MC DAQ Start Stop.vi**. Refer to Table 5-7 for a list of DAQ-specific properties that can be used to define the poly input **value**.

Poly VI Types

Table 5-6. ECU-Specific Property Value Types for the POLY Input Value



Type	Hierarchy	Sub-Hierarchy		Param	Description
		Sub 1	Sub 2		
	ECU	—	—	Byte Order	Sets the byte order of the CCP slave device. 0—MSB_LAST The CCP slave device uses the MSB_LAST (Intel) byte ordering. 1—MSB_FIRST The CCP slave device uses the MSB_FIRST (Motorola) byte ordering.
	ECU	—	—	Command Byte Order	Sets the byte order of the CCP or XCP commands. 0—MSB_LAST The CCP slave device uses the MSB_LAST (Intel) byte ordering. 1—MSB_FIRST The CCP slave device uses the MSB_FIRST (Motorola) byte ordering.
	ECU	—	—	Checksum DLL Name	Sets the file name of the Checksum DLL used for verifying the checksum.

Table 5-6. ECU-Specific Property Value Types for the POLY Input Value (Continued)





Type	Hierarchy	Sub-Hierarchy		Param	Description
		Sub 1	Sub 2		
	ECU	CCP	—	Baud Rate	Sets the Baud Rate in use by the interface. This property applies to all tasks initialized with the Interface. You can specify the following basic baud rates as the numeric rate: 33333, 83333, 100000, 125000, 200000, 250000, 400000, 500000, 800000, and 1000000. You also can specify advanced baud rates in the form 8000XXYY hex, where YY is the value of Bit Timing Register 0 (BTR0), and XX is the value of Bit Timing Register 1 (BTR1).
	ECU	CCP	—	CRO ID	Sets the CRO ID (Command Receive Object) which is used to send commands and data from the host to the slave device.
	ECU	CCP	—	DTO ID	Sets the DTO ID , which is the CAN identifier for the Data Transmission Object (DTO). The DTO is used by the CCP slave devices to return data and status information to the application.
	ECU	CCP	—	Master ID	Sets the CAN identifier of the CCP master that is used by the CCP command EXCHANGE_ID as a parameter.

Table 5-6. ECU-Specific Property Value Types for the POLY Input Value (Continued)







Type	Hierarchy	Sub-Hierarchy		Param	Description
		Sub 1	Sub 2		
	ECU	CCP	—	SeedKey Cal Name	Sets the file name of the SeedKey DLL used for Calibration purposes.
	ECU	CCP	—	SeedKey DAQ Name	Sets the file name of the SeedKey DLL used for DAQ purposes.
	ECU	CCP	—	SeedKey Prog Name	Sets the file name of the SeedKey DLL used for programming purposes.
	ECU	CCP	—	Single Byte DAQ List?	Sets the ECU to support single-byte or multi-byte DAQ list entries.
	ECU	CCP	—	Station Address	Sets the Station Address of the slave device. CCP is based on the idea that several ECUs can share the same CAN Arbitration IDs for CCP communication. To avoid communication conflicts, CCP defines a Station Address that must be unique for all ECUs sharing the same CAN Arbitration IDs. Unless an ECU has been addressed by its Station Address , the ECU must not react to CCP commands sent by the CCP master.
	ECU	CCP	Misc	Skip EXCHANGE ID	Sets whether or not the CCP command EXCHANGE_ID should be suppressed during connection to the ECU.

Table 5-6. ECU-Specific Property Value Types for the POLY Input Value (Continued)









Type	Hierarchy	Sub-Hierarchy		Param	Description
		Sub 1	Sub 2		
	ECU	CCP	Optional Commands	ACTION SERVICE	Sets whether the ECU supports the optional ASAM CCP Command ACTION_SERVICE.
	ECU	CCP	Optional Commands	BUILD CHECKSUM	Sets whether the ECU supports the optional ASAM CCP Command BUILD_CHKSUM.
	ECU	CCP	Optional Commands	CLEAR MEMORY	Sets whether the ECU supports the optional ASAM CCP Command CLEAR_MEMORY.
	ECU	CCP	Optional Commands	CLEAR MEMORY	Sets whether the ECU supports the optional ASAM CCP Command CLEAR_MEMORY.
	ECU	CCP	Optional Commands	DIAG SERVICE	Sets whether the ECU supports the optional ASAM CCP Command DIAG_SERVICE.
	ECU	CCP	Optional Commands	DNLOAD 6	Sets whether the ECU supports the optional ASAM CCP Command DNLOAD_6.
	ECU	CCP	Optional Commands	GET ACTIVE CAL PAGE	Sets whether the ECU supports the optional ASAM CCP Command GET_ACTIVE_CAL_PAGE.
	ECU	CCP	Optional Commands	GET S STATUS	Sets whether the ECU supports the optional ASAM CCP Command GET_S_STATUS.

Table 5-6. ECU-Specific Property Value Types for the POLY Input Value (Continued)









Type	Hierarchy	Sub-Hierarchy		Param	Description
		Sub 1	Sub 2		
	ECU	CCP	Optional Commands	GET SEED	Sets whether the ECU supports the optional ASAM CCP Command GET_SEED.
	ECU	CCP	Optional Commands	MOVE	Sets whether the ECU supports the optional ASAM CCP Command MOVE.
	ECU	CCP	Optional Commands	PROGRAM	Sets whether the ECU supports the optional ASAM CCP Command PROGRAM.
	ECU	CCP	Optional Commands	PROGRAM 6	Sets whether the ECU supports the optional ASAM CCP Command PROGRAM_6.
	ECU	CCP	Optional Commands	SELECT CAL PAGE	Sets whether the ECU supports the optional ASAM CCP Command SELECT_CAL_PAGE.
	ECU	CCP	Optional Commands	SET S STATUS	Sets whether the ECU supports the optional ASAM CCP Command SET_S_STATUS.
	ECU	CCP	Optional Commands	SHORT UP	Sets whether the ECU supports the optional ASAM CCP Command SHORT_UP.
	ECU	CCP	Optional Commands	START STOP ALL	Sets whether the ECU supports the optional ASAM CCP Command START_STOP_ALL.

Table 5-6. ECU-Specific Property Value Types for the POLY Input Value (Continued)





Type	Hierarchy	Sub-Hierarchy		Param	Description
		Sub 1	Sub 2		
	ECU	CCP	Optional Commands	TEST	Sets whether the ECU supports the optional ASAM CCP Command TEST.
	ECU	CCP	Optional Commands	UNLOCK	Sets whether the ECU supports the optional ASAM CCP Command UNLOCK.
	ECU	Misc	—	Timing Factor	Sets the timing factor to increase the XCP or CCP Command timeouts by this value. For details on the default Command Timeout values, refer to the CCP or XCP Protocol Specification.
	ECU	XCP	—	SeedKey DLL	Sets the file name of the XCP SeedKey DLL.
	ECU	XCP	—	Access Method	Sets the selected access mode: 0x00— Absolute Access Mode (default). The MTA uses physical addresses 0x01— Functional Access Mode . The MTA functions as a block sequence number of the new flash content file. 0x80...0xFF— User defined . It is possible to use different access modes for clearing and programming.

Table 5-6. ECU-Specific Property Value Types for the POLY Input Value (Continued)





Type	Hierarchy	Sub-Hierarchy		Param	Description
		Sub 1	Sub 2		
	ECU	XCP	—	Compression Method	Sets the selected compression method used for MC Program.vi . 0—data is uncompressed. 0x80...0xFF—User defined.
	ECU	XCP	—	Encryption Method	Sets the selected encryption method used for MC Program.vi . 0x00—data is not encrypted 0x80...0xFF—User defined
	ECU	XCP	—	Programming Method	Sets the selected programming method used for MC Program.vi . 0x00—Sequential programming. 0x80...0xFF—User defined.
	ECU	XCP	CAN	Baudrate	Sets the Baud Rate in use by the NI-CAN Interface. Basic baud rates such as 125000 and 500000 are specified as the numeric rate. Advanced baud rates are specified as 8000XXYY hex, where YY is the value of Bit Timing Register 0 (BTR0), and XX is the value of Bit Timing Register 1 (BTR1) of the CAN controller chip.

Table 5-6. ECU-Specific Property Value Types for the POLY Input Value (Continued)





Type	Hierarchy	Sub-Hierarchy		Param	Description
		Sub 1	Sub 2		
	ECU	XCP	CAN	CRO Id	Sets the CRO ID (Command Receive Object) which is used to send commands and data from the host to the slave device.
	ECU	XCP	CAN	DTO Id	Sets the DTO ID (Data Transmission Object) which is used by the ECU to respond to XCP commands and send data and status information to the XCP master.
	ECU	XCP	Ethernet	IP Address	Sets the IP address of the slave device. A slave device connected by Ethernet and TCP/IP or UDP/IP protocol is addressed by its IP Address and Port number.
	ECU	XCP	Ethernet	IP Port	Sets the IP Port number of the slave device. A slave device connected by Ethernet and TCP/IP or UDP/IP protocol is addressed by its IP Address and Port number.

Table 5-7. DAQ-Specific Property Value Types for the POLY Input Value









Type	Hierarchy	Sub-Hierarchy		Param	Description
		Sub 1	Sub 2		
	DAQ	—	—	Event Channel Name	Sets the event channel name to which the Measurement task is assigned.
	DAQ	—	—	Mode	<p>Sets the selected I/O mode for the M&C Measurement task.</p> <p>0—DAQ List</p> <p>The data is transmitted from the ECU in equidistant time intervals as defined in the A2L database. The data can be read back with the MC DAQ Read.vi as Single point data using sample rate = 0, or as a waveform using a sample rate > 0. Input channel data is received from the DAQ messages. Use MC DAQ Read.vi to obtain input samples as single-point, array, or waveform.</p> <p>1—Polling</p> <p>In this mode the data from the Measurement task is uploaded from the ECU whenever MC DAQ Read.vi is called.</p>
	DAQ	—	—	Prescaler	Sets the prescaling factor, which reduces the desired transmission frequency of the associated DAQ list.

Table 5-7. DAQ-Specific Property Value Types for the POLY Input Value (Continued)

Type	Hierarchy	Sub-Hierarchy		Param	Description
		Sub 1	Sub 2		
	DAQ	—	—	Sample Rate	<p>SampleRate specifies the timing to use for the samples of the (NI-CAN) task. The sample rate is specified in Hertz (samples per second). A sample rate of zero means to sample immediately.</p> <p>For a DAQMode of mcDAQModeDAQList, SampleRate of zero means that MC DAQ Read.vi returns a single sample from the most recent messages received, and greater than zero means that MC DAQ Read.vi returns samples timed at the specified rate. For DAQMode of mcDAQModePolling, SampleRate is ignored.</p>
	DAQ	CCP	—	DTO ID	Sets the DTO ID (Data Transmission Object) which is used by the ECU to send DAQ list data to the CCP master.

Characteristic-Specific Properties

Table 5-8. Characteristic-Specific Property Value Types for the PropertyID Input Value

Type	Hierarchy	Sub-Hierarchy		Param	Description
		Sub 1	Sub 2		
	Characteristic	—	—	X Axis	Sets the X-axis values on which the Characteristic is defined. The Characteristic dimension must be at least 1.
	Characteristic	—	—	Y Axis	Sets the Y-axis values on which the Characteristic is defined. The Characteristic dimension must be 2.
	Characteristic	—	—	Byte Order	Sets the specified byte order of the entire characteristic: 0—Intel format Bytes are in little-endian order, with least-significant bit first. 1—Motorola format Bytes are in big-endian order, with most-significant bit first.

Measurement-Specific Properties

Table 5-9. Measurement-Specific Property Value Types for the PropertyID Input Value

Type	Hierarchy	Sub-Hierarchy		Param	Description
		Sub 1	Sub 2		
	Measurement	—	—	Byte Order	Sets the specified byte order of the selected Measurement: 0—Intel format Bytes are in little-endian order, with least-significant bit first. 1—Motorola format Bytes are in big-endian order, with most-significant bit first.

MC Upload.vi

Purpose

Uploads data from an ECU.

Format

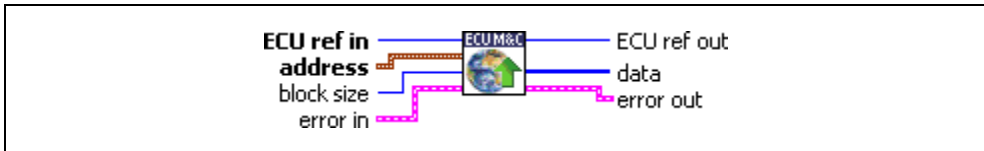

Input



ECU ref in is the task reference which links to the selected ECU. This reference is originally returned from **MC ECU Open.vi** or **MC ECU Select.vi**, and then wired through subsequent VIs.



Address is a cluster which contains the following values.



Address specifies the address part of the source address in the ECU from which the memory block is copied.



Extension specifies the extension part of the source address.



Block size is the size of the data block, in bytes, to be uploaded.



Error in is a cluster which describes error conditions occurring before the VI executes. If an error has already occurred, the VI returns the value of the **error in** cluster to **error out**.



status is **TRUE** if an error occurred. This VI is not executed when **status** is **TRUE**.



code is the error code number identifying an error. A value of 0 means success. A negative value means error: VI did not execute the intended operation. A positive value means warning: VI executed intended operation, but an informational warning is returned. For a description of the **code**, wire the error cluster to a LabVIEW error-handling VI, such as the **Simple Error Handler**.



source identifies the VI where the error occurred.

Output



ECU ref out is the same as **ECU ref in**. Wire the task reference to subsequent VIs for this task.



Data is a byte array which receives the uploaded data from the ECU.



Error out describes error conditions. If the **Error in** cluster indicated an error, the **Error out** cluster contains the same information. Otherwise, **Error out** describes the error status of this VI.



status is TRUE if an error occurred.



code is the error code number identifying an error. A value of 0 means success. A negative value means error: VI did not execute the intended operation. A positive value means warning: VI executed intended operation, but an informational warning is returned. For a description of the **code**, wire the error cluster to a LabVIEW error-handling VI, such as the **Simple Error Handler**.



source identifies the VI where the error occurred.

Description

MC Upload.vi implements the UPLOAD command. A data block of the specified length, starting at the specified address, is uploaded from the ECU. **MC Upload.vi** will set the Memory Transfer Address pointer MTA0 to the appropriate value as defined in the **Address** cluster.

If you are using the CCP protocol, **MC Upload.vi** implements the UPLOAD command. A data block of the specified length, starting at the specified address, is uploaded from the ECU. **MC Upload.vi** will set the Memory Transfer Address pointer MTA0 to the appropriate value as defined in the Address cluster.

If you are using the XCP protocol, **MC Upload.vi** implements the XCP command UPLOAD. A data block of the specified length starting at the specified address is uploaded from the ECU. The Memory Transfer Address pointer MTA0 is post-incremented by the given number of data elements. If the slave device does not support block transfer mode, all uploaded data is transferred in a single response packet. If block transfer mode is supported, the uploaded data is transferred in multiple responses on the same request packet. For the master there are no limitations allowed concerning the maximum block size.

For further information on how to upload data and to use the **MC Upload.vi** command refer to the *ASAM XCP Part 2 Protocol Layer Specification*.

MC XCP Copy Cal Page.vi

Purpose

Forces a copy transaction of one calibration page to another.

Format

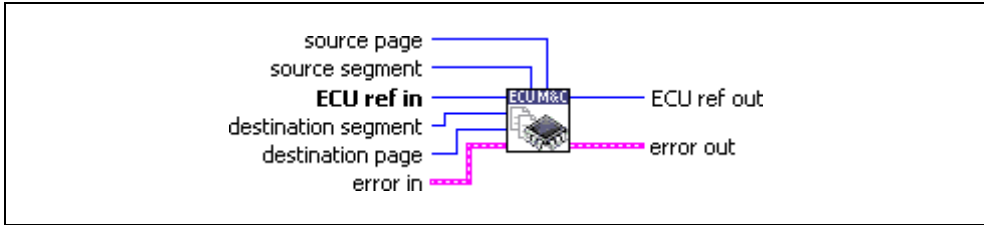

Input



Source page specifies the logical page number of the source data page.



Source segment specifies the logical segment number of the source data page.



ECU ref in is the task reference which links to the selected ECU. This reference is originally returned from [MC ECU Open.vi](#) or [MC ECU Select.vi](#), and then wired through subsequent VIs.



Destination page specifies the logical segment number of the destination data page.



Destination segment specifies logical page number of the destination data page.



Error in is a cluster which describes error conditions occurring before the VI executes. If an error has already occurred, the VI returns the value of the **error in** cluster to **error out**.



status is TRUE if an error occurred. This VI will not execute when **status** is TRUE.



code is the error code number identifying an error. A value of 0 means success. A negative value means error: VI did not execute the intended operation. A positive value means warning: VI executed intended operation, but an informational warning is returned. For a description of the **code**, wire the error cluster to a LabVIEW error-handling VI, such as the **Simple Error Handler**.



source identifies the VI where the error occurred.

Output



ECU ref out is the same as **ECU ref in**. Wire the task reference to subsequent VIs for this task.



Error out describes error conditions. If the **Error in** cluster indicated an error, the **Error out** cluster contains the same information. Otherwise, **Error out** describes the error status of this VI.



status is TRUE if an error occurred.



code is the error code number identifying an error. A value of 0 means success. A negative value means error: VI did not execute the intended operation. A positive value means warning: VI executed intended operation, but an informational warning is returned. For a description of the **code**, wire the error cluster to a LabVIEW error-handling VI, such as the **Simple Error Handler**.



source identifies the VI where the error occurred.

Description

MC XCP Copy Cal Page.vi implements the XCP command COPY_CAL_PAGE and forces the slave to copy one calibration page to another. This command is only available if more than one calibration page is defined. In principal, any page of any segment can be copied to any page of any other segment but there may be restrictions.

Refer to the *ASAM XCP Part 2 Protocol Layer Specification* for more information on how to set up a request.

MC XCP Get Cal Page.vi

Purpose

Queries a calibration page setting.

Format

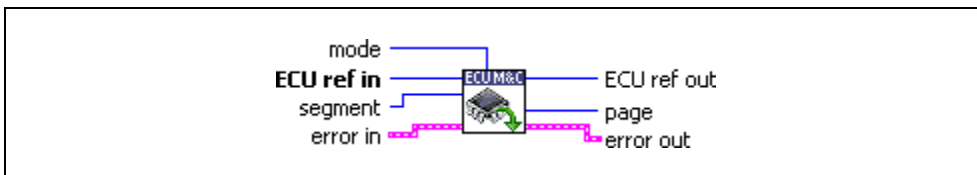

Input



Mode specifies the access mode:

Mode = 1

The given page is used by the slave device application.

Mode = 2

The slave device XCP driver will access the given page.



ECU ref in is the task reference which links to the selected ECU. This reference is originally returned from [MC ECU Open.vi](#) or [MC ECU Select.vi](#), and then wired through subsequent VIs.



Segment specifies the selected logical data segment number.



Error in is a cluster which describes error conditions occurring before the VI executes. If an error has already occurred, the VI returns the value of the **error in** cluster to **error out**.



status is `TRUE` if an error occurred. This VI will not execute when **status** is `TRUE`.



code is the error code number identifying an error. A value of 0 means success. A negative value means error: VI did not execute the intended operation. A positive value means warning: VI executed intended operation, but an informational warning is returned. For a description of the **code**, wire the error cluster to a LabVIEW error-handling VI, such as the **Simple Error Handler**.



source identifies the VI where the error occurred.

Output



ECU ref out is the same as **ECU ref in**. Wire the task reference to subsequent VIs for this task.



Page returns the logical data page number.



Error out describes error conditions. If the **Error in** cluster indicated an error, the **Error out** cluster contains the same information. Otherwise, **Error out** describes the error status of this VI.



status is TRUE if an error occurred.



code is the error code number identifying an error. A value of 0 means success. A negative value means error: VI did not execute the intended operation. A positive value means warning: VI executed intended operation, but an informational warning is returned. For a description of the **code**, wire the error cluster to a LabVIEW error-handling VI, such as the **Simple Error Handler**.



source identifies the VI where the error occurred.

Description

MC XCP Get Cal Page.vi implements the XCP command GET_CAL_PAGE and queries the logical number for the calibration data page that is currently activated for the specified access mode and data segment.

Refer to the *ASAM XCP Part 2 Protocol Layer Specification* for more information on how to set up a request.

MC XCP Get ID.vi

Purpose

Queries session configuration or slave device identification.

Format

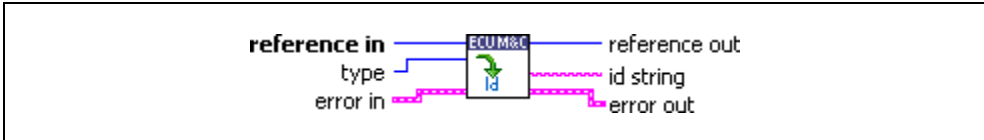

Input



Reference in is the reference to any opened A2L database, a selected ECU, or an ECU which is already connected (with **MC Database Open.vi**, **MC ECU Select.vi**, **MC ECU Open.vi**, or **MC ECU Connect.vi**). The type of this reference depends on the property you want to get.



Type specifies the type of the requested identification:

Type	Description
0	ASCII text
1	ASAM-MC2 filename without path and extension
2	ASAM-MC2 filename with path and extension
3	URL where the ASAM-MC2 file can be found
4	ASAM-MC2 file to upload
128..255	User defined



Error in is a cluster which describes error conditions occurring before the VI executes. If an error has already occurred, the VI returns the value of the **error in** cluster to **error out**.



status is TRUE if an error occurred. This VI will not execute when **status** is TRUE.



code is the error code number identifying an error. A value of 0 means success. A negative value means error: VI did not execute the intended operation. A positive value means warning: VI executed intended operation, but an informational warning is returned. For a description of the **code**, wire the error cluster to a LabVIEW error-handling VI, such as the **Simple Error Handler**.



source identifies the VI where the error occurred.

Output



Reference out is a copy of the **reference in** terminal which can be wired through subsequent ECU M&C VIs.



Id contains the queried identification string.



Error out describes error conditions. If the **Error in** cluster indicated an error, the **Error out** cluster contains the same information. Otherwise, **Error out** describes the error status of this VI.



status is TRUE if an error occurred.



code is the error code number identifying an error. A value of 0 means success. A negative value means error: VI did not execute the intended operation. A positive value means warning: VI executed intended operation, but an informational warning is returned. For a description of the **code**, wire the error cluster to a LabVIEW error-handling VI, such as the **Simple Error Handler**.



source identifies the VI where the error occurred.

Description

MC XCP Get ID.vi implements the XCP command GET_ID and returns session configuration or slave device identification information of the selected ECU slave device. The supported types are implementation specific of the ECU slave device. The identification string is ASCII text format.

MC XCP Get Status.vi

Purpose

Queries the current session status from an ECU slave device.

Format

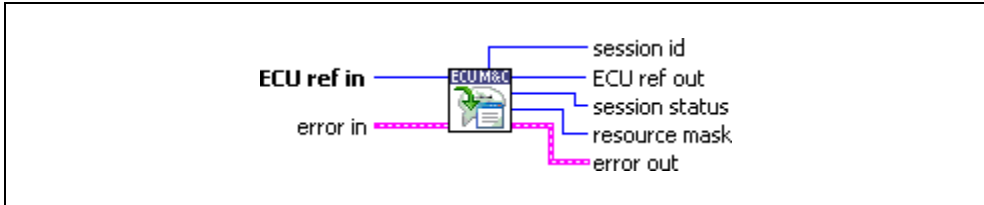

Input



ECU ref in is the task reference which links to the selected ECU. This reference is originally returned from **MC ECU Open.vi** or **MC ECU Select.vi**, and then wired through subsequent VIs.



Error in is a cluster which describes error conditions occurring before the VI executes. If an error has already occurred, the VI returns the value of the **error in** cluster to **error out**.



status is **TRUE** if an error occurred. This VI will not execute when **status** is **TRUE**.



code is the error code number identifying an error. A value of 0 means success. A negative value means error: VI did not execute the intended operation. A positive value means warning: VI executed intended operation, but an informational warning is returned. For a description of the **code**, wire the error cluster to a LabVIEW error-handling VI, such as the **Simple Error Handler**.



source identifies the VI where the error occurred.

Output



Session Id returns the defined session configuration ID.



ECU ref out is the same as **ECU ref in**. Wire the task reference to subsequent VIs for this task.



Session status returns the current status of the selected ECU.



Resource mask is the current resource protection status of the selected ECU.



Error out describes error conditions. If the **Error in** cluster indicated an error, the **Error out** cluster contains the same information. Otherwise, **Error out** describes the error status of this VI.



status is TRUE if an error occurred.



code is the error code number identifying an error. A value of 0 means success. A negative value means error: VI did not execute the intended operation. A positive value means warning: VI executed intended operation, but an informational warning is returned. For a description of the **code**, wire the error cluster to a LabVIEW error-handling VI, such as the **Simple Error Handler**.



source identifies the VI where the error occurred.

Description

MC XCP Get Status.vi implements the XCP command GET_STATUS and returns all current status information of the selected ECU slave device, including the status of the resource protection, pending store requests and the general status of data acquisition and stimulation.

Current Session Status

Session status contains a bit mask which is described below:

Bit Number	Flag	Description
0	STORE_CAL_REQ	REQuest to STORE CALibration data: 0—STORE_CAL_REQ mode is reset. 1—STORE_CAL_REQ mode is set.
1	Unused	—
2	STORE_DAQ_REQ	REQuest to STORE DAQ list: 0—STORE_DAQ_REQ mode is reset. 1—STORE_DAQ_REQ mode is set.

Bit Number	Flag	Description
3	CLEAR_DAQ_REQ	REqUest to CLEAR DAQ configuration: 0—CLEAR_DAQ_REQ is reset. 1—CLEAR_DAQ_REQ is set.
4	Unused	—
5	Unused	—
6	DAQ_RUNNING	Data Transfer: 0—The data transfer is not running. 1—The data transfer is running.
7	RESUME	RESUME Mode: 0—The slave device is not in RESUME mode. 1—The slave device is in RESUME mode.

The STORE_CAL_REQ flag indicates a pending request to save the calibration data into non-volatile memory. As soon as the request has been fulfilled, the slave will reset the appropriate bit. The slave device may indicate this by transmitting an EV_STORE_CAL event packet.

The STORE_DAQ_REQ flag indicates a pending request to save the DAQ list setup in non-volatile memory. As soon as the request has been fulfilled, the slave will reset the appropriate bit. The slave device may indicate this by transmitting an EV_STORE_DAQ event packet.

The CLEAR_DAQ_REQ flag indicates a pending request to clear all DAQ lists in non-volatile memory. All ODT entries are reset to address = 0, extension = 0, size = 0 and bit_offset = FF. Session configuration ID is reset to 0. As soon as the request has been fulfilled, the slave will reset the appropriate bit. The slave device may indicate this by transmitting an EV_CLEAR_DAQ event packet. If the slave device does not support the requested mode, an ERR_OUT_OF_RANGE is returned.

The DAQ_RUNNING flag indicates that at least one DAQ list has been started and is in RUNNING mode.

The RESUME flag indicates that the slave is in RESUME mode.

Resource mask contains the current resource protection status as a bit mask described below:

Bit Number	Flag	Description
0	CAL/PAG	REQuest to STORE CALibration data: 0—STORE_CAL_REQ mode is reset. 1—STORE_CAL_REQ mode is set.
1	Unused	—
2	DAQ	DAQ list commands (DIRECTION = DAQ): 0—DAQ list commands are not protected with SEED & Key mechanism. 1—DAQ list commands are protected with SEED & Key mechanism.
3	STIM	DAQ list commands (DIRECTION = STIM): 0—DAQ list commands are not protected with SEED & Key mechanism. 1—DAQ list commands are protected with SEED & Key mechanism.
4	PGM	ProGraMming commands: 0—ProGraMming commands are not protected with SEED & Key mechanism. 1—ProGraMming commands are protected with SEED & Key mechanism
5	Unused	—
6	Unused	—
7	Unused	—

The CAL/PAG flags indicates that all commands of the CALibration/PAGing group are protected and will return an `ERR_ACCESS_LOCKED` upon an attempt to execute the command without a previous successful `GET_SEED/UNLOCK` sequence.

The PGM flags indicates that all the commands of the ProGraMming group are protected and will return a `ERR_ACCESS_LOCKED` upon an attempt to execute the command without a previous successful `GET_SEED/UNLOCK` sequence.

The parameter **Session Id** contains the Session configuration ID. The session configuration ID must be set by a prior **MC XCP Set Request.vi** call with **STORE_DAQ_REQ** set. This allows the master device to verify that automatically started DAQ lists contain the expected data transfer configuration.

MC XCP Program Prepare.vi

Purpose

Prepares the programming of non volatile memory.

Format

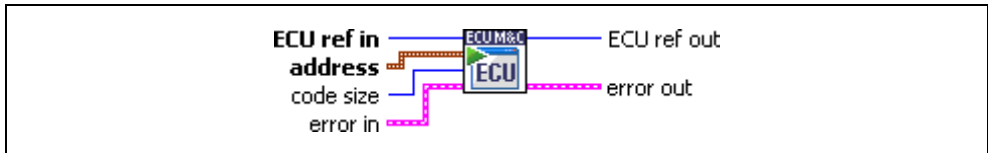

Input



ECU ref in is the task reference which links to the selected ECU. This reference is originally returned from **MC ECU Open.vi** or **MC ECU Select.vi**, and then wired through subsequent VIs.



Address is a cluster which contains the following values.



Address specifies the address part of the source address.



Extension contains the extension part of the source address.



Code size determines the size of data code to be downloaded by the subsequent memory programming.



Error in is a cluster which describes error conditions occurring before the VI executes. If an error has already occurred, the VI returns the value of the **error in** cluster to **error out**.



status is TRUE if an error occurred. This VI is not executed when **status** is TRUE.



code is the error code number identifying an error. A value of 0 means success. A negative value means error: VI did not execute the intended operation. A positive value means warning: VI executed intended operation, but an informational warning is returned. For a description of the **code**, wire the error cluster to a LabVIEW error-handling VI, such as the **Simple Error Handler**.



source identifies the VI where the error occurred.

Output



ECU ref out is the same as **ECU ref in**. Wire the task reference to subsequent VIs for this task.



Error out describes error conditions. If the **Error in** cluster indicated an error, the **Error out** cluster contains the same information. Otherwise, **Error out** describes the error status of this VI.



status is `TRUE` if an error occurred.



code is the error code number identifying an error. A value of 0 means success. A negative value means error: VI did not execute the intended operation. A positive value means warning: VI executed intended operation, but an informational warning is returned. For a description of the **code**, wire the error cluster to a LabVIEW error-handling VI, such as the **Simple Error Handler**.



source identifies the VI where the error occurred.

Description

MC XCP Program Prepare.vi may be used to indicate a data download as a pre-condition for non-volatile memory reprogramming. The Memory Transfer address (MTA) pointer is set to the volatile memory location specified by the parameters **Address** and **Extension**. The download itself is done by using subsequent standard commands like **MC Download.vi**. The slave device must ensure that the target memory area is available and it is in an operational state which permits the download of code. If not, an error will be returned.

MC XCP Program Prepare.vi implements the optional XCP PROGRAM_PREPARE command defined by the XCP specification. For further information on how to program non-volatile ECU memory refer to the *ASAM XCP Part 2 Protocol Layer Specification*.

MC XCP Program Verify.vi

Purpose

Performs a non-volatile memory certification task on the ECU device.

Format

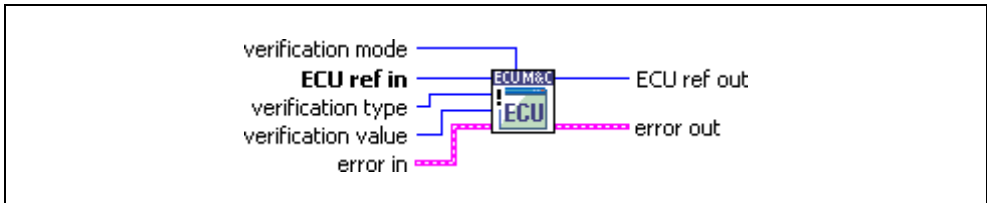

Input



Verification mode specifies the type of the requested identification:

Type	Description
0	Request to start internal routine.
1	Send a Verification Value stored in Verification value .



ECU ref in is the task reference which links to the selected ECU. This reference is originally returned from [MC ECU Open.vi](#) or [MC ECU Select.vi](#), and then wired through subsequent VIs.



Verification type specifies the Verification Type of the requested program verification. The Verification Type is a bit mask described below:

Verification Type	Description
0x0001	Calibration area(s) of the flash.
0x0002	Code area(s) of the flash.
0x0004	Complete flash content.
0x0008 ... 0x0080	Reserved.
0x0100 ... 0xFF00	User defined.



Verification value contains the selected verification value if Mode=1.

Error in is a cluster which describes error conditions occurring before the VI executes. If an error has already occurred, the VI returns the value of the **error in** cluster to **error out**.



status is TRUE if an error occurred. This VI will not execute when **status** is TRUE.



code is the error code number identifying an error. A value of 0 means success. A negative value means error: VI did not execute the intended operation. A positive value means warning: VI executed intended operation, but an informational warning is returned. For a description of the **code**, wire the error cluster to a LabVIEW error-handling VI, such as the **Simple Error Handler**.



source identifies the VI where the error occurred.

Output



ECU ref out is the same as **ECU ref in**. Wire the task reference to subsequent VIs for this task.



Error out describes error conditions. If the **Error in** cluster indicated an error, the **Error out** cluster contains the same information. Otherwise, **Error out** describes the error status of this VI.



status is TRUE if an error occurred.



code is the error code number identifying an error. A value of 0 means success. A negative value means error: VI did not execute the intended operation. A positive value means warning: VI executed intended operation, but an informational warning is returned. For a description of the **code**, wire the error cluster to a LabVIEW error-handling VI, such as the **Simple Error Handler**.



source identifies the VI where the error occurred.

Description

MC XCP Program Verify.vi may be used to verify the success of non-volatile memory reprogramming.

With **Verification mode** set to 00 the master may request the slave to begin internal test routines to check whether the new flash contents fits to the rest of the flash. Only the result is of interest. With **Verification mode** set to 01, the master may tell the slave that it will be sending a **Verification value** to the slave. The definition of the **Verification mode** is

project-specific. The master receives the **Verification mode** from the project-specific programming flow control and passes it to the slave.

MC XCP Program Verify.vi implements the optional XCP PROGRAM_VERIFY command defined by the XCP specification. For further information on how to program non-volatile ECU memory refer to the *ASAM XCP Part 2 Protocol Layer Specification*.

MC XCP Set Cal Page.vi

Purpose

Sets a calibration page.

Format

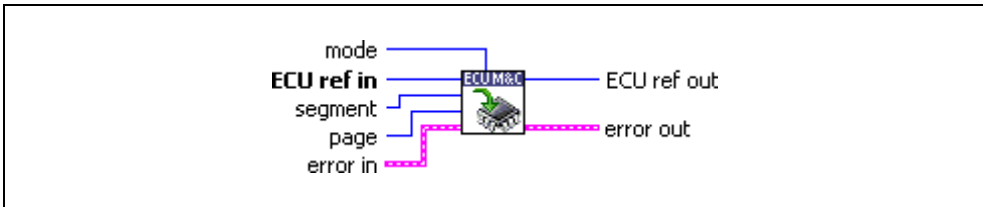

Input



Mode is a bit mask described below:

Bit	Description
0	The given page is used by the slave device application.
1	The slave device XCP driver will access the given page.
2	Unused.
3	Unused.
4	Unused.
5	Unused.
6	Unused.
7	The logical segment number is ignored. The command applies to all segments.



ECU ref in is the task reference which links to the selected ECU. This reference is originally returned from [MC ECU Open.vi](#) or [MC ECU Select.vi](#), and then wired through subsequent VIs.



Segment specifies the selected logical data segment number.



Page specifies the logical data page number.



Error in is a cluster which describes error conditions occurring before the VI executes. If an error has already occurred, the VI returns the value of the **error in** cluster to **error out**.



status is TRUE if an error occurred. This VI will not execute when **status** is TRUE.



code is the error code number identifying an error. A value of 0 means success. A negative value means error: VI did not execute the intended operation. A positive value means warning: VI executed intended operation, but an informational warning is returned. For a description of the **code**, wire the error cluster to a LabVIEW error-handling VI, such as the **Simple Error Handler**.



source identifies the VI where the error occurred.

Output



ECU ref out is the same as **ECU ref in**. Wire the task reference to subsequent VIs for this task.



Error out describes error conditions. If the **Error in** cluster indicated an error, the **Error out** cluster contains the same information. Otherwise, **Error out** describes the error status of this VI.



status is TRUE if an error occurred.



code is the error code number identifying an error. A value of 0 means success. A negative value means error: VI did not execute the intended operation. A positive value means warning: VI executed intended operation, but an informational warning is returned. For a description of the **code**, wire the error cluster to a LabVIEW error-handling VI, such as the **Simple Error Handler**.



source identifies the VI where the error occurred.

Description

MC XCP Set Cal Page.vi implements the XCP command SET_CAL_PAGE and sets the access mode for a calibration data segment, if the slave device supports calibration data page switching. A calibration data segment and its pages are specified by logical numbers.

Refer to the *ASAM XCP Part 2 Protocol Layer Specification* for more information on how to set up a request.

MC XCP Set Request.vi

Purpose

Performs a request to save session and device information to non-volatile memory.

Format

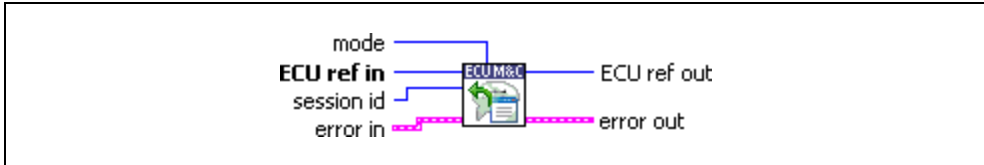

Input



Mode is a bit mask described below:

Bit	Description
0	Request to store calibration data in non-volatile memory.
1	Unused.
2	Request to save all DAQ lists, which have been selected with START_STOP_DAQ_LIST(Select) into non-volatile memory. The slave also must store the session configuration ID in non-volatile memory. Upon saving, the slave first must clear any DAQ list configuration that might already be stored in non-volatile memory.
3	Request to clear all DAQ lists in non-volatile memory. All ODT entries reset to address = 0, extension = 0, size = 0 and bit_offset = FF. Session configuration ID reset to 0.
4	Unused.
5	Unused.
6	Unused.
7	Unused.



ECU ref in is the task reference which links to the selected ECU. This reference is originally returned from **MC ECU Open.vi** or **MC ECU Select.vi**, and then wired through subsequent VIs.



Session ID is a session configuration ID that is stored in non-volatile memory together with the information requested by the **Mode** parameter.



Error in is a cluster which describes error conditions occurring before the VI executes. If an error has already occurred, the VI returns the value of the **error in** cluster to **error out**.



status is TRUE if an error occurred. This VI will not execute when **status** is TRUE.



code is the error code number identifying an error. A value of 0 means success. A negative value means error: VI did not execute the intended operation. A positive value means warning: VI executed intended operation, but an informational warning is returned. For a description of the **code**, wire the error cluster to a LabVIEW error-handling VI, such as the **Simple Error Handler**.



source identifies the VI where the error occurred.

Output



ECU ref out is the same as **ECU ref in**. Wire the task reference to subsequent VIs for this task.



Error out describes error conditions. If the **Error in** cluster indicated an error, the **Error out** cluster contains the same information. Otherwise, **Error out** describes the error status of this VI.



status is TRUE if an error occurred.



code is the error code number identifying an error. A value of 0 means success. A negative value means error: VI did not execute the intended operation. A positive value means warning: VI executed intended operation, but an informational warning is returned. For a description of the **code**, wire the error cluster to a LabVIEW error-handling VI, such as the **Simple Error Handler**.



source identifies the VI where the error occurred.

Description

MC XCP Set Request.vi implements the XCP command SET_REQUEST and is used to save session configuration information into non-volatile memory in the ECU.

Refer to the *ASAM XCP Part 2 Protocol Layer Specification* for more information on how to set up a request.

MC XCP Set Segment Mode.vi

Purpose

Sets the mode of a specified segment.

Format

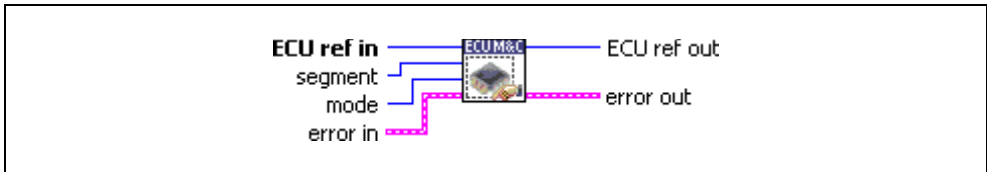

Input



ECU ref in is the task reference which links to the selected ECU. This reference is originally returned from [MC ECU Open.vi](#) or [MC ECU Select.vi](#), and then wired through subsequent VIs.



Segment specifies the logical data segment number.



Mode specifies the mode for the segment.



Error in is a cluster which describes error conditions occurring before the VI executes. If an error has already occurred, the VI returns the value of the **error in** cluster to **error out**.



status is TRUE if an error occurred. This VI will not execute when **status** is TRUE.



code is the error code number identifying an error. A value of 0 means success. A negative value means error: VI did not execute the intended operation. A positive value means warning: VI executed intended operation, but an informational warning is returned. For a description of the **code**, wire the error cluster to a LabVIEW error-handling VI, such as the [Simple Error Handler](#).



source identifies the VI where the error occurred.

Output



ECU ref out is the same as **ECU ref in**. Wire the task reference to subsequent VIs for this task.



Error out describes error conditions. If the **Error in** cluster indicated an error, the **Error out** cluster contains the same information. Otherwise, **Error out** describes the error status of this VI.



status is `TRUE` if an error occurred.



code is the error code number identifying an error. A value of 0 means success. A negative value means error: VI did not execute the intended operation. A positive value means warning: VI executed intended operation, but an informational warning is returned. For a description of the **code**, wire the error cluster to a LabVIEW error-handling VI, such as the **Simple Error Handler**.



source identifies the VI where the error occurred.

Description

MC XCP Set Segment Mode.vi implements the XCP command `SET_SEGMENT_MODE` and sets the selected segment into the specified mode. If **Mode** = 0 the segment disables the `FREEZE` mode, if **Mode** = 1 the segment is set to `FREEZE` mode through an XCP `STORE_CAL_REQ` operation.

Refer to the *ASAM XCP Part 2 Protocol Layer Specification* for more information on how to set up a request.

ECU M&C API for C

This chapter lists the ECU M&C functions and describes the format, purpose, and parameters. Unless otherwise stated, each ECU M&C function suspends execution of the calling thread until it completes. The functions in this chapter are listed alphabetically.

Section Headings

The following are section headings found in the ECU M&C API for C functions.

Purpose

Each function description includes a brief statement of the purpose of the function.

Format

The format section describes the format of each function for the C programming language.

Input and Output

The input and output parameters for each function are listed.

Description

The description section gives details about the purpose and effect of each function.

List of Data Types

The following data types are used with functions of the ECU M&C API for C.

Table 6-1. Data Types for the ECU M&C API for C

Data Type	Purpose
i8	8-bit signed integer
i16	16-bit signed integer
i32	32-bit signed integer

Table 6-1. Data Types for the ECU M&C API for C (Continued)

Data Type	Purpose
u8	8-bit unsigned integer
u16	16-bit unsigned integer
u32	32-bit unsigned integer
f32	32-bit floating-point number
f64	64-bit floating-point number
str	ASCII string represented as an array of characters terminated by null character ('\0'). This type is used with output strings. str is typically used in the ECU M&C API as a pointer to a string, as <code>char*</code> .
cstr	ASCII string represented as an array of characters terminated by null character ('\0'). This type is used with input strings. cstr is typically used in the ECU M&C API as a pointer to a string, as <code>const char*</code> .
mcTypeTaskRef	Reference to an initialized database task, ECU task, or Measurement task.
mcAddress	C struct which represents the target address for a specific CCP operation in the ECU.

List of Functions

The following table contains an alphabetical list of the ECU M&C Toolkit API functions.

Table 6-2. Functions for the ECU M&C API for C

Function	Purpose
<code>mcBuildChecksum</code>	Calculates a checksum over a defined memory range within the ECU.
<code>mcCalculateChecksum</code>	Calculates the checksum of a data block in memory.
<code>mcCCPActionService</code>	Calls an implementation-specific action service on the ECU.
<code>mcCCPDiagService</code>	Calls an implementation-specific diagnostic service on the ECU.
<code>mcCCPGetActiveCalPage</code>	Retrieves the ECU Memory Transfer Address pointer to the calibration data page.
<code>mcCCPGetResult</code>	Uploads data from the ECU when the Memory Transfer Address pointer 0 (MTA0) has been set.

Table 6-2. Functions for the ECU M&C API for C (Continued)

Function	Purpose
<code>mcCCPGetSessionStatus</code>	Retrieves the current status of the Calibration Session.
<code>mcCCPGetVersion</code>	Retrieves CCP version implemented in the ECU.
<code>mcCCPMoveMemory</code>	Moves a memory block on the ECU.
<code>mcCCPSelectCalPage</code>	Sets the specified address to be the start address of the calibration data page.
<code>mcCCPSetSessionStatus</code>	Updates the ECU with the current state of the calibration session.
<code>mcCharacteristicRead</code>	Reads all data from a named Characteristic on the ECU which is identified by the ECU Reference handle.
<code>mcCharacteristicReadSingleValue</code>	Reads a single value from a named Characteristic on the ECU which is identified by the ECU Reference handle.
<code>mcCharacteristicWrite</code>	Downloads data to a Characteristic for a selected ECU.
<code>mcCharacteristicWriteSingleValue</code>	Writes a single value to a named Characteristic on the ECU.
<code>mcClearMemory</code>	Clears the contents of the specified ECU memory.
<code>mcConversionCreate</code>	Creates a signal conversion object in memory.
<code>mcDAQClear</code>	Stops communication for the Measurement task and clears the task.
<code>mcDAQInitialize</code>	Initializes a Measurement task for the specified Measurement channel list.
<code>mcDAQListInitialize</code>	Defines a DAQ list on a specific DAQ list number and initializes the Measurement task for the specified Measurement channel list. Initializes a Measurement task for the specified Measurement channel list.
<code>mcDAQRead</code>	Reads samples from a Measurement task. Samples are obtained from received CAN messages.
<code>mcDAQReadTimestamped</code>	Reads timestamped samples from a DAQ task initialized with the selected mode of <code>mcDAQModeDAQListTimeStamped</code> .
<code>mcDAQStartStop</code>	Starts or stops the transmission of the DAQ lists for the specified Measurement task.
<code>mcDAQWrite</code>	Writes samples to an ECU DAQ list.

Table 6-2. Functions for the ECU M&C API for C (Continued)

Function	Purpose
<code>mcDatabaseClose</code>	Stops transmission of the DAQ lists for the specified Measurement task.
<code>mcDatabaseClose</code>	Closes a specified A2L Database reference.
<code>mcDatabaseOpen</code>	Opens a specified A2L Database.
<code>mcDownload</code>	Downloads data to an ECU.
<code>mcECUConnect</code>	Establishes communication to the selected ECU through CCP. After a successful ECU Connect you can create a Measurement Task or read/write a Characteristic.
<code>mcECUCreate</code>	Creates an ECU object in memory.
<code>mcECUDeselect</code>	Deselects an ECU and invalidates the ECU reference handle.
<code>mcECUDisconnect</code>	Disconnects CCP communication to the selected ECU.
<code>mcECUSelectEx</code>	Selects an ECU from the names stored in an A2L database.
<code>mcEventCreate</code>	Creates an Event object in memory.
<code>mcGeneric</code>	Sends a generic CCP command.
<code>mcGetNames</code>	Retrieves a comma-separated list of ECU, Measurement, Characteristic, or Event names from a specified A2L database.
<code>mcGetNamesLength</code>	Retrieves the amount of memory required to store the names returned by <code>mcGetNames</code> .
<code>mcGetProperty</code>	Retrieves a property of the driver, the database, the ECU, a Characteristic, a Measurement, or a Measurement task.
<code>mcMeasurementCreate</code>	Creates a Measurement object in memory.
<code>mcMeasurementRead</code>	Reads a single Measurement value from the ECU.
<code>mcMeasurementWrite</code>	Writes a single Measurement value to the ECU.
<code>mcProgram</code>	Programs a memory block on the ECU.
<code>mcProgramReset</code>	Indicates the end of a programming sequence.
<code>mcProgramStart</code>	Indicates the start of a programming sequence.
<code>mcSetProperty</code>	Sets a property of the driver, the database, the ECU, a Characteristic, a Measurement, or a Measurement task.

Table 6-2. Functions for the ECU M&C API for C (Continued)

Function	Purpose
<code>mcStatusToString</code>	Converts a status code into a descriptive string.
<code>mcUpload</code>	Uploads data from an ECU.
<code>mcXCPCopyCalPage</code>	Forces a copy transaction of one calibration page to another.
<code>mcXCPCGetCalPage</code>	Queries a calibration page setting.
<code>mcXCPCGetID</code>	Queries session configuration or slave device identification.
<code>mcXCPCGetStatus</code>	Queries the current session status from an ECU slave device.
<code>mcXCPCProgramPrepare</code>	Prepares the programming of non volatile memory.
<code>mcXCPCProgramVerify</code>	Performs a non-volatile memory certification task on the ECU device.
<code>mcXCPCSetCalPage</code>	Sets a calibration page.
<code>mcXCPCSetRequest</code>	Performs a request to save session and device information to non-volatile memory.
<code>mcXCPCSetSegmentMode</code>	Sets the mode of a specified segment.

mcBuildChecksum

Purpose

Calculates a checksum over a defined memory range within the ECU.

Format

```
mcTypeStatus      mcBuildChecksum(
                    mcTypeTaskRef ECURefNum,
                    mcAddress Address,
                    u32 BlockSize,
                    u8 *ChecksumType,
                    u8 *SizeOfChecksum
                    u32 *Checksum);
```

Input

ECURefNum	ECURefNum is the task reference which links to the selected ECU. This reference is originally returned from mcECUSelectEx .
Address	Configures the target address for the checksum operation in the ECU. mcAddress is a C struct consisting of: <p>Address Specifies the address part of the target address.</p> <p>Extension Extension contains the extension part of the target address.</p>
BlockSize	BlockSize determines the size of the block on which the checksum must be calculated.
ChecksumType	ChecksumType returns the type of the calculated checksum. For CCP, ChecksumType is 0xFF. For XCP, refer to the Description section.

Output

SizeofChecksum	SizeofChecksum returns the size in bytes of the calculated checksum.
Checksum	Checksum is the calculated checksum.

Return Value

The return value indicates the status of the function call as a signed 32-bit integer. Zero means the function executed successfully. A negative value specifies an error, which means the function did not perform the expected behavior. A positive value specifies a warning, which means the function performed as expected, but a condition arose that may require attention.

Use the `mcStatusToString` function of the ECU M&C API to obtain a descriptive string for the return value.

Description

`mcBuildChecksum` is used to calculate the checksum of a specified memory block inside the ECU starting at the selected `Address`.

If you are using the CCP protocol, `mcBuildChecksum` implements the CCP `BUILD_CHKSUM` command. The checksum algorithm is not specified by CCP and the checksum algorithm may be different on different devices.

If you are using the XCP protocol, `mcBuildChecksum` implements the `BUILD_CHECKSUM` command of the XCP specification. The result of the checksum calculation is returned in `Checksum` regardless of the checksum type. The following values for `ChecksumType` are defined in the XCP specification:

Type	Name	Description
0x01	XCP_ADD_11	Add BYTE into a BYTE checksum, ignore overflows
0x02	XCP_ADD_12	Add BYTE into a WORD checksum, ignore overflows
0x03	XCP_ADD_14	Add BYTE into a DWORD checksum, ignore overflows
0x04	XCP_ADD_22	Add WORD into a WORD checksum, ignore overflows, <code>blocksize</code> must be modulo 2
0x05	XCP_ADD_24	Add WORD into a DWORD checksum, ignore overflows, <code>blocksize</code> must be modulo 2
0x06	XCP_ADD_44	Add DWORD into DWORD, ignore overflows, <code>blocksize</code> must be modulo 4
0x07	XCP_CRC_16	Refer to CRC error detection algorithms
0x08	XCP_CRC_16_CITT	Refer to CRC error detection algorithms
0x09	XCP_CRC_32	Refer to CRC error detection algorithms
0xFF	XCP_USER_DEFINED	User defined algorithm, in externally calculated function

With `ChecksumType XCP_USER_DEFINED`, the Slave may indicate that the Master which calculates the checksum must use a user-defined algorithm implemented in an externally calculated function (for instance, Win32 DLL, UNIX shared object file, etc.). The master retrieves the name of the external function file to be used for this slave from the ASAM MCD 2MC description file.

The CRC algorithms are specified by the following parameters:

Name	Width	Poly	Init	Refin	Refout	XORout
XCP_CRC_16	16	0x8005	0x0000	TRUE	TRUE	0x0000
XCP_CRC16_CITT	16	0x1021	0xFFFF	FALSE	FALSE	0x0000
XCP_CRC_32_32	32	0x04C11DB7	0xFFFFFFFF	TRUE	TRUE	0xFFFFFFFF

Name

The name of the algorithm. A string value starting with “XCP_”.

Width

The width of the algorithm expressed in bits. This is one less than the width of the Poly.

Poly

The polynomial. This is a binary value specified as a hexadecimal number. The top bit of the Poly should be omitted. For example, if the Poly is 0x10110, you should specify 0x06. An important aspect of this parameter is that it represents the unreflected polynomial. The bottom of this parameter is always the least significant bit (LSB) of the divisor during the division, regardless of whether the algorithm is reflected.

Init

This parameter specifies the initial value of the register when the algorithm starts. This is the value to be assigned to the register in the direct table algorithm. In the table algorithm, we may think of the register always commencing with the value zero, and this value being XORed into the register after the *n*th bit iteration. This parameter should be specified as a hexadecimal number.

Refin

A Boolean parameter. If it is FALSE, input bytes are processed with bit 7 being treated as the most significant bit (MSB) and bit 0 being treated as the least significant bit. If this parameter is TRUE, each byte is reflected before being processed.

Refout

A Boolean parameter. If it is set to FALSE, the final value in the register is fed into the XORout stage directly. If this parameter is TRUE, the final register value is reflected first.

XORout

This is a width-bit value that should be specified as hexadecimal number. It is XORed to the final register value (after the Refout stage) before the value is returned as the official checksum.

For more detailed information about CRC algorithms, refer to:

http://www.repairfaq.org/filipg/LINK/F_crc_v34.html

mcCalculateChecksum

Purpose

Calculates the checksum of a data block in memory.

Format

```
mcTypeStatus      mcCalculateChecksum(
                    mcTypeTaskRef ECURefNum,
                    u32 BlockSize,
                    u8 *Data,
                    u8 TypeOfChecksum,
                    u8 *SizeOfChecksum,
                    u32 *Checksum);
```

Input

ECURefNum	ECURefNum is the task reference which links to the selected ECU. This reference is originally returned from mcECUSelectEx .
BlockSize	BlockSize determines the size of the block on which the checksum must be calculated.
TypeOfChecksum	TypeOfChecksum specifies the type of the calculated checksum.

Output

Data	Data is a byte array upon which the checksum calculation is performed.
SizeofChecksum	SizeofChecksum returns the size in bytes of the calculated checksum.
Checksum	Checksum is the calculated checksum.

Return Value

The return value indicates the status of the function call as a signed 32-bit integer. Zero means the function executed successfully. A negative value specifies an error, which means the function did not perform the expected behavior. A positive value specifies a warning, which means the function performed as expected, but a condition arose that may require attention.

Use the [mcStatusToString](#) function of the ECU M&C API to obtain a descriptive string for the return value.

Description

`mcCalculateChecksum` implements a checksum calculation over a given data block. The checksum algorithm is performed over a dedicated checksum function provided by a specific DLL. The name of the Checksum DLL is defined in the A2L data base and can be changed by the application by the `mcSetProperty` function using the `mcPropECU_Checksum` property.

If you are using the CCP protocol, `TypeOfChecksum` must be set to `0xFFh`, since CCP only supports an external checksum DLL. If you are using XCP, the following values for `TypeOfChecksum` are defined in the XCP specification:

Type	Name	Description
0x01	XCP_ADD_11	Add BYTE into a BYTE checksum, ignore overflows
0x02	XCP_ADD_12	Add BYTE into a WORD checksum, ignore overflows
0x03	XCP_ADD_14	Add BYTE into a DWORD checksum, ignore overflows
0x04	XCP_ADD_22	Add WORD into a WORD checksum, ignore overflows, <code>blocksize</code> must be modulo 2
0x05	XCP_ADD_24	Add WORD into a DWORD checksum, ignore overflows, <code>blocksize</code> must be modulo 2
0x06	XCP_ADD_44	Add DWORD into DWORD, ignore overflows, <code>blocksize</code> must be modulo 4
0x07	XCP_CRC_16	Refer to CRC error detection algorithms
0x08	XCP_CRC_16_CITT	Refer to CRC error detection algorithms
0x09	XCP_CRC_32	Refer to CRC error detection algorithms
0xFF	XCP_USER_DEFINED	User defined algorithm, in externally calculated function

For a detailed description of the checksum algorithm refer to the `mcBuildChecksum` command or the *XCP Part 2 Protocol Layer Specification*.

For more detailed information about CRC algorithms, please refer to:

http://www.repairfaq.org/filipg/LINK/F_crc_v34.html

mcCCPActionService

Purpose

Calls an implementation-specific action service on the ECU (CCP only).

Format

```
mcTypeStatus      mcCCPActionService (
                    mcTypeTaskRef ECURefNum,
                    u16 ServiceNo,
                    u8 Params[4],
                    u8 *ResultLength,
                    u8 *DataType);
```

Input

ECURefNum	ECURefNum is the task reference which links to the selected ECU. This reference is originally returned from mcECUSelectEx .
ServiceNo	ServiceNo determines the service that is executed inside the ECU. For more information about the services that are implemented in the ECU refer to the documentation for the ECU.
Params	Params passes the parameters of the service function as an array of bytes to the ECU. Since the parameters and their data types are specific to the ECU implementation, you are responsible of providing the required parameters in the correct byte ordering.

Output

*ResultLength	ResultLength indicates the amount of data that can be uploaded from the ECU as a result of the execution of the service. The result of this service can be accessed by calling the function mcCCPGetResult right after <code>mcCCPActionService</code> .
*DataType	DataType is a data type qualifier that determines the data format of the result.

Return Value

The return value indicates the status of the function call as a signed 32-bit integer. Zero means the function executed successfully. A negative value specifies an error, which means the function did not perform the expected behavior. A positive value specifies a warning, which means the function performed as expected, but a condition arose that may require attention.

Use the [mcStatusToString](#) function of the ECU M&C API to obtain a descriptive string for the return value.

Description

`mcCCPActionService` implements the CCP command ACTION_SERVICE. The ECU carries out the requested service and automatically sets the Memory Transfer Address MTA0 to the location from which the CCP master may upload the requested action service return information (if applicable).

The result of this service can be accessed by calling the function `mcCCPGetResult` right after `mcCCPActionService`.

mcCCPDiagService

Purpose

Calls an implementation-specific diagnostic service on the ECU (CCP only).

Format

```
mcTypeStatus      mcCCPDiagService (
                    mcTypeTaskRef ECURefNum,
                    u16 ServiceNo,
                    u8 Params[4],
                    u8 *ResultLength,
                    u8 *DataType);
```

Input

ECURefNum	ECURefNum is the task reference which links to the selected ECU. This reference is originally returned from mcECUSelectEx .
ServiceNo	ServiceNo determines the diagnostic service that is executed inside the ECU. For more information about the services that are implemented in the ECU refer to the documentation for the ECU.
Params	Params passes an array of bytes to the ECU that might be needed by the ECU to run the diagnostic service. Since the definition of the parameters is specific to the implementation of the ECU, the parameters can only be passed as an array of bytes. It is your responsibility to pass the correct number of parameters in the correct byte ordering to this function.

Output

*ResultLength	ResultLength returns the number of bytes that can be uploaded from the ECU as a result of the execution of the service. The result of this service can be accessed by calling the function mcCCPGetResult right after mcCCPDiagService.
*DataType	DataType is a data type qualifier which provides information about the data type of the result of the diagnostic service.

Return Value

The return value indicates the status of the function call as a signed 32-bit integer. Zero means the function executed successfully. A negative value specifies an error, which means the function did not perform the expected behavior. A positive value specifies a warning, which means the function performed as expected, but a condition arose that may require attention.

Use the `mcStatusToString` function of the ECU M&C API to obtain a descriptive string for the return value.

Description

`mcCCPDiagService` implements the CCP command `DIAG_SERVICE` which calls a diagnostic service on the ECU and waits until it is finished. The selected `ServiceNo` specifies the diagnostic service that must be executed inside the ECU. For more information about the available services that are implemented in the ECU refer to the documentation for the ECU.

The result of this service can be accessed by calling the function `mcCCPGetResult` right after `mcCCPDiagService`.

mcCCPGetActiveCalPage

Purpose

Retrieves the ECU Memory Transfer Address pointer to the calibration data page (CCP only).

Format

```
mcTypeStatus      mcCCPGetActiveCalPage (
                    mcTypeTaskRef ECURefNum,
                    mcAddress *Address);
```

Input

ECURefNum ECURefNum is the task reference which links to the selected ECU. This reference is originally returned from [mcECUSelectEx](#).

Output

Address Returns the address for the active calibration page in the ECU. mcAddress is a C struct consisting of:

Address

Specifies the address part of the address.

Extension

Extension contains the extension part of the address.

Return Value

The return value indicates the status of the function call as a signed 32-bit integer. Zero means the function executed successfully. A negative value specifies an error, which means the function did not perform the expected behavior. A positive value specifies a warning, which means the function performed as expected, but a condition arose that may require attention.

Use the [mcStatusToString](#) function of the ECU M&C API to obtain a descriptive string for the return value.

Description

mcCCPGetActiveCalPage retrieves the start address of the active calibration data page in the ECU memory.

mcCCPGetResult

Purpose

Uploads data from the ECU when the Memory Transfer Address pointer 0 (MTA0) has been set (CCP only).

Format

```
mcTypeStatus      mcCCPGetResult (
                    mcTypeTaskRef ECURefNum,
                    u32 BlockSize,
                    u8 *Data);
```

Input

ECURefNum	ECURefNum is the task reference which links to the selected ECU. This reference is originally returned from mcECUSelectEx .
BlockSize	BlockSize determines the size of the data block to be uploaded from the ECU.

Output

Data	Data contains the data uploaded from the ECU memory.
------	--

Return Value

The return value indicates the status of the function call as a signed 32-bit integer. Zero means the function executed successfully. A negative value specifies an error, which means the function did not perform the expected behavior. A positive value specifies a warning, which means the function performed as expected, but a condition arose that may require attention.

Use the [mcStatusToString](#) function of the ECU M&C API to obtain a descriptive string for the return value.

Description

This function uploads data from the ECU. It is assumed that the Memory Transfer Address 0 (MTA0) has already been set to the start address of the data to be uploaded. Functions like [mcCCPActionService](#) or [mcCCPDiagService](#) implicitly set the Memory Transfer Address 0 (MTA0) to the beginning of their result. To upload data from a specified address, use [mcUpload](#) instead.

mcCCPGetSessionStatus

Purpose

Retrieves the current status of the Calibration Session (CCP only).

Format

```
mcTypeStatus      mcCCPGetSessionStatus (
                    mcTypeTaskRef ECURefNum,
                    u8 *SessionStatus,
                    u8 *StatusQualifier,
                    u8 *AdditionalStatus);
```

Input

ECURefNum ECURefNum is the task reference which links to the selected ECU. This reference is originally returned from [mcECUSelectEx](#).

Output

SessionStatus The current SessionStatus which is returned from the ECU.
 StatusQualifier The additional StatusQualifier is manufacturer and/or project specific and is not part of the CCP protocol specification.
 AdditionalStatus If the StatusQualifier does not contain additional status information, AdditionalStatus must be set to FALSE. If AdditionalStatus is not FALSE, it may be used to determine the type of the additional status information

Return Value

The return value indicates the status of the function call as a signed 32-bit integer. Zero means the function executed successfully. A negative value specifies an error, which means the function did not perform the expected behavior. A positive value specifies a warning, which means the function performed as expected, but a condition arose that may require attention.

Use the [mcStatusToString](#) function of the ECU M&C API to obtain a descriptive string for the return value.

Description

`mcCCPGetSessionStatus` retrieves the current calibration session status of the ECU. The return value `SessionStatus` is a bit mask that represents several session states inside the ECU. `StatusQualifier` and `AdditionalStatus` contain additional status information. The content of these parameters is ECU specific and not defined by CCP. For more information about the parameter `SessionStatus`, refer to the description of `mcCCPSetSessionStatus`.

mcCCPGetVersion

Purpose

Retrieves CCP version implemented in the ECU (CCP only).

Format

```
mcTypeStatus      mcCCPGetVersion(
                    mcTypeTaskRef ECURefNum,
                    u8 *MajorVersion,
                    u8 *MinorVersion);
```

Input

ECURefNum ECURefNum is the task reference which links to the selected ECU. This reference is originally returned from [mcECUSelectEx](#).

Output

MajorVersion MajorVersion returns the major version number of the CCP implementation.

MinorVersion MinorVersion returns the minor version number of the CCP implementation.

Return Value

The return value indicates the status of the function call as a signed 32-bit integer. Zero means the function executed successfully. A negative value specifies an error, which means the function did not perform the expected behavior. A positive value specifies a warning, which means the function performed as expected, but a condition arose that may require attention.

Use the [mcStatusToString](#) function of the ECU M&C API to obtain a descriptive string for the return value.

Description

`mcCCPGetVersion` can be used to query the CCP version implemented in the ECU. This command performs a mutual identification of the protocol version in the slave device to agree on a common protocol version.

`mcCCPGetVersion` implements the CCP command GET_CCP_VERSION defined by the CCP specification.

mcCCPMoveMemory

Purpose

Moves a memory block on the ECU (CCP only).

Format

```
mcTypeStatus      mcCCPMoveMemory (
                    mcTypeTaskRef ECURefNum,
                    mcAddress Source,
                    mcAddress Destination,
                    u32 BlockSize);
```

Input

ECURefNum	ECURefNum is the task reference which links to the selected ECU. This reference is originally returned from mcECUSelectEx .
Source	Configures the source address for the memory move operation in the ECU. mcAddress is a C struct consisting of: <p>Address Specifies the address part of the source address.</p> <p>Extension Extension contains the extension part of the source address.</p>
Destination	Configures the destination address for the memory move operation in the ECU. mcAddress is a C struct consisting of: <p>Address Specifies the address part of the destination address.</p> <p>Extension Extension contains the extension part of the destination address.</p>
BlockSize	BlockSize determines the size of memory block in bytes which should be moved from the source address to the destination address.

Output

Return Value

The return value indicates the status of the function call as a signed 32-bit integer. Zero means the function executed successfully. A negative value specifies an error, which means the function did not perform the expected behavior. A positive value specifies a warning, which means the function performed as expected, but a condition arose that may require attention.

Use the `mcStatusToString` function of the ECU M&C API to obtain a descriptive string for the return value.

Description

`mcCCPMoveMemory` is used to move the memory contents of an ECU from one memory location to another. Before calling the CCP MOVE command this function sets the Memory Transfer Address pointers MTA0 as defined in the source struct and MTA1 as defined in the destination struct to appropriate values.

`mcCCPMoveMemory` implements the CCP command MOVE defined by the CCP specification.

mcCCPSelectCalPage

Purpose

Sets the specified address to be the start address of the calibration data page (CCP only).

Format

```
mcTypeStatus          mcCCPSelectCalPage (
                        mcTypeTaskRef ECURefNum,
                        mcAddress Address);
```

Input

ECURefNum	ECURefNum is the task reference which links to the selected ECU. This reference is originally returned from mcECUSelectEx .
Address	Configures the target address for the programming operation in the ECU. mcAddress is a C struct consisting of:

Address

Specifies the address part of the target address.

Extension

Extension contains the extension part of the address.

Output

Return Value

The return value indicates the status of the function call as a signed 32-bit integer. Zero means the function executed successfully. A negative value specifies an error, which means the function did not perform the expected behavior. A positive value specifies a warning, which means the function performed as expected, but a condition arose that may require attention.

Use the [mcStatusToString](#) function of the ECU M&C API to obtain a descriptive string for the return value.

Description

mcCCPSelectCalPage implements the CCP command SELECT_CAL_PAGE. This command sets the beginning of the calibration data page to the specified address within the ECU.

mcCCPSetSessionStatus

Purpose

Updates the ECU with the current state of the calibration session (CCP only).

Format

```
mcTypeStatus      mcCCPSetSessionStatus (
                    mcTypeTaskRef  ECURefNum,
                    u8  SessionStatus);
```

Input

ECURefNum ECURefNum is the task reference which links to the selected ECU. This reference is originally returned from [mcECUSelectEx](#).

SessionStatus SessionStatus contains the new status to be set in the ECU.

Output

Return Value

The return value indicates the status of the function call as a signed 32-bit integer. Zero means the function executed successfully. A negative value specifies an error, which means the function did not perform the expected behavior. A positive value specifies a warning, which means the function performed as expected, but a condition arose that may require attention.

Use the [mcStatusToString](#) function of the ECU M&C API to obtain a descriptive string for the return value.

Description

`mcCCPSetSessionStatus` implements the CCP command SET_S_STATUS and is used to keep the ECU informed about the current state of the calibration session. The session status bits of an ECU can be read and written. Possible conditions are: reset on power-up, session log-off, and in applicable error conditions. The calibration session status is organized as a bit mask with the following assignment.

Table 6-3. Bit Mask Assignments for Calibration Session Status

Bit	Name	Description
0	CAL	Calibration data initialized.
1	DAQ	DAQ list(s) initialized.
2	RESUME	Request to save DAQ set-up during shutdown in CCP slave. CCP slave automatically restarts DAQ after start-up.

Table 6-3. Bit Mask Assignments for Calibration Session Status (Continued)

Bit	Name	Description
3	Reserved	—
4	Reserved	—
5	Reserved	—
6	STORE	Request to save calibration data during shut-down in CCP slave.
7	RUN	Session in progress.

mcCharacteristicRead

Purpose

Reads all data from a named Characteristic on the ECU which is identified by the ECU Reference handle.

Format

```
mcTypeStatus      mcCharacteristicRead(
                    mcTypeTaskRef ECURefNum,
                    char *CharacteristicName,
                    f64 *Values,
                    u32 NumberOfValues);
```

Input

ECURefNum	ECURefNum is the task reference which links to the selected ECU. This reference is originally returned from mcECUSelectEx .
CharacteristicName	CharacteristicName is the name of the Characteristic defined in the A2L database file.
NumberOfValues	Specifies the number of values to read. To determine the dimension of the Characteristic use the mcGetProperty function upfront using the parameter <code>mcPropChar_Dimension</code> . To determine the size of each dimension use the mcGetProperty function with the parameter <code>mcPropChar_Sizes</code> .

Output

Values	Returns a single value, a 1-dimensional array, or a 2-dimensional array of values for the selected Characteristic.
--------	--

Return Value

The return value indicates the status of the function call as a signed 32-bit integer. Zero means the function executed successfully. A negative value specifies an error, which means the function did not perform the expected behavior. A positive value specifies a warning, which means the function performed as expected, but a condition arose that may require attention.

Use the [mcStatusToString](#) function of the ECU M&C API to obtain a descriptive string for the return value.

Description

`mcCharacteristicRead` reads values from a named Characteristic on the ECU which is identified by the ECU Reference handle. The function returns a double, 1D, or 2D array.

mcCharacteristicReadSingleValue

Purpose

Reads a single value from a named Characteristic on the ECU which is identified by the ECU Reference handle.

Format

```
mcTypeStatus      mcCharacteristicReadSingleValue (
                    mcTypeTaskRef ECURefNum,
                    char *CharacteristicName,
                    f64 Value,
                    u32 X,
                    u32 Y);
```

Input

ECURefNum	ECURefNum is the task reference which links to the selected ECU. This reference is originally returned from mcECUSelectEx .
CharacteristicName	CharacteristicName is the name of the Characteristic defined in the A2L database file.
X	X is the horizontal index if the Characteristic consists of 1 or 2 dimensions.
Y	Y is the vertical index if the Characteristic consists of 2 dimensions.

Output

Value	Returns a single value from the selected Characteristic.
-------	--

Return Value

The return value indicates the status of the function call as a signed 32-bit integer. Zero means the function executed successfully. A negative value specifies an error, which means the function did not perform the expected behavior. A positive value specifies a warning, which means the function performed as expected, but a condition arose that may require attention.

Use the [mcStatusToString](#) function of the ECU M&C API to obtain a descriptive string for the return value.

Description

`mcCharacteristicReadSingleValue` reads a value from a named Characteristic on the ECU which is identified by the ECU Reference handle. The value to be read is identified by the `x` and `y` indices.

If the Characteristic array is 0-dimensional, `x` and `y` can be set to 0.

If the Characteristic array is 1-dimensional, `y` can be set to 0.

mcCharacteristicWrite

Purpose

Downloads data to a Characteristic for a selected ECU.

Format

```
mcTypeStatus      mcCharacteristicWrite(
                    mcTypeTaskRef ECURefNum,
                    char *CharacteristicName,
                    f64 Values,
                    u32 NumberOfValues);
```

Input

ECURefNum	ECURefNum is the task reference which links to the selected ECU. This reference is originally returned from mcECUSelectEx .
CharacteristicName	CharacteristicName is the name of the Characteristic defined in the A2L database file.
Values	Values contains a pointer to a double, a double 1D, or 2D array which is sent to the ECU.
NumberOfValues	Specifies the number of values to write for the task.

Output

Return Value

The return value indicates the status of the function call as a signed 32-bit integer. Zero means the function executed successfully. A negative value specifies an error, which means the function did not perform the expected behavior. A positive value specifies a warning, which means the function performed as expected, but a condition arose that may require attention.

Use the [mcStatusToString](#) function of the ECU M&C API to obtain a descriptive string for the return value.

Description

`mcCharacteristicWrite` writes the value(s) of a named Characteristic to an ECU identified by the ECU reference handle `ECURefNum`.

mcCharacteristicWriteSingleValue

Purpose

Writes a single value to a named Characteristic on the ECU.

Format

```
mcTypeStatus      mcCharacteristicWriteSingleValue(
                    mcTypeTaskRef ECURefNum,
                    char *CharacteristicName,
                    f64 Value,
                    u32 X,
                    u32 Y);
```

Input

ECURefNum	ECURefNum is the task reference which links to the selected ECU. This reference is originally returned from mcECUSelectEx .
CharacteristicName	CharacteristicName is the name of the Characteristic defined in the A2L database file, to which the values are written.
Value	Value contains the value which is sent to the ECU.
X	X refers to the array offset of the Characteristic defined in the A2L database file as 1- or 2-dimensional. If the Characteristic is defined as 0-dimensional you can set X to 0.
Y	Y refers to the array offset of the Characteristic defined in the A2L database file as 2-dimensional. If the Characteristic is defined as 0- or 1-dimensional you can set Y to 0.

Output

Return Value

The return value indicates the status of the function call as a signed 32-bit integer. Zero means the function executed successfully. A negative value specifies an error, which means the function did not perform the expected behavior. A positive value specifies a warning, which means the function performed as expected, but a condition arose that may require attention.

Use the [mcStatusToString](#) function of the ECU M&C API to obtain a descriptive string for the return value.

Description

`mcCharacteristicWriteSingleValue` writes a value to a named Characteristic on the ECU which is identified by the ECU Reference handle `ECURefNum`. The location to which the value is written is identified by the `x` and `y` indices. If the Characteristic array is 0- or 1-dimensional, `y` and/or `x` can be set to 0.

mcClearMemory

Purpose

Clears the contents of the specified ECU memory.

Format

```
mcTypeStatus      mcClearMemory(
                    mcTypeTaskRef ECURefNum,
                    mcAddress Address,
                    u32 BlockSize);
```

Input

ECURefNum	ECURefNum is the task reference which links to the selected ECU. This reference is originally returned from mcECUSelectEx .
Address	Configures the target address to be cleared in the ECU. mcAddress is a C struct consisting of: <p>Address Specifies the address part of the target address.</p> <p>Extension Extension contains the extension part of the target address.</p>
BlockSize	BlockSize determines the size of the block on which the checksum must be calculated.

Output

Return Value

The return value indicates the status of the function call as a signed 32-bit integer. Zero means the function executed successfully. A negative value specifies an error, which means the function did not perform the expected behavior. A positive value specifies a warning, which means the function performed as expected, but a condition arose that may require attention.

Use the [mcStatusToString](#) function of the ECU M&C API to obtain a descriptive string for the return value.

Description

`mcClearMemory` can be used to clear the contents of the non-volatile memory prior to reprogramming it. The Memory Transfer Address 0 (MTA 0) is set to the start of the memory block automatically by this function. The `size` parameter is the size of the block to be erased. If you are using the XCP protocol, `mcClearMemory` implements the PROGRAM_CLEAR command. Refer to the ASAM XCP specification for further information on how to clear parts of non-volatile memory in the ECU.

mcConversionCreate

Purpose

Creates a signal conversion object in memory.

Format

```
mcTypeStatus      mcConversionCreate(
                    mcTypeTaskRef ECURefNum,
                    char *ConversionName,
                    f64 Factor,
                    f64 Offset,
                    char *Unit);
```

Input

ECURefNum	ECURefNum is the task reference that links to the selected ECU. This reference is originally returned from mcECUCreate .
ConversionName	ConversionName identifies the conversion object that handles measurement scaling. Use this name as a reference in mcConversionCreate .
Factor	Factor configures the scaling factor used to convert raw measurement data in the message to/from scaled floating-point units. The factor is the A in the linear scaling formula $AX+B$, where X is the raw data, and B is the scaling offset.
Offset	Offset configures the scaling offset used to convert raw data in the measurement message to/from scaled floating-point units. The scaling offset is the B in the linear scaling formula $AX+B$, where X is the raw data, and A is the scaling factor.
Unit	Configures the measurement channel unit string. You can use this value to display units (such as volts or RPM) along with the channel samples.

Output

Return Value

The return value indicates the status of the function call as a signed 32-bit integer. Zero means the function executed successfully. A negative value specifies an error, which means the function did not perform the expected behavior. A positive value specifies a warning, which means the function performed as expected, but a condition arose that may require attention.

Use the [mcStatusToString](#) function of the ECU M&C API to obtain a descriptive string for the return value.

Description

Use `mcConversionCreate` to create a conversion object in memory instead of referring to measurement properties defined in the A2L database.

mcDAQClear

Purpose

Stops communication for the Measurement task and clears the task.

Format

```
mcTypeStatus      mcDAQClear (  
                    mcTypeTaskRef *DAQRefNum) ;
```

Input

DAQRefNum DAQRefNum is the task reference which links to the selected Measurement task. This reference is originally returned from [mcDAQInitialize](#).

Output

Return Value

The return value indicates the status of the function call as a signed 32-bit integer. Zero means the function executed successfully. A negative value specifies an error, which means the function did not perform the expected behavior. A positive value specifies a warning, which means the function performed as expected, but a condition arose that may require attention.

Use the [mcStatusToString](#) function of the ECU M&C API to obtain a descriptive string for the return value.

Description

`mcDAQClear` must always be the final function called for a Measurement task. If you do not use `mcDAQClear`, the remaining Measurement task configuration can cause problems in the execution of subsequent applications. Because this function clears the Measurement task, the Measurement task reference is not given as an output but is transferred into an ECU reference task handle. To change properties of a running Measurement task, use [mcDAQStartStop](#) to stop the task, [mc SetProperty](#) to change the desired DAQ property, then [mcDAQStartStop](#) to restart the Measurement task.

mcDAQInitialize

Purpose

Initializes a Measurement task for the specified Measurement channel list.

Format

```
mcTypeStatus      mcDAQInitialize(
                    cstr MeasurementNames,
                    mcTypeTaskRef ECURefNum,
                    i32 DAQMode,
                    u32 DTO_ID,
                    f64 SampleRate,
                    mcTypeTaskRef *DAQRefNum);
```

Input

MeasurementNames	Comma-separated list of Measurement names to initialize as a task. You can type in the channel list as a string constant or you can obtain the list from an A2L database file by using the mcGetNames function.
ECURefNum	ECURefNum is the task reference which links to the selected ECU. This reference is originally returned from mcECUSelectEx .
DAQMode	DAQMode specifies the I/O mode for the task. For an overview of the I/O modes, including figures, refer to the Basic Programming Model section of Chapter 4, Using the ECU M&C API .

mcDAQModeDAQList

Data is transmitted automatically by the ECU using DAQ lists. The data can be read back with the [mcDAQRead](#) as Single point data using sample rate = 0 or as waveform using a sample rate > 0. Input channel data is received from the DAQ messages.

mcDAQModePolling

In this mode the data from the Measurement task are uploaded from the ECU whenever [mcDAQRead](#) is called.

mcDAQModeSTIMList

For XCP, this defines a DAQ list for data stimulation (STIM). Within a DAQ task initialized with this parameter, you can call [mcDAQWrite](#) to write stimulation data to the ECU. Calling [mcDAQRead](#) is not allowed. For CCP, an error is returned.

mcDAQModeDAQListTimeStamped

The data is transmitted from the ECU in equidistant time intervals as defined in the A2L database. The data can be read back with [mcDAQReadTimeStamped](#) as a timestamped data array. Input channel data are received from the DAQ messages. Use [mcDAQReadTimeStamped](#) to obtain input samples as an array of sample/timestamp pairs. Use this input mode to read samples with timestamps that indicate when each channel is received from the network.

DT0_ID

DT0_ID is the CAN identifier for the **Data Transmission Object (DTO)** used to transmit the data from the DAQ lists to the host. The default value is -1 which means that the DT0_ID used to transmit the DAQ list data is the same that is used for the rest of the CCP communication.

SampleRate

SampleRate specifies the timing to use for samples of the (NI-CAN) task. The sample rate is specified in Hertz (samples per second). A sample rate of zero means to sample immediately.

For a DAQMode of **mcDAQModeDAQList**, SampleRate of zero means that [mcDAQRead](#) returns a single sample from the most recent messages received, and greater than zero means that [mcDAQRead](#) returns samples timed at the specified rate. For DAQMode of **mcDAQModePolling**, SampleRate is ignored.

Output

DAQRefNum

DAQRefNum is the reference handle for the Measurement task. Use this Measurement task reference in subsequent M&C DAQ functions for this task.

Return Value

The return value indicates the status of the function call as a signed 32-bit integer. Zero means the function executed successfully. A negative value specifies an error, which means the function did not perform the expected behavior. A positive value specifies a warning, which means the function performed as expected, but a condition arose that may require attention.

Use the [mcStatusToString](#) function of the ECU M&C API to obtain a descriptive string for the return value.

Description

`mcDAQInitialize` does not start the transmission of the DAQ lists on the ECU. This enables you to use `mc SetProperty` to change the properties of a Measurement task. After you change properties, use `mcDAQStartStop` to start the transmission of the Measurement task.

mcDAQListInitialize

Purpose

Defines a DAQ list on a specific DAQ list number and initializes the Measurement task for the specified Measurement channel list. Initializes a Measurement task for the specified Measurement channel list.

Format

```
mcTypeStatus      mcDAQListInitialize(
                    cstr MeasurementNames,
                    mcTypeTaskRef ECURefNum,
                    i16 DAQListNo,
                    i32 DAQMode,
                    u32 DTO_ID,
                    f64 SampleRate,
                    mcTypeTaskRef *DAQRefNum);
```

Input

MeasurementNames	Comma-separated list of Measurement names to initialize as a task. You can type in the channel list as a string constant or you can obtain the list from an A2L database file by using the mcGetNames function.
ECURefNum	ECURefNum is the task reference which links to the selected ECU. This reference is originally returned from mcECUSelectEx .
DAQListNo	DAQListNo specifies which DAQ list entry number should be used for the defined Measurement channel list for the selected ECU. To query the available amount of DAQ List numbers on the ECU use mcPropECU_NumberOfDefinedDAQLists with the function mcGetProperty . To query the defined DAQ list numbers use mcPropECU_DAQListNumbers with mcGetProperty .
DAQMode	DAQMode specifies the I/O mode for the task. For an overview of the I/O modes, including figures, refer to the Basic Programming Model section of Chapter 4, Using the ECU M&C API .

mcDAQModeDAQList

Data is transmitted automatically by the ECU using DAQ lists. The data can be read back with the [mcDAQRead](#) as Single point data using sample rate = 0 or as waveform using a

sample rate > 0. Input channel data is received from the DAQ messages.

mcDAQModePolling

DTO_ID	In this mode the data from the Measurement task are uploaded from the ECU whenever <code>mcDAQRead</code> is called. DTO_ID is the CAN identifier for the Data Transmission Object (DTO) used to transmit the data from the DAQ lists to the host. The default value is -1 which means that the DTO ID used to transmit the DAQ list data is the same that is used for the rest of the CCP communication.
SampleRate	SampleRate specifies the timing to use for samples of the (NI-CAN) task. The sample rate is specified in Hertz (samples per second). A sample rate of zero means to sample immediately. For a DAQMode of <code>mcDAQModeDAQList</code> , SampleRate of zero means that <code>mcDAQRead</code> returns a single sample from the most recent messages received, and greater than zero means that <code>mcDAQRead</code> returns samples timed at the specified rate. For DAQMode of <code>mcDAQModePolling</code> , SampleRate is ignored.

Output

DAQRefNum	DAQRefNum is the reference handle for the Measurement task. Use this Measurement task reference in subsequent M&C DAQ functions for this task.
-----------	--

Return Value

The return value indicates the status of the function call as a signed 32-bit integer. Zero means the function executed successfully. A negative value specifies an error, which means the function did not perform the expected behavior. A positive value specifies a warning, which means the function performed as expected, but a condition arose that may require attention.

Use the `mcStatusToString` function of the ECU M&C API to obtain a descriptive string for the return value.

Description

If an ECU offers a reduced and specific range of DAQ list entry numbers use the `mcDAQListInitialize` function to setup your Measurement list. `mcDAQListInitialize` does not start the transmission of the DAQ lists from the ECU to the application or vice versa through CCP or XCP. This enables you to use `mcSetProperty` to change the properties of a Measurement task. After you change properties use `mcDAQStartStop` to start the communication for the Measurement task. To query the available DAQ list entry numbers use `mcGetProperty` with the property `mcPropECU_DAQListNumbers`.

mcDAQRead

Purpose

Reads samples from a Measurement task. Samples are obtained from received CAN messages.

Format

```
mcTypeStatus      mcDAQRead (
                    mcTypeTaskRef DAQRefNum,
                    u32 NumberOfSamplesToRead,
                    mcTypeTimestamp *StartTime,
                    mcTypeTimestamp *DeltaTime,
                    f64 *SampleArray,
                    u32 *NumberOfSamplesReturned);
```

Input

DAQRefNum DAQRefNum is the task reference from the previous Measurement task function. The task reference is originally returned from [mcDAQInitialize](#), and then reused by subsequent Measurement task functions.

NumberOfSamplesToRead Specifies the number of samples to read for the task. For single-sample input, pass 1 to this parameter. If the initialized sample rate is zero, you must pass NumberOfSamplesToRead no greater than 1. SampleRate of zero means mcDAQRead immediately returns a single sample from the most recent message(s) received.

Output

StartTime Returns the time of the first CAN sample in SampleArray. This parameter is optional. If you pass NULL for the StartTime parameter, the mcDAQRead function proceeds normally. If the initialized sample rate is greater than zero, the StartTime is determined by the sample timing. If the initialized SampleRate is zero, the StartTime is zero, because the most recent sample is returned regardless of timing. StartTime uses the mcTypeTimestamp data type. The mcTypeTimestamp data type is a 64-bit unsigned integer compatible with the Microsoft Win32 FILETIME type. This absolute time is kept in a Coordinated Universal Time (UTC)

format. UTC time is loosely defined as the current date and time of day in Greenwich, England. Microsoft defines its UTC time (`FILETIME`) as a 64-bit counter of 100 ns intervals that have elapsed since 12:00 a.m., January 1, 1601. Because `mcTypeTimestamp` is compatible with Win32 `FILETIME`, you can pass it into the Win32 `FileTimeToLocalFileTime` function to convert it to the local time zone, and then pass the resulting local time to the Win32 `FileTimeToSystemTime` function to convert to the Win32 `SYSTEMTIME` type. `SYSTEMTIME` is a struct with fields for year, month, day, and so on. For more information on Win32 time types and functions, refer to the Microsoft Win32 documentation.

`DeltaTime`

Returns the time between each sample in `SampleArray`. This parameter is optional. If you pass `NULL` for the `DeltaTime` parameter, the `mcDAQRead` function proceeds normally. If the initialized sample rate is greater than zero, the `DeltaTime` is determined by the sample timing. If the initialized sample rate is zero, the `DeltaTime` is zero, because the most recent sample is returned regardless of timing. `DeltaTime` uses the `mcTypeTimestamp` data type. The delta time is a relative 64-bit counter of 100 ns intervals, not an absolute UTC time. Nevertheless, you can use functions like the Win32 `FileTimeToSystemTime` function to convert to the Win32 `SYSTEMTIME` type. In addition, you can use the 32-bit `LowPart` of `DeltaTime` to obtain a simple 100 ns count, because values for `SampleRate` as slow as 0.4 Hz are still limited to a 32-bit 100 ns count.

`SampleArray`

Returns a 2D array, one array for each channel initialized in the task. The array of each channel must have `NumberOfSamplesToRead` entries allocated. The order of channel entries in `SampleArray` is the same as the order in the original `ChannelList`. If you need to determine the number of channels in the task after initialization, get the `mcPropDAQ_NumChannels` property for the task reference. If no message has been received since you started the task, 0 is returned as default value for of the channel in all entries of `SampleArray`.

`NumberOfSamplesReturned`

`NumberOfSamplesReturned` indicates the number of samples returned for each channel in `SampleArray`. The remaining entries are left unchanged (zero).

Return Value

The return value indicates the status of the function call as a signed 32-bit integer. Zero means the function executed successfully. A negative value specifies an error, which means the function did not perform the expected behavior. A positive value specifies a warning, which means the function performed as expected, but a condition arose that may require attention.

Use the `mcStatusToString` function of the ECU M&C API to obtain a descriptive string for the return value.

Description

If the initialized `SampleRate` is greater than zero, this function returns an array of samples, each of which indicates the value of the CAN channel at a specific point in time. The `mcDAQRead` function waits for these samples to arrive in time before returning. In other words, the `SampleRate` specifies a virtual clock that copies the most recent value from CAN messages for each sample time. The changes in sample values from message to message enable you to view the channel over time, such as for comparison with other CAN or DAQ input channels. To avoid internal waiting, you can use `mcGetProperty` to obtain `nctPropSamplesPending` property, and pass that as the `NumberOfSamplesToRead` parameter to `mcDAQRead`.

If the initialized `SampleRate` is zero, `mcDAQRead` immediately returns a single sample from the most recent message(s) received. For this single-point read, you must pass the `NumberOfSamplesToRead` parameter as 1. You can use the return value of `mcDAQRead` to determine whether a new message has been received since the previous call to `mcDAQRead` (or `mcDAQStartStop`). If no message has been received, the warning code `CanWarnOldData` is returned. If a new message has been received, the success code 0 is returned. If no message has been received since you started the task, the default value of the channel (`nctPropChanDefaultValue`) is returned in all entries of `SampleArray`.

mcDAQReadTimestamped

Purpose

Reads timestamped samples from a DAQ task initialized with the selected mode of `mcDAQModeDAQListTimeStamped`.

Format

```
mcTypeStatus      mcDAQReadTimestamped(
                    mcTypeTaskRef DAQRefNum,
                    u32  NumberOfSamplesToRead,
                    __int64 *TimestampArray,
                    double *SampleArray,
                    u32  *NumberOfSamplesReturned);
```

Input

`DAQRefNum` `DAQRefNum` is the task reference that links to the selected measurement task. This reference is originally returned from [mcDAQInitialize](#) or [mcDAQListInitialize](#).

`NumberOfSamplesToRead` Specifies the number of samples to read for the task.

Output

`TimestampArray` Returns the time at which each corresponding sample in `SampleArray` was received in a CAN message. The timestamps are returned as an array of arrays (2D array), one array for each channel initialized in the task. The array of each channel must have `NumberOfSamplesToRead` entries allocated. For example, if you call [mcDAQInitialize](#) with `ChannelList` of `myDAQ1,myDAQ2`, then call `mcDAQReadTimestamped` with `NumberOfSamplesToRead` of 20, both `TimestampArray` and `SampleArray` must be allocated as:

```
__int64 mcTypeTimestamp TimestampArray[2][20];
double SampleArray[2][20];
```

The order of channel entries in `TimestampArray` is the same as the order in the original DAQ channel list. To determine the number of channels in the DAQ task after initialization, get the `mcPropDAQ_NumChannels` property for the DAQ task reference. Each timestamp in `TimestampArray` uses the `__int64` data type compatible with the Microsoft Win32 FILETIME type. This

absolute time is kept in a Coordinated Universal Time (UTC) format. UTC time is loosely defined as the current date and time of day in Greenwich, England. Microsoft defines its UTC time (FILETIME) as a 64-bit counter of 100 ns intervals that have elapsed since 12:00 a.m., January 1, 1601. Because the timestamp is compatible with Win32 FILETIME, you can pass it into the Win32 `FileTimeToLocalFileTime` function to convert it to the local timezone, and then pass the resulting local time to the Win32 `FileTimeToSystemTime` function to convert to the Win32 SYSTEMTIME type. SYSTEMTIME is a struct with fields for year, month, day, and so on. For more information about Win32 time types and functions, refer to the Microsoft Win32 documentation.

`SampleArray`

`SampleArray` returns the sample value(s) for each received CAN message. The samples are returned as an array of arrays (a 2D array), one array for each channel initialized in the DAQ task. The array of each channel must have `NumberOfSamplesToRead` entries allocated. You must allocate `SampleArray` exactly as `TimestampArray`, and the order of channel entries is the same for both.

`NumberOfSamplesReturned`

Indicates the number of samples returned for each channel in `SampleArray`, and the number of timestamps returned for each channel in `TimestampArray`. The remaining entries are left unchanged (zero).

Return Value

The return value indicates the status of the function call as a signed 32-bit integer. Zero means the function executed successfully. A negative value specifies an error, which means the function did not perform the expected behavior. A positive value specifies a warning, which means the function performed as expected, but a condition arose that may require attention.

Use the `mcStatusToString` function of the ECU M&C API to obtain a descriptive string for the return value.

Description

Each returned sample corresponds to a received CAN message for the measurement channels initialized in the DAQ channel list. For each sample, `mcDAQReadTimestamped` returns the sample value and a timestamp that indicates when the message was received. Because the timing of samples returned by `mcDAQReadTimestamped` is determined by when the message is received, the initialized sample rate is not used.

The function does not wait for messages, but instead returns samples from the messages received since the previous call to `mcDAQReadTimestamped`. The number of samples returned is indicated in the `NumberOfSamplesReturned` output, up to a maximum of `NumberOfSamplesToRead` messages. If no new message has been received, `NumberOfSamplesReturned` is 0, and the return value indicates success.

mcDAQStartStop

Purpose

Starts the transmission of the DAQ lists assigned to the Measurement task on the ECU.

Format

```
mcTypeStatus      mcDAQStartStop(
                    mcTypeTaskRef DAQRefNum,
                    u32 StartStopMode);
```

Input

DAQRefNum	DAQRefNum is the task reference from the previous Measurement task function. The task reference is originally returned from mcDAQInitialize , and then reused by subsequent Measurement task functions.
StartStopMode	<p>StartStopMode indicates the type of function to be performed:</p> <p>0—mcStartStopModeStop</p> <p>Configures the ECU to stop transmitting a DAQ task. If stopped, properties of the DAQ task can be changed using mc SetProperty. This function is performed automatically before mcDAQClear.</p> <p>1—mcStartStopModeStart</p> <p>Configures the ECU to start sending data for a Measurement task. Ensure that the DAQ list has not yet been transferred to the ECU first. Once started, properties of the DAQ list can no longer be changed using mc SetProperty. This function is performed automatically before the first read of the DAQ list with mcDAQRead.</p> <p>2—mcStartStopModeTransmitDAQ</p> <p>Transfers the DAQ list to the ECU, but does not start it. For example, use this mode if you want to change the session status before starting the DAQ list. For some ECUs, this is necessary.</p>

Output

Return Value

The return value indicates the status of the function call as a signed 32-bit integer. Zero means the function executed successfully. A negative value specifies an error, which means the function did not perform the expected behavior. A positive value specifies a warning, which means the function performed as expected, but a condition arose that may require attention.

Use the `mcStatusToString` function of the ECU M&C API to obtain a descriptive string for the return value.

Description

`mcDAQStartStop` is an optional command to start or stop communication for an M&C Measurement task. If you do not perform `mcDAQStartStop` (with the parameter `mcStartStopModeStart`) before using `mcDAQRead` the Measurement task is started by the first call of `mcDAQRead`. After you start the transmission of the DAQ lists, you can no longer change the configuration of the Measurement task with `mcSetProperty`. You must call `mcDAQStartStop` (with the parameter `mcStartStopModeStop`) first.

mcDAQWrite

Purpose

Writes samples to an ECU DAQ list.

Format

```
mcTypeStatus      mcDAQWrite (
                    mcTypeTaskRef DAQRefNum,
                    u32 NumberOfSamplesToWrite,
                    f64 *SampleArray);
```

Input

DAQRefNum	DAQRefNum is the task reference from the previous Measurement task function. The task reference is originally returned from mcDAQInitialize , and then reused by subsequent Measurement task functions.
NumberOfSamplesToWrite	NumberOfSamplesToWrite specifies the number of samples to write for the ECU MC DAQ task to the ECU DAQ list. For single-sample output, pass 1 to this parameter. The initialized DAQ sample rate must be set to zero. A SampleRate of zero means mcDAQWrite immediately writes a single sample to the ECU when calling the mcDAQWrite function. You must pass NumberOfSamplesToWrite no greater than 1.
*SampleArray	SampleArray specifies a 2D array, one array for each channel initialized in the task. The array of each channel must have NumberOfSamplesToWrite entries allocated. The order of channel entries in SampleArray is the same as the order in the original ChannelList. If you must determine the number of channels in the task after initialization, get the mcPropDAQ_NumChannels property for the task reference.

Output

Return Value

The return value indicates the status of the function call as a signed 32-bit integer. Zero means the function executed successfully. A negative value specifies an error, which means the function did not perform the expected behavior. A positive value specifies a warning, which means the function performed as expected, but a condition arose that may require attention.

Use the [mcStatusToString](#) function of the ECU M&C API to obtain a descriptive string for the return value.

Description

For XCP STIM lists (refer to `mcDAQInitialize`), `mcDAQWrite` transfers an array of samples to the ECU. These samples are called *data stimulation packets* (STIM). On the ECU side the STIM processor buffers incoming data stimulation packets. When an event occurs which triggers a DAQ list in data stimulation mode, the buffered data is transferred to the memory on the slave device.

Refer to the *ASAM XCP Part 2 Protocol Layer Specification* for more information on how to configure data stimulation.

mcDatabaseClose

Purpose

Closes a specified A2L Database.

Format

```
mcTypeStatus          mcDatabaseClose (  
                        mcTypeTaskRef *DBRefNum) ;
```

Input

DBRefNum
DBRefNum is the task reference from the initial database task function. The database task reference is originally returned from [mcDatabaseOpen](#).

Output

Return Value

The return value indicates the status of the function call as a signed 32-bit integer. Zero means the function executed successfully. A negative value specifies an error, which means the function did not perform the expected behavior. A positive value specifies a warning, which means the function performed as expected, but a condition arose that may require attention.

Use the [mcStatusToString](#) function of the ECU M&C API to obtain a descriptive string for the return value.

Description

`mcDatabaseClose` must always be the final ECU M&C function called for each database task. If you do not use the `mcDatabaseClose` function, the remaining task configurations can cause problems in the execution of subsequent Measurement and Calibration applications.

mcDatabaseOpen

Purpose

Opens a specified A2L Database.

Format

```
mcTypeStatus      mcDatabaseOpen (
                    cstr Database,
                    mcTypeTaskRef *DBRefNum) ;
```

Input

Database	Database is a path to an A2L database file from which to get Measurement or calibration channel names. The file must use a .A2L extension. You can generate A2L database files with several 3rd party tools.
----------	--

Output

DBRefNum	DBRefNum is the task reference from the initial database task function. The database task reference is originally returned from mcDatabaseOpen.
----------	---

Return Value

The return value indicates the status of the function call as a signed 32-bit integer. Zero means the function executed successfully. A negative value specifies an error, which means the function did not perform the expected behavior. A positive value specifies a warning, which means the function performed as expected, but a condition arose that may require attention.

Use the [mcStatusToString](#) function of the ECU M&C API to obtain a descriptive string for the return value.

Description

The mcDatabaseOpen function does not start communication. This enables you to query all defined ECU names in the A2L Database using the [mcGetNames](#) function and selecting the property value ECU Names.

To use the ECU M&C Toolkit on a LabVIEW RT system, you must download your ASAM MCD 2MC database (*.A2L) file to the RT target.

mcDownload

Purpose

Downloads data to an ECU.

Format

```
mcTypeStatus      mcDownload(
                    mcTypeTaskRef ECURefNum,
                    mcAddress Address,
                    u32 BlockSize
                    u8 *Data);
```

Input

ECURefNum	ECURefNum is the task reference which links to the selected ECU. This reference is originally returned from mcECUSelectEx .
Address	Configures the target address for the download operation in the ECU. mcAddress is a C struct consisting of: <p>Address Specifies the address part of the target address.</p> <p>Extension Extension contains the extension part of the target address.</p>
BlockSize	BlockSize determines the size of the data block to be downloaded.

Output

Data	Data pointer to the information to be downloaded.
------	---

Return Value

The return value indicates the status of the function call as a signed 32-bit integer. Zero means the function executed successfully. A negative value specifies an error, which means the function did not perform the expected behavior. A positive value specifies a warning, which means the function performed as expected, but a condition arose that may require attention.

Use the [mcStatusToString](#) function of the ECU M&C API to obtain a descriptive string for the return value.

Description

`mcDownload` downloads data to an ECU. The data is stored starting at the selected **Address** and **Extension** in the ECU memory. The function can download more than 5 data bytes to the ECU.

If you are using the CCP protocol and the selected `BlockSize` is higher than 5 bytes, `mcDownload` performs several CCP DNLOAD commands until all data bytes are downloaded to the ECU. `mcDownload` implements the CCP DNLOAD command defined by the CCP specification.

If you are using the XCP protocol, the `Data` block of the specified `BlockSize` is copied into the ECU memory, starting at the MTA. The MTA is post-incremented by the number of downloaded data bytes. If the slave device does not support Block Transfer Mode, all downloaded data is transferred in a single command packet. If Block Transfer Mode is supported, the downloaded data is transferred in multiple command packets. For the slave however, there might be limitations concerning the maximum number of consecutive command packets, so the number of data elements may be within a limited range. The master device has two additional consecutive `DOWNLOAD_NEXT` command packets. The slave device will acknowledge only the last `DOWNLOAD_NEXT` command packet. The separation time between the command packets and the maximum number of packets are specified in the response for the `CONNECT` command.

mcECUConnect

Purpose

Establishes communication to the selected ECU through CCP or XCP. After a successful ECU Connect you can create a Measurement task or read/write a Characteristic.

Format

```
mcTypeStatus          mcECUConnect (
                        mcTypeTaskRef ECURefNum) ;
```

Input

ECURefNum ECURefNum is the task reference which links to the selected ECU. This reference is originally returned from [mcECUSelectEx](#).

Output

Return Value

The return value indicates the status of the function call as a signed 32-bit integer. Zero means the function executed successfully. A negative value specifies an error, which means the function did not perform the expected behavior. A positive value specifies a warning, which means the function performed as expected, but a condition arose that may require attention.

Use the [mcStatusToString](#) function of the ECU M&C API to obtain a descriptive string for the return value.

Description

`mcECUConnect` implements the CCP or XCP CONNECT command. It establishes a logical connection to an ECU, using the provided ECU Reference handle `ECURefNum`. Unless a slave device (ECU) is unconnected, it must not execute or respond to any command sent by the application. The only exception to this rule is the Test command, to which the CCP or XCP slave with the specific address may return an acknowledgement. Only a single CCP or XCP slave can be connected to the application at a time.

mcECUCreate

Purpose

Creates an ECU object in memory.

Format

```
mcTypeStatus      mcECUCreate(
                    mcTypeTaskRef DBRefNum,
                    cstr ECUName,
                    char *Interface,
                    i32 ByteOrder,
                    u32 CRO_ID,
                    u32 DTO_ID,
                    u16 StationAddress,
                    u32 BaudRate,
                    mcTypeTaskRef *ECURefNum);
```

Input

DBRefNum	DBRefNum is the task reference from the initial database task function. The database task reference is originally returned from mcDatabaseOpen .
ECUName	Identifies the ECU object. Use this name as reference in mcMeasurementCreate to create a DAQ list on the ECU.
Interface	Specifies the protocol and optional interface to use for this task.
ByteOrder	Sets the byte order of the CCP slave device: 0—MSB_LAST The CCP Slave device uses the MSB_LAST (Intel) byte ordering. 1—MSB_FIRST The CCP Slave device uses the MSB_FIRST (Motorola) byte ordering.
CRO_ID	Sets the Command Receive Object (CRO) CAN Identifier for CCP, or XCP on CAN, which is used to send commands and data from the host to the slave device.
DTO_ID	Sets the Data Transfer Object (DTO) CAN Identifier for CCP, or XCP on CAN, which is used to send commands and data from the slave device to the host.
StationAddress	Sets the slave device station address. CCP is based on the idea that several ECUs can share the same CAN Arbitration IDs for CCP communication. To avoid communication conflicts, CCP defines a station address that must be unique for all ECUs sharing the

BaudRate	<p>same CAN Arbitration IDs. Unless an ECU has been addressed by its station address, the ECU must not react to CCP commands sent by the CCP master.</p> <p>Sets the CAN baud rate in use by the selected interface. This property applies to all tasks initialized with the NI-CAN or NI-XNET interface. You can specify the following basic baud rates as the numeric rate: 33333, 83333, 100000, 125000, 200000, 250000, 400000, 500000, 800000, and 1000000. You can specify advanced baud rates as 8000XXYY hex, where YY is the value of Bit Timing Register 0 (BTR0), and XX is the value of Bit Timing Register 1 (BTR1). For more information, refer to the Interface Properties dialog in MAX.</p>
----------	--

Output

ECURefNum	ECURefNum is the task reference that links to the selected ECU.
-----------	---

Return Value

The return value indicates the status of the function call as a signed 32-bit integer. Zero means the function executed successfully. A negative value specifies an error, which means the function did not perform the expected behavior. A positive value specifies a warning, which means the function performed as expected, but a condition arose that may require attention.

Use the [mcStatusToString](#) function of the ECU M&C API to obtain a descriptive string for the return value.

Description

The function `mcECUCreate` is used to create an ECU object in memory instead of referring to a predefined ECU of an A2L database.

`Interface` is the name of the protocol and interface the selected ECU task will use. This string uses the syntax `XXX:YYY`, where `X` defines the selected protocol. The following strings may be used as `Y`:

- String `CCP` refers using the CAN Calibration Protocol (CCP)
- String `XCP` refers using the Universal Measurement and Calibration Protocol (XCP)

Using NI-CAN

If you are using the CCP protocol with NI-CAN hardware, `YYY` can be associated with a defined NI-CAN interface (CAN0, CAN1, up to CAN63). CAN network interface names are associated with physical CAN ports using the Measurement and Automation Explorer (MAX). For example, if you are using the CCP protocol on NI-CAN interface CAN1, the value passed to `Interface` is `CCP:CAN1`. The special string values “CAN256” and

“CAN257” refer to virtual interfaces. Refer to the *NI-CAN Hardware and Software User Manual* for detailed information on how to use virtual NI-CAN ports.

If you are using the XCP protocol, *YYY* can be associated with a XCP transport layer. The transport layers may be defined as follows:

- CAN xx
- TCP
- UDP

If you select CAN as the transport layer you must specify the NI-CAN interface (CAN0, CAN1, up to CAN63). CAN network interface names are associated with physical CAN ports using the Measurement and Automation Explorer (MAX). For example, if you are using the XCP on NI-CAN interface CAN2 the value passed to `Interface` is `XCP:CAN2`. If you are using the XCP on UDP the value passed to `Interface` is `XCP:UDP`. If you are using the XCP on TCP the value passed to `Interface` is `XCP:TCP`. The special string values “CAN256” and “CAN257” refer to virtual interfaces. Refer to the *NI-CAN Hardware and Software User Manual* for detailed information on how to use virtual NI-CAN ports.

Using NI-XNET

If you are using NI-XNET hardware and select the *xxx:yyy* syntax, the ECU M&C Toolkit uses the XNET NI-CAN compatibility library (XCL) internally if the XNET interface is defined in MAX under **NI-CAN Devices**. To force use of the native XNET API, you must define a unique interface name that differs from the NI-CAN-compatible interface name under **XNET Devices**, or use the *xxx:yyy@ni_genie_nixnet* syntax. The interface name is related to the NI-XNET hardware naming under **Devices and Interfaces** in MAX. The extension *ni_genie_nixnet* directs the ECU M&C Toolkit to use the native NI-XNET API.

CompactRIO or R Series

If you are using CompactRIO or R Series hardware, you must provide a bitfile that handles the CAN communication between the host system and the FPGA. To access the CAN module on the FPGA, you must specify the bitfile name after the @ (for example, *CCP:CAN1@MyBitfile.lvbitx*). To specify a special RIO target, you can specify that target by its name followed by the bitfile name (for example, *XCP:CAN1@RIO1,MyBitfile.lvbitx*). Currently, only a single CAN interface is supported. RIO1 defines the RIO target name as defined in your LabVIEW Project definition. The *lvbitx* filename represents the filename and location of the bitfile on the host. You may use just the filename without the folder if the bitfile is in the same folder as the LabVIEW Project (**.lvproj*).

mcECUDeselect

Purpose

Deselects an ECU and invalidates the ECU reference handle.

Format

```
mcTypeStatus          mcECUDeselect (
                        mcTypeTaskRef *ECURefNum) ;
```

Input

ECURefNum ECURefNum is the task reference which links to the selected ECU. This reference is originally returned from [mcECUSelectEx](#).

Output

Return Value

The return value indicates the status of the function call as a signed 32-bit integer. Zero means the function executed successfully. A negative value specifies an error, which means the function did not perform the expected behavior. A positive value specifies a warning, which means the function performed as expected, but a condition arose that may require attention.

Use the [mcStatusToString](#) function of the ECU M&C API to obtain a descriptive string for the return value.

Description

`mcECUDeselect` deselects the ECU and clears all internal driver data stored for this ECU. After calling this function it is no longer possible to communicate with the specified ECU. The task reference `ECURefNum` is transferred into a database handle `DBRefNum`.

mcECUDisconnect

Purpose

Disconnects CCP or XCP communication to the selected ECU.

Format

```
mcTypeStatus          mcECUDisconnect (
                        mcTypeTaskRef  ECURefNum) ;
```

Input

ECURefNum ECURefNum is the task reference which links to the selected ECU. This reference is originally returned from [mcECUSelectEx](#).

Output

Return Value

The return value indicates the status of the function call as a signed 32-bit integer. Zero means the function executed successfully. A negative value specifies an error, which means the function did not perform the expected behavior. A positive value specifies a warning, which means the function performed as expected, but a condition arose that may require attention.

Use the [mcStatusToString](#) function of the ECU M&C API to obtain a descriptive string for the return value.

Description

`mcECUDisconnect` implements the CCP or XCP command DISCONNECT. `mcECUDisconnect` disconnects the specified CCP or XCP slave from the actual communication and ends the calibration session. When the calibration session is terminated, all CCP or XCP DAQ lists of the device are stopped and cleared and the protection masks of the device are set to their default values.

`mcECUDisconnect` is an optional command as disconnecting from the ECU is performed by the function [mcECUDeselect](#).

mcECUSelectEx

Purpose

Selects an ECU from the names stored in an A2L database.

Format

```
mcTypeStatus      mcECUSelectEx (
                    mcTypeTaskRef DBRefNum,
                    cstr ECUName,
                    cstr Interface,
                    mcTypeTaskRef *ECURefNum);
```

Input

DBRefNum	DBRefNum is the task reference from the initial database task function. The database task reference is originally returned from mcDatabaseOpen .
ECUName	ECUName is the selected ECU name out of an A2L Database file with which to initialize all subsequent tasks.
Interface	Specifies the protocol and optional interface to use for this task.

Output

ECURefNum	ECURefNum is the task reference which links to the selected ECU.
-----------	--

Return Value

The return value indicates the status of the function call as a signed 32-bit integer. Zero means the function executed successfully. A negative value specifies an error, which means the function did not perform the expected behavior. A positive value specifies a warning, which means the function performed as expected, but a condition arose that may require attention.

Use the [mcStatusToString](#) function of the ECU M&C API to obtain a descriptive string for the return value.

Description

`mcECUSelectEx` creates an ECU reference handle to the selected ECU name. The `mcECUSelectEx` function does not start communication. This enables you to use [mcSetProperty](#) to change the properties of an ECU task. After you change properties use [mcECUConnect](#) to start communication for the task and logically connect to the selected ECU.

`Interface` is the name of the protocol and interface the selected ECU task will use. This string uses the syntax `XXX:YYY`, where `X` defines the selected protocol. The following strings may be used:

- String `CCP` refers using the CAN Calibration Protocol (CCP)
- String `XCP` refers using the Universal Measurement and Calibration Protocol (XCP)

If you are using the CCP protocol, `YYY` can be associated with a defined NI-CAN interface (CAN0, CAN1, up to CAN63). CAN network interface names are associated with physical CAN ports using the Measurement and Automation Explorer (MAX). For example, if you are using the CCP protocol on NI-CAN interface CAN1, the value passed to `Interface` is `CCP:CAN1`. The special string values “CAN256” and “CAN257” refer to virtual interfaces. Refer to the *NI-CAN Hardware and Software User Manual* for detailed information on how to use virtual NI-CAN ports.

If you are using the XCP protocol, `YYY` can be associated with a XCP transport layer. The transport layers may be defined as follows:

- `CANxx`
- `TCP`
- `UDP`

Using NI-CAN

If you select CAN as the transport layer you must specify the NI-CAN interface (CAN0, CAN1, up to CAN63). CAN network interface names are associated with physical CAN ports using the Measurement and Automation Explorer (MAX). For example, if you are using the XCP on NI-CAN interface CAN2 the value passed to `Interface` is `XCP:CAN2`. If you are using the XCP on UDP the value passed to `Interface` is `XCP:UDP`. If you are using the XCP on TCP the value passed to `Interface` is `XCP:TCP`. The special string values “CAN256” and “CAN257” refer to virtual interfaces. Refer to the *NI-CAN Hardware and Software User Manual* for detailed information on how to use virtual NI-CAN ports.

Using NI-XNET

If you are using NI-XNET hardware and select the `xxx:yyy` syntax, the ECU M&C Toolkit uses the XNET NI-CAN compatibility library (XCL) internally if the XNET interface is defined in MAX under **NI-CAN Devices**. To force use of the native XNET API, you must define a unique interface name that differs from the NI-CAN-compatible interface name under **XNET Devices**, or use the `xxx:yyy@ni_genie_nixnet` syntax. The interface name is related to the NI-XNET hardware naming under **Devices and Interfaces** in MAX. The extension `ni_genie_nixnet` directs the ECU M&C Toolkit to use the native NI-XNET API.

CompactRIO or R Series

If you are using CompactRIO or R Series hardware, you must provide a bitfile that handles the CAN communication between the host system and the FPGA. To access the CAN module on the FPGA, you must specify the bitfile name after the @ (for example, *CCP:CAN1@MyBitfile.lvbitx*). To specify a special RIO target, you can specify that target by its name followed by the bitfile name (for example, *XCP:CAN1@RIO1,MyBitfile.lvbitx*). Currently, only a single CAN interface is supported. RIO1 defines the RIO target name as defined in your LabVIEW Project definition. The *lvbitx* filename represents the filename and location of the bitfile on the host. You may use just the filename without the folder if the bitfile is in the same folder as the LabVIEW Project (**.lvproj*).

mcEventCreate

Purpose

Creates an Event object in memory.

Format

```
mcTypeStatus      mcEventCreate (
                    mcTypeTaskRef ECURefNum,
                    cstr EventChannelName,
                    u8 EventChannelNumber);
```

Input

ECURefNum	ECURefNum is the task reference that links to the selected ECU. This reference is originally returned from <code>mcECUCreate</code> .
EventChannelName	EventChannelName identifies the Event Channel object.
EventChannelNumber	EventChannelNumber identifies the number of the Event Channel. The event channel number specifies the generic signal source that effectively determines the data transmission timing. To allow a reduction of the desired transmission rate, a prescaler may be applied to the Event Channel. The prescaler value factor must be greater than or equal to 1 to use <code>mcSetProperty</code> using <code>mcPropDAQ_Prescaler</code> .

Output

Return Value

The return value indicates the status of the function call as a signed 32-bit integer. Zero means the function executed successfully. A negative value specifies an error, which means the function did not perform the expected behavior. A positive value specifies a warning, which means the function performed as expected, but a condition arose that may require attention.

Use the `mcStatusToString` function of the ECU M&C API to obtain a descriptive string for the return value.

Description

Use the function `mcEventCreate` to create an Event object in memory instead of referring to a predefined Event Channel in the A2L database. Assign the event channel object by name to a DAQ List in `mcMeasurementCreate`.

mcGeneric

Purpose

Sends a generic command.

Format

```
mcTypeStatus      mcGeneric (
                    mcTypeTaskRef ECURefNum,
                    u8 Command,
                    u8 *Data,
                    u32 DataSize,
                    u32 Timeout,
                    u8 *ErrorCode,
                    u8 *ReturnValue,
                    u32 *ReturnValueSize);
```

Input

ECURefNum	ECURefNum is the task reference which links to the selected ECU. This reference is originally returned from mcECUSelectEx .
Command	Command is the CCP command code to send to the ECU.
Data	Data contains the parameters of the command as an array of bytes. For more information about the parameters of the (user defined) commands implemented in the ECU, refer to the documentation for the ECU.
DataSize	DataSize defines the number of bytes (the array size) passed in the input parameter Data.
Timeout	Timeout specifies the maximum number of milliseconds to wait for a response from the ECU. If the Timeout expires before an ECU response occurs, the error <code>mcErrorTimeout</code> is returned.

Output

ErrorCode	ErrorCode describes the error returned from the ECU during the communication.
ReturnValue	ReturnValue may contain an array of bytes returned from the ECU as a response to the command sent to the ECU.
ReturnValueSize	ReturnValueSize contains the number of bytes returned from the ECU passed to ReturnValue.

Return Value

The return value indicates the status of the function call as a signed 32-bit integer. Zero means the function executed successfully. A negative value specifies an error, which means the function did not perform the expected behavior. A positive value specifies a warning, which means the function performed as expected, but a condition arose that may require attention.

Use the `mcStatusToString` function of the ECU M&C API to obtain a descriptive string for the return value.

Description

`mcGeneric` can be used to send commands to the ECU that are not defined by the CCP or XCP specification. The command code in `Command` and the parameters of this command defined in `Data` are sent to the ECU, and the data returned by the ECU is passed to the parameter `ReturnValue`. Since the ECU M&C driver has no knowledge of the parameters of the command and their data types, all parameters and return values are passed as an array of bytes. Therefore you are responsible for the correct type casting of all parameters and return values of this command. Make sure that all parameters are passed in the correct byte ordering for this function. For more information about the (user defined) commands and their parameters refer to the documentation for the ECU.

mcGetNames

Purpose

Retrieves a comma-separated list of ECU, Measurement, or Characteristic names from a specified A2L database.

Format

```
mcTypeStatus      mcGetNames (
                    mcTypeTaskRef RefNum,
                    u32 Type,
                    cstr ECUName,
                    u32 SizeOfNamesList,
                    str NameList);
```

Input

RefNum	RefNum is any ECU M&C task reference which consists of a valid link to the opened A2L database (DBRefNum), a selected ECU (ECURefNum) or a Measurement task (DAQRefNum). RefNum must be valid for the related Type.
Type	Specifies the Type of names to return. <ul style="list-style-type: none"> 0—mcTypeECUNames Return list of ECU names. You can pass one of the returned names to mcECUSelectEx. 1—mcTypeMeasurementNames Return list of Measurement names. You can pass the returned NamesList to mcDAQInitialize. 2—mcTypeCharacteristicNames Return list of Characteristic Names. You can pass a single name out of the NamesList to mcCharacteristicWrite or mcCharacteristicRead. 3—mcTypeEventChannelNames Return list of Event Channel names.
ECUName	If the Type = mcTypeMeasurementNames or Type = mcTypeCharacteristicNames and RefNum contains a DBRefNum , the corresponding ECU name must be referenced in order to access ECU specific properties. If RefNum contains an ECURefNum or DAQRefNum the parameter ECUName is ignored and can be set to NULL.

`SizeOfNamesList` Size of the buffer provided to take the names list. After calling `mcGetNamesLength`, you can allocate an array of size `SizeOfNamesList`, and then pass that array to `mcGetNames` using the same input parameters. This ensures that `mcGetNames` will return all names without error.

Output

`NameList` Returns the comma-separated list of names specified by `Type`.

Return Value

The return value indicates the status of the function call as a signed 32-bit integer. Zero means the function executed successfully. A negative value specifies an error, which means the function did not perform the expected behavior. A positive value specifies a warning, which means the function performed as expected, but a condition arose that may require attention.

Use the `mcStatusToString` function of the ECU M&C API to obtain a descriptive string for the return value.

Description

Get a comma-separated list of ECU, Measurement, Characteristic, or Event Channel names from a specified A2L database file.

If using `mcGetNames` to query the list of supported event channels on an ECU, the event channels might be stored inside the ECU instead of the A2L file. To query these event channel names from the ECU directly, connect to the ECU using `mcECUConnect` before calling `mcGetNames`.

mcGetNamesLength

Purpose

Retrieves the amount of memory required to store the names returned by `mcGetNames`.

Format

```
mcTypeStatus      mcGetNamesLength(
                    mcTypeTaskRef RefNum,
                    u32 Type,
                    cstr ECUName,
                    u32 *SizeOfNamesList);
```

Input

RefNum	RefNum is any ECU M&C task reference which consists of a valid link to the opened A2L database (DBRefNum), a selected ECU (ECURefNum) or a Measurement task (DAQRefNum). RefNum must be valid for the related Type.
Selector	Specifies the Type of names to return. <ul style="list-style-type: none"> 0—mcTypeECUNames Return list of ECU names. 1—mcTypeMeasurementNames Return list of Measurement names. 2—mcTypeCharacteristicNames Return list of Characteristic Names. 3—mcTypeEventChannelNames Return list of Event Channel names.
ECUName	If the Type = mcTypeMeasurementNames or Type = mcTypeCharacteristicNames and RefNum contains a DBRefNum , the corresponding ECU name must be referenced in order to access ECU specific properties. If RefNum contains an ECURefNum or DAQRefNum the parameter ECUName is ignored and can be set to NULL.

Output

`SizeOfNamesList` Number of bytes required for `mcGetNames` to return all names for the specified `ECUName` and `Type`. After calling `mcGetNamesLength`, you can allocate an array of size `SizeOfNamesList`, then pass that array to `mcGetNames` using the same input parameters. This ensures that `mcGetNames` will return all names without error.

Return Value

The return value indicates the status of the function call as a signed 32-bit integer. Zero means the function executed successfully. A negative value specifies an error, which means the function did not perform the expected behavior. A positive value specifies a warning, which means the function performed as expected, but a condition arose that may require attention.

Use the `mcStatusToString` function of the ECU M&C API to obtain a descriptive string for the return value.

Description

After calling `mcGetNamesLength`, you can allocate an array of size `SizeOfNamesList`, then pass that array to `mcGetNames` using the same input parameters. This ensures that `mcGetNames` will return all names without error.

If using `mcGetNamesLength` to query the length of the list of supported event channels on an ECU, the event channels might be stored inside the ECU instead of the A2L file. To query these event channel names from the ECU directly, connect to the ECU using `mcECUConnect` before calling `mcGetNamesLength`.

mcGetProperty

Purpose

Retrieves a property of the driver, the database, the ECU, a Characteristic, a Measurement, or a Measurement task.

Format

```
mcTypeStatus      mcGetProperty(
                    mcTypeTaskRef RefNum,
                    cstr Name,
                    u32 PropertyID,
                    u32 SizeOfValue,
                    void *Value);
```

Input

RefNum	RefNum is any ECU M&C task reference which consists of a valid link to the opened A2L database (DBRefNum), a selected ECU (ECURefNum) or a Measurement task (DAQRefNum). RefNum must be valid for the related PropertyID type.
Name	Specifies an individual name (ECU name, Measurement channel name, or Characteristic name) within the task.
PropertyID	Selects the property to get. For a description of each property, including its data type and PropertyId, refer to the <i>Properties</i> section.
SizeOfValue	Number of bytes allocated for the Value output. This size normally depends on the data type listed in the description of the property.

Output

Value	Returns the property value. PropertyId determines the data type of the returned value.
-------	--

Return Value

The return value indicates the status of the function call as a signed 32-bit integer. Zero means the function executed successfully. A negative value specifies an error, which means the function did not perform the expected behavior. A positive value specifies a warning, which means the function performed as expected, but a condition arose that may require attention.

Use the [mcStatusToString](#) function of the ECU M&C API to obtain a descriptive string for the return value.

Properties

Table 6-4. Values for PropertyID

Data Type	Name	Description
u32	mcPropCANBaudRate	Returns the CAN Baud rate for CCP or XCP on CAN which is used to send commands and data from the host to the slave device.
u32	mcPropChar_Address	Returns the address of the selected Characteristic in the memory of the ECU.
u32	mcPropChar_ByteOrder	Returns the specified byte order: 0—Intel format Bytes are in little-endian order, with least-significant bit first. 1—Motorola format Bytes are in big-endian order, with most-significant bit first.
u8	mcPropChar_Datatype	Returns the data type of the Characteristic.
u32	mcPropChar_Dimension	Returns the dimension of the Characteristic: 0—0-dimensional: The Characteristic can be accessed (read/write) through a double value. 1—1-dimensional: The Characteristic can be accessed (read/write) through a one-dimensional array of double value. 2—2-dimensional: The Characteristic can be accessed (read/write) through a two-dimensional array of double value.
u8	mcPropChar_Extension	Returns additional address information. For instance it can be used to distinguish different address spaces of an ECU (multi-microcontroller devices).
f64	mcPropChar_Maximum	Returns the Maximum value of the Characteristic.
f64	mcPropChar_Minimum	Returns the Minimum value of the Characteristic.

Table 6-4. Values for PropertyID (Continued)

Data Type	Name	Description
u32	mcPropChar_ReadOnly	Returns if a Characteristic is set to read only. In this case it is not allowed to call <code>mcCharacteristicWrite</code> for this Characteristic.
u32	mcPropChar_Sizes	Returns the Array Sizes for the X and Y directions of the Characteristic.
str	mcPropChar_Unit	Returns the unit string defined for this Characteristic in the A2L database.
u32	mcPropChar_Unit_Size	Returns the number of bytes to be allocated if you call <code>mcGetProperty</code> with the parameter <code>mcPropChar_Unit</code> .
f64	mcPropChar_X_Axis	Returns X-axis values on which the Characteristic is defined. Valid if the selected Characteristic is 1- or 2-dimensional.
f64	mcPropChar_Y_Axis	Returns Y-axis values on which the Characteristic is defined, Valid if the selected Characteristic is 2-dimensional.
u32	mcPropCmd_EXCHANGE_ID	Returns whether or not the EXCHANGE_ID command should be suppressed during connection to the ECU.
u32	mcPropCROID	Returns the CRO CAN Identifier (C ommand R eceive O bject) for CCP or XCP on CAN which is used to send commands and data from the host to the slave device.
u32	mcPropDAQ_DTO_ID	Returns the DTO ID (D ata T ransmission O bject) which is used by the ECU to respond to send data from the DAQ lists to the CCP master.
ncfType Taskref	mcPropDAQ_DTO_Task	NI-CAN task reference to the CAN Task assigned to the DTO ID of the Measurement task.
str	mcPropDAQ_EventChannel Name	Returns the selected event channel name to which the Measurement task is assigned.

Table 6-4. Values for PropertyID (Continued)

Data Type	Name	Description
u32	mcPropDAQ_EventChannelName_Size	Returns the number of bytes to be allocated if you call <code>mcGetProperty</code> with the parameter <code>mcPropDAQ_EventChannelName</code> .
u32	mcPropDAQ_Mode	<p>Returns the selected mode of an M&C Measurement task.</p> <p>0—DAQ List</p> <p>The data is transmitted from the ECU in equidistant time intervals as defined in the A2L database. The data can be read back with <code>mcDAQRead</code> as Single point data using sample rate = 0, or as waveform using a sample rate > 0. Input channel data is received from the DAQ messages. Use <code>mcDAQRead</code> to obtain input samples as single-point, array, or waveform.</p> <p>1—Polling</p> <p>In this mode the data from the Measurement task is uploaded from the ECU whenever <code>mcDAQRead</code> is called.</p>
u32	mcPropDAQ_NumChannels	Returns the number of channels initialized in a DAQ channel list of a M&C Measurement task. This is the number of array entries required when using <code>mcDAQRead</code> .
u16	mcPropDAQ_Prescaler	Prescaler for the Measurement task on the ECU.
f64	mcPropDAQ_SampleRate	Returns the selected Sample Rate in Hz for the M&C Measurement task.
u32	mcPropDAQ_SamplesPending	Returns the number of samples available for read in DAQ tasks defined with sample rate > 0. If this property is queried before the DAQ list is started, it always returns 0. Start the DAQ list first with <code>mcDAQStartStop</code> before you query this property.
str	mcPropDB_Filename	Returns the A2L Database file name with which the task has been opened. The value of this property cannot be changed using <code>mcSetProperty</code> .

Table 6-4. Values for PropertyID (Continued)

Data Type	Name	Description
u32	mcPropDB_Filename_Size	Returns the number of bytes to be allocated if you call <code>mcGetProperty</code> with the parameter <code>mcPropDB_Filename</code> .
u32	mcPropDTOID	Returns the DTO CAN Identifier (D ata T ransfer O bject) for CCP or XCP on CAN which is used to send commands and data from the slave device to the host.
u32	mcPropECU_BaudRate	Returns the baud rate in use.
u32	mcPropECU_ByteOrder	Returns the byte order of the slave device. 0— MSB_LAST The Slave device uses the MSB_LAST (Intel) byte ordering. 1— MSB_FIRST The Slave device uses the MSB_FIRST (Motorola) byte ordering.
str	mcPropECU_Checksum	Returns the file name of the Checksum DLL used for verifying the checksum.
u32	mcPropECU_Checksum_Size	Returns the number of bytes to be allocated if you call <code>mcGetProperty</code> with the parameter <code>mcPropECU_Checksum</code> .
u32	mcPropECU_CmdByteOrder	Returns the byte order for multi-byte command parameters. 0— MSB_LAST The CCP Slave device uses the MSB_LAST (Intel) byte ordering. 1— MSB_FIRST The CCP Slave device uses the MSB_FIRST (Motorola) byte ordering.
u32	mcPropECU_CRO_ID	Returns the CRO ID (C ommand R eceive O bject) which is used to send commands and data from the host to the slave device.

Table 6-4. Values for PropertyID (Continued)

Data Type	Name	Description
nctType Taskref	mcPropECU_CRO_Task	NI-CAN Task reference to the CAN Task assigned to the CRO ID.
u32	mcPropECU_DTO_ID	Returns the DTO ID (Data Transmission Object) which is used by the ECU to respond to CCP commands and send data and status information to the CCP master.
nctType Taskref	mcPropECU_DTO_Task	NI-CAN Task reference to the CAN Task assigned to the DTO ID.
[u8]	mcPropECU_ID	Returns the slave device identifier. This ID information is optional and specific to the ECU implementation. For more information about the CCP slave ID information refer to the documentation for the ECU.
u8	mcPropECU_ID_DataType	Returns a data type qualifier of the slave device ID information. This ID information is optional and specific to the ECU implementation. For more information about the CCP slave ID information refer to the documentation for the ECU.
u8	mcPropECU_ID_Length	Returns the length of the slave device identifier in bytes.
u32	mcPropECU_Interface	Returns the interface initialized for the task, such as with <code>mcDAQInitialize</code> .
[u8]	mcPropECU_MasterID	Returns CCP master ID information. This ID information is optional and specific to the ECU implementation. For more information about the CCP master ID information refer to the documentation for the ECU.
str	mcPropECU_Name	Returns the name of the selected ECU opened by <code>mcECUSelectEx</code> .
[u16]	mcPropECU_DAQList Numbers	Returns an array of DAQ list numbers for all DAQ lists defined in the A2L file.

Table 6-4. Values for PropertyID (Continued)

Data Type	Name	Description
u32	mcPropECU_TimingFactor	Returns the used timing factor, which you can use to increase CCP or XCP command timeout values. For details on the default Command Timeout values, refer to the CCP or XCP Protocol Specification.
u16	mcPropDAQList_MaxLength	Returns the maximum length of the DAQ list.
u32	mcPropDAQList_CANIdSelectMode	Returns how to select the CAN ID for the specified DAQ list: 0—CAN_ID_FIXED The CAN Identifier is a predefined fixed number. 1—CAN_ID_VARIABLE The CAN Identifier is a variable number. 2—CAN_ID_DTO_ID The CAN Identifier is the same as the DTO identifier.
u32	mcPropDAQList_CANId	Returns the CAN ID for the specified DAQ list if mcPropDAQList_CANIdSelectMode == CAN_ID_FIXED.
u8	mcPropDAQList_FirstPID	Returns the first Packet ID for the specified DAQ list.
u32	mcPropDAQList_NumberOfEventChannels	Returns the number of allowed event channels for the specified DAQ list.
[u8]	mcPropDAQList_EventChannels	Returns an array of event channel numbers referenced by the DAQ list.
u32	mcPropDAQList_ReductionAllowed	Returns whether or not the specified DAQ list allows reduction.
u32	mcPropDAQList_NumberOfExcludedDAQLists	Returns the length of the array containing the numbers of DAQ lists not working together with the current DAQ list.

Table 6-4. Values for PropertyID (Continued)

Data Type	Name	Description
u16	mcPropDAQList_Excluded DAQLists	Returns an array containing the numbers of DAQ lists not working together with the current DAQ list.
u32	mcPropECU_Name_Size	Returns the number of bytes to be allocated if you call mcGetProperty with the parameter mcPropECU_Name.
str	mcPropECU_SeedKey_Cal	Returns the file name of the SeedKey DLL used for Calibration purposes.
u32	mcPropECU_SeedKey_Cal_ Size	Returns the number of bytes to be allocated if you call mcGetProperty with the parameter mcPropECU_SeedKey_Cal.
str	mcPropECU_SeedKey_DAQ	Returns the file name of the SeedKey DLL used for DAQ purposes.
u32	mcPropECU_SeedKey_DAQ_ Size	Returns the number of bytes to be allocated if you call mcGetProperty with the parameter mcPropECU_SeedKey_DAQ.
str	mcPropECU_SeedKey_Prog	Returns the file name of the SeedKey DLL used for programming purposes.
u32	mcPropECU_SeedKey_ Prog_Size	Returns the number of bytes to be allocated if you call mcGetProperty with the parameter mcPropECU_SeedKey_Prog.
str	mcPropECU_SeedKey_XCP	Returns the file name of the SeedKey DLL for XCP.
u32	mcPropECU_SeedKey_XCP_ Size	Returns the number of bytes to be allocated if you call mcGetProperty with the parameter mcPropECU_SeedKey_XCP.
u8	mcPropECU_Single_Byte_ DAQ_Lists	Determines if an ECU supports single-byte or multi-byte DAQ list entries.

Table 6-4. Values for PropertyID (Continued)

Data Type	Name	Description
u32	mcPropECU_Station Address	Returns the station address of the slave device. CCP is based on the idea that several ECUs can share the same CAN Arbitration IDs for CCP communication. To avoid communication conflicts, CCP defines a Station Address that must be unique for all ECUs sharing the same CAN Arbitration IDs. Unless an ECU has been addressed by its Station Address, the ECU must not react to CCP commands sent by the CCP master.
u32	mcPropGen_Version_ Build	Returns the build number of the ECU M&C software. This number applies to Development, Alpha, and Beta phase only, and should be ignored for Release phase.
str	mcPropGen_Version_ Comment	Returns a comment string for the ECU M&C software. If you received a custom release of ECU M&C from National Instruments, this comment often describes special features of the release.
u32	mcPropGen_Version_ Comment_Size	Returns the number of bytes to be allocated if you call mcGetProperty with the parameter <code>mcPropGen_Version_Comment</code> .
u32	mcPropGen_Version_ Major	Returns the major version of the ECU M&C software, such as the 1 in version 1.2.5.
u32	mcPropGen_Version_ Minor	Returns the minor version of the ECU M&C software, such as the 2 in version 1.2.5.
u32	mcPropGen_Version_ Update	Returns the update version of the ECU M&C software, such as the 5 in version 1.2.5.
str	mcPropIPAddress	Returns the IP address for XCP on Ethernet (TCP or UDP) as a string.
u32	mcPropIPAddress_Size	Returns the number of bytes to be allocated if you call mcGetProperty with the parameter <code>mcPropIPAddress</code> .
u16	mcPropIPPort	Returns the IP port for XCP on Ethernet (TCP or UDP).

Table 6-4. Values for PropertyID (Continued)

Data Type	Name	Description
u32	mcPropMeas_Address	Returns the address of the selected Measurement in the memory of the control unit.
u32	mcPropMeas_ByteOrder	Returns the specified byte order: 0—Intel format Bytes are in little-endian order, with least-significant bit first. 1—Motorola format Bytes are in big-endian order, with most-significant bit first.
u8	mcPropMeas_Datatype	Returns the data type of the Measurement task.
u8	mcPropMeas_Extension	Returns the address extension of the ECU address. This optional parameter may contain additional address information defined in the A2L database. For instance it can be used, to distinguish different address spaces of an ECU (multi-microcontroller devices).
u32	mcPropMeas_IsVirtual	Returns whether the Measurement is virtual. Virtual Measurements are not transmitted by the ECU but are calculated in the application. They return an error when opened in a DAQ list.
f64	mcPropMeas_Maximum	Returns the maximum value of the Measurement.
f64	mcPropMeas_Minimum	Returns the minimum value of the Measurement.
u32	mcPropMeas_ReadOnly	Returns <code>TRUE</code> if the selected Measurement is read only and can only be accessed through <code>mcMeasurementRead</code> , or returns <code>FALSE</code> if the Measurement can be accessed through <code>mcMeasurementWrite</code> as well.
str	mcPropMeas_Unit	Returns the unit string defined for this Measurement in the A2L database.

Table 6-4. Values for PropertyID (Continued)

Data Type	Name	Description
u32	mcPropMeas_Unit_Size	Returns the number of bytes to be allocated if you call <code>mcGetProperty</code> with the parameter <code>mcPropMeas_Unit</code> .
u32	mcPropOptCmd_ACTION_SERVICE	Returns whether the ECU supports the optional CCP Command ACTION_SERVICE.
u32	mcPropOptCmd_BUILD_CHKSUM	Returns whether the ECU supports the optional CCP Command BUILD_CHKSUM.
u32	mcPropOptCmd_CLEAR_MEMORY	Returns whether the ECU supports the optional CCP Command CLEAR_MEMORY.
u32	mcPropOptCmd_DIAG_SERVICE	Returns whether the ECU supports the optional CCP Command DIAG_SERVICE.
u32	mcPropOptCmd_DNLOAD_6	Returns whether the ECU supports the optional CCP Command DNLOAD_6.
u32	mcPropOptCmd_GET_ACTIVE_CAL_PAGE	Returns whether the ECU supports the optional CCP Command GET_ACTIVE_CAL_PAGE.
u32	mcPropOptCmd_GET_S_STATUS	Returns whether the ECU supports the optional CCP Command GET_S_STATUS.
u32	mcPropOptCmd_GET_SEED	Returns whether the ECU supports the optional CCP Command GET_SEED.
u32	mcPropOptCmd_MOVE	Returns whether the ECU supports the optional CCP Command MOVE.
u32	mcPropOptCmd_PROGRAM	Returns whether the ECU supports the optional CCP Command PROGRAM.
u32	mcPropOptCmd_PROGRAM_6	Returns whether the ECU supports the optional CCP Command PROGRAM_6.
u32	mcPropOptCmd_SELECT_CAL_PAGE	Returns whether the ECU supports the optional CCP Command SELECT_CAL_PAGE.
u32	mcPropOptCmd_SET_S_STATUS	Returns whether the ECU supports the optional CCP Command SET_S_STATUS.
u32	mcPropOptCmd_SHORT_UP	Returns whether the ECU supports the optional CCP Command SHORT_UP.

Table 6-4. Values for PropertyID (Continued)

Data Type	Name	Description
u32	mcPropOptCmd_START_STOP_ALL	Returns whether the ECU supports the optional CCP Command START_STOP_ALL.
u32	mcPropOptCmd_TEST	Returns whether the ECU supports the optional CCP Command TEST.
u32	mcPropOptCmd_UNLOCK	Returns whether the ECU supports the optional CCP Command UNLOCK.
u8	mcPropPGM_AccessMethod	Returns the selected access mode for mcProgram and mcClearMemory: 0x00— Absolute Access Mode (default). The MTA uses physical addresses 0x01— Functional Access Mode . The MTA functions as a block sequence number of the new flash content file. 0x80...0xFF— User defined . It is possible to use different access modes for clearing and programming.
u8	mcPropPGM_Compression Method	Returns the selected compression method used for mcProgram. 0—Data is uncompressed (default). 0x80...0xFF—User defined.
u8	mcPropPGM_Encryption Method	Returns the selected encryption method used for mcProgram. 0—Data is not encrypted (default). 0x80...0xFF—User defined.
u8	mcPropPGM_Programming Method	Returns the selected programming method used for mcProgram. 0—Sequential programming (default). 0x80...0xFF—User defined.

mcMeasurementCreate

Purpose

Creates a Measurement object in memory.

Format

```
mcTypeStatus      mcMeasurementCreate(
                    mcTypeTaskRef  ECUREfNum,
                    char *MeasurementName,
                    mcAddress  Address,
                    i32  DataType,
                    u8  DataSize,
                    char *ConversionName);
```

Input

ECUREfNum ECUREfNum is the task reference which links to the selected ECU. This reference is originally returned from `mcECUCreate`.

Address Configures the target address for the programming operation in the ECU. `mcAddress` is a C struct consisting of:

Address

Specifies the address part of the programming address.

Extension

Extension contains the extension part of the address.

DataType `DataType` sets the data type of the measurement task.

DataType	Data Format
0	Unsigned byte
1	Signed byte
2	Unsigned word
3	Signed word
4	Unsigned long
5	Signed long
6	Float 32

<code>DataSize</code>	Sets the size of the measurement data and corresponds to the selected <code>DataType</code> .																
	<table> <thead> <tr> <th>Data Format</th> <th>DataSize</th> </tr> </thead> <tbody> <tr> <td>Unsigned byte</td> <td>1</td> </tr> <tr> <td>Signed byte</td> <td>1</td> </tr> <tr> <td>Unsigned word</td> <td>2</td> </tr> <tr> <td>Signed word</td> <td>2</td> </tr> <tr> <td>Unsigned long</td> <td>4</td> </tr> <tr> <td>Signed long</td> <td>4</td> </tr> <tr> <td>Float 32</td> <td>4</td> </tr> </tbody> </table>	Data Format	DataSize	Unsigned byte	1	Signed byte	1	Unsigned word	2	Signed word	2	Unsigned long	4	Signed long	4	Float 32	4
Data Format	DataSize																
Unsigned byte	1																
Signed byte	1																
Unsigned word	2																
Signed word	2																
Unsigned long	4																
Signed long	4																
Float 32	4																
<code>ConversionName</code>	<code>ConversionName</code> identifies the referred conversion object that <code>mcConversionCreate</code> defines.																

Output

Return Value

The return value indicates the status of the function call as a signed 32-bit integer. Zero means the function executed successfully. A negative value specifies an error, which means the function did not perform the expected behavior. A positive value specifies a warning, which means the function performed as expected, but a condition arose that may require attention.

Use the `mcStatusToString` function of the ECU M&C API to obtain a descriptive string for the return value.

Description

Use `mcMeasurementCreate` to create a measurement object in memory instead of referring to a predefined measurement in the A2L database.

mcMeasurementRead

Purpose

Reads a single Measurement value from the ECU.

Format

```
mcTypeStatus      mcMeasurementRead(
                    mcTypeTaskRef ECURefNum,
                    char *MeasurementName,
                    f64 *Value);
```

Input

ECURefNum	ECURefNum is the task reference which links to the selected ECU. This reference is originally returned from mcECUSelectEx .
MeasurementName	MeasurementName is the name of a Measurement channel stored in the A2L database file from which a Measurement value is to be read.

Output

Value	Returns a single sample for the Measurement channel initialized in MeasurementName.
-------	---

Return Value

The return value indicates the status of the function call as a signed 32-bit integer. Zero means the function executed successfully. A negative value specifies an error, which means the function did not perform the expected behavior. A positive value specifies a warning, which means the function performed as expected, but a condition arose that may require attention.

Use the [mcStatusToString](#) function of the ECU M&C API to obtain a descriptive string for the return value.

Description

`mcMeasurementRead` performs a single point read (upload) of a single Measurement from the selected ECU without opening a Measurement task.

mcMeasurementWrite

Purpose

Writes a single Measurement value to the ECU.

Format

```
mcTypeStatus      mcMeasurementWrite(
                    mcTypeTaskRef ECURefNum,
                    char *MeasurementName,
                    f64 Values);
```

Input

ECURefNum	ECURefNum is the task reference which links to the selected ECU. This reference is originally returned from <code>mcECUSelectEx</code> .
MeasurementName	MeasurementName is the name of a Measurement channel stored in the A2L database file to which a Measurement value is to be written.
Values	Writes a single sample for the Measurement channel initialized in MeasurementName.

Output

Return Value

The return value indicates the status of the function call as a signed 32-bit integer. Zero means the function executed successfully. A negative value specifies an error, which means the function did not perform the expected behavior. A positive value specifies a warning, which means the function performed as expected, but a condition arose that may require attention.

Use the `mcStatusToString` function of the ECU M&C API to obtain a descriptive string for the return value.

Description

`mcMeasurementWrite` performs a single point write (download) of a Measurement into the selected ECU without opening a Measurement task. `mcMeasurementWrite` can only be performed if the Measurement channel is not set to read only. To query if an ECU Measurement channel can be accessed by `mcMeasurementWrite`, call `mcGetProperty` with the parameter `mcPropMeas_ReadOnly`.

mcProgram

Purpose

Programs a memory block on the ECU.

Format

```
mcTypeStatus      mcProgram(
                    mcTypeTaskRef ECURefNum,
                    mcAddress Address,
                    u32 BlockSize,
                    u8 *Data);
```

Input

ECURefNum	ECURefNum is the task reference which links to the selected ECU. This reference is originally returned from mcECUSelectEx .
Address	Configures the target address for the programming operation in the ECU. <code>mcAddress</code> is a C struct consisting of: <p>Address Specifies the address part of the programming address.</p> <p>Extension Extension contains the extension part of the address.</p>
BlockSize	BlockSize determines the size of the data block which is transferred to the ECU and used for programming from the MTA0 target.
Data	data contains the byte array that is transmitted to the ECU.

Output

Return Value

The return value indicates the status of the function call as a signed 32-bit integer. Zero means the function executed successfully. A negative value specifies an error, which means the function did not perform the expected behavior. A positive value specifies a warning, which means the function performed as expected, but a condition arose that may require attention.

Use the [mcStatusToString](#) function of the ECU M&C API to obtain a descriptive string for the return value.

Description

If you are using the CCP protocol, `mcProgram` implements the CCP command PROGRAM. The command is used to program the specified data into non-volatile ECU memory (Flash, EEPROM, etc.). Programming starts at the selected MTA0 address and extension defined in the `Address` struct. The `mcProgram` function auto-increments the ECU MTA0 address.

If you are using the XCP protocol, `mcProgram` implements the XCP command PROGRAM. The command is used to program a non-volatile memory segment inside the ECU slave. Depending on the access mode (defined by `PROGRAM_FORMAT`), two different concepts are supported. The end of the memory segment is indicated when `BlockSize` is set to 0. The end of the overall programming sequence is indicated by using the `mcProgramReset` command which executes the XCP command `PROGRAM_RESET`, causing the slave device to move into a disconnected state. Usually a hardware reset of the slave device is executed. This command may support block transfer similar to the commands `DOWNLOAD` and `DOWNLOAD_NEXT`. For further information on how to use `mcProgram` and details on block mode transfers refer to the *ASAM XCP Part 2 Protocol Layer Specification*.

mcProgramReset

Purpose

Indicates the end of a programming sequence.

Format

```
mcTypeStatus          mcProgramReset (
                        mcTypeTaskRef ECURefNum);
```

Input

ECURefNum ECURefNum is the task reference which links to the selected ECU. This reference is originally returned from [mcECUSelectEx](#).

Output

Return Value

The return value indicates the status of the function call as a signed 32-bit integer. Zero means the function executed successfully. A negative value specifies an error, which means the function did not perform the expected behavior. A positive value specifies a warning, which means the function performed as expected, but a condition arose that may require attention.

Use the [mcStatusToString](#) function of the ECU M&C API to obtain a descriptive string for the return value.

Description

If you are using the XCP protocol, [mcSetProperty](#) implements the XCP command PROGRAM_RESET. This optional command indicates the end of a non-volatile memory programming sequence and may or may not have a response from the ECU. In either case, the slave device will go into a disconnected state.

[mcSetProperty](#) may be used to reset a slave device for other purposes. For further information on how to use program ECU memory and to use the [mcSetProperty](#) command refer to the *ASAM XCP Part 2 Protocol Layer Specification*.

mcProgramStart

Purpose

Indicates the start of a programming sequence.

Format

```
mcTypeStatus          mcProgramStart (
                        mcTypeTaskRef ECURefNum) ;
```

Input

ECURefNum ECURefNum is the task reference which links to the selected ECU. This reference is originally returned from [mcECUSelectEx](#).

Output

Return Value

The return value indicates the status of the function call as a signed 32-bit integer. Zero means the function executed successfully. A negative value specifies an error, which means the function did not perform the expected behavior. A positive value specifies a warning, which means the function performed as expected, but a condition arose that may require attention.

Use the [mcStatusToString](#) function of the ECU M&C API to obtain a descriptive string for the return value.

Description

If you are using the XCP protocol, `mcProgramStart` implements the XCP command `PROGRAM_START`. This optional command the beginning of a programming sequence into a non-volatile memory area. If the slave device is not in a state which permits programming, an error is returned. The memory programming commands The end of a non-volatile memory programming sequence is indicated by using the [mc SetProperty](#) function.

For further information on how to use program ECU memory and to use the `mcProgramStart` command refer to the *ASAM XCP Part 2 Protocol Layer Specification*.

mcSetProperty

Purpose

Sets a property of the driver, the database, the ECU, a Characteristic, a Measurement, or a Measurement task.

Format

```
mcTypeStatus      mcSetProperty(
                    mcTypeTaskRef RefNum,
                    cstr Name,
                    u32 PropertyID,
                    u32 SizeOfValue,
                    void *Value);
```

Input

RefNum	RefNum is any ECU M&C task reference which consists of a valid link to the opened A2L database (DBRefNum), a selected ECU (ECURefNum) or a Measurement task (DAQRefNum). RefNum must be valid for the related PropertyID type.
Name	Name is not used and can be set to NULL. This parameter maybe used for further extensions.
PropertyID	Selects the property to set. For a description of each property, including its data type and PropertyId, refer to the <i>Properties</i> section.
SizeOfValue	Number of bytes allocated for the Value output. This size normally depends on the data type listed in the description of the property.
Value	Provides the property value. PropertyId determines the data type of the value.

Output

Return Value

The return value indicates the status of the function call as a signed 32-bit integer. Zero means the function executed successfully. A negative value specifies an error, which means the function did not perform the expected behavior. A positive value specifies a warning, which means the function performed as expected, but a condition arose that may require attention.

Use the [mcStatusToString](#) function of the ECU M&C API to obtain a descriptive string for the return value.

Description

There are four types of properties which can be modified in the poly input value: ECU-specific properties, DAQ-specific properties, Characteristic-specific properties, and Measurement-specific properties.

ECU-Specific Properties

You cannot set an ECU property while the application is connected to the ECU. If you need to change a ECU property prior to connecting, call `mcECUSelectEx`, followed by `mcSetProperty`, and then `mcECUConnect`. After you connect to the ECU, you also can change a property by calling `mcECUDisconnect`, followed by `mcSetProperty`, and then `mcECUConnect` to restart the task. Table 6-5 contains a listing of ECU-specific values for `PropertyID`.

DAQ-Specific Properties

You cannot set a DAQ property while a Measurement task is running. If you need to change a property prior to starting a Measurement task call `mcDAQInitialize`, followed by `mcSetProperty`, and then `mcDAQStartStop`. After you start the Measurement task, you also can change a property by calling `mcDAQStartStop`, followed by `mcSetProperty`, and then `mcDAQStartStop` to restart the task. Table 6-6 contains a listing of ECU-specific values for `PropertyID`.

Properties

Table 6-5. ECU-Specific Value Types for the `PropertyID` Input Value

Data Type	Name	Description
u32	<code>mcPropCANBaudRate</code>	Sets the CAN Baud rate for CCP or XCP on CAN which is used to send commands and data from the host to the slave device.
u32	<code>mcPropCmd_EXCHANGE_ID</code>	Sets whether or not the <code>EXCHANGE_ID</code> command should be suppressed during connection to the ECU.
u32	<code>mcPropCROID</code>	Sets the CRO CAN Identifier (C ommand R eceive O bject) for CCP or XCP on CAN which is used to send commands and data from the host to the slave device.
u32	<code>mcPropDTOID</code>	Sets the DTO CAN Identifier (D ata T ransfer O bject) for CCP or XCP on CAN which is used to send commands and data from the slave device to the host.

Table 6-5. ECU-Specific Value Types for the PropertyID Input Value (Continued)

Data Type	Name	Description
u32	mcPropECU_BaudRate	<p>Sets the Baud rate in use by the selected interface. This property applies to all tasks initialized with the NI-CAN or NI-XNET interface. You can specify the following basic baud rates as the numeric rate: 33333, 83333, 100000, 125000, 200000, 250000, 400000, 500000, 800000, and 1000000. You can specify advanced baud rates as 8000XXYY hex, where YY is the value of Bit Timing Register 0 (BTR0), and XX is the value of Bit Timing Register 1 (BTR1).</p> <p>For more information, refer to the Interface Properties dialog in MAX. The value of this property is originally set within MAX, but it can be changed using mc SetProperty.</p>
u32	mcPropECU_ByteOrder	<p>Sets the Byte Order of the slave device.</p> <p>0—MSB_LAST</p> <p>The Slave device uses the MSB_LAST (Intel) byte ordering.</p> <p>1—MSB_FIRST</p> <p>The Slave device uses the MSB_FIRST (Motorola) byte ordering.</p>
str	mcPropECU_Checksum	<p>Sets the file name of the Checksum DLL used for verifying the checksum.</p>
u32	mcPropECU_CmdByteOrder	<p>Sets the byte order for multi-byte command parameters.</p> <p>0—MSB_LAST</p> <p>The CCP Slave device uses the MSB_LAST (Intel) byte ordering.</p> <p>1—MSB_FIRST</p> <p>The CCP Slave device uses the MSB_FIRST (Motorola) byte ordering.</p>

Table 6-5. ECU-Specific Value Types for the PropertyID Input Value (Continued)

Data Type	Name	Description
u32	mcPropECU_CRO_ID	Sets the CAN identifier for the CRO ID (C ommand R eceive O bject), which is used to send commands and data from the host to the slave device.
u32	mcPropECU_DTO_ID	Sets the DTO ID (D ata T ransmission O bject) which is used by the ECU to respond to CCP commands and send data and status information to the CCP master.
u32	mcPropECU_MasterID	Sets CCP master ID information. This ID information is optional and specific to the ECU implementation. For more information about the CCP master ID information refer to the documentation for the ECU.
str	mcPropECU_SeedKey_Cal	Sets the file name of the SeedKey DLL used for Calibration purposes.
str	mcPropECU_SeedKey_DAQ	Sets the file name of the SeedKey DLL used for DAQ purposes.
str	mcPropECU_SeedKey_Prog	Sets the file name of the SeedKey DLL used for programming purposes.
str	mcPropECU_SeedKey_XCP	Sets the file name of the SeedKey DLL for XCP.
u8	mcPropECU_Single_Byte_DAQ_Lists	Sets the ECU to support single-byte or multi-byte DAQ list entries.
u32	mcPropECU_Station Address	Sets the station address of the slave device. CCP is based on the idea that several ECUs can share the same CAN Arbitration IDs for CCP communication. To avoid communication conflicts, CCP defines a Station Address that must be unique for all ECUs sharing the same CAN Arbitration IDs. Unless an ECU has been addressed by its Station Address, the ECU must not react to CCP commands sent by the CCP master.

Table 6-5. ECU-Specific Value Types for the PropertyID Input Value (Continued)

Data Type	Name	Description
u32	mcPropECU_TimingFactor	Sets the timing factor, which you can use to increase CCP or XCP command timeout values. For details on the default Command Timeout values, refer to the CCP or XCP Protocol Specification.
str	mcPropIPAddress	Sets the IP address for XCP on Ethernet (TCP or UDP) as a string.
u16	mcPropIPPort	Sets the IP port for XCP on Ethernet (TCP or UDP).
u32	mcPropOptCmd_ACTION_SERVICE	Sets whether the ECU supports the optional CCP Command ACTION_SERVICE.
u32	mcPropOptCmd_BUILD_CHKSUM	Sets whether the ECU supports the optional CCP Command BUILD_CHKSUM.
u32	mcPropOptCmd_CLEAR_MEMORY	Sets whether the ECU supports the optional CCP Command CLEAR_MEMORY.
u32	mcPropOptCmd_DIAG_SERVICE	Sets whether the ECU supports the optional CCP Command DIAG_SERVICE.
u32	mcPropOptCmd_DNLOAD_6	Sets whether the ECU supports the optional CCP Command DNLOAD_6.
u32	mcPropOptCmd_GET_ACTIVE_CAL_PAGE	Sets whether the ECU supports the optional CCP Command GET_ACTIVE_CAL_PAGE.
u32	mcPropOptCmd_GET_S_STATUS	Sets whether the ECU supports the optional CCP Command GET_S_STATUS.
u32	mcPropOptCmd_GET_SEED	Sets whether the ECU supports the optional CCP Command GET_SEED.
u32	mcPropOptCmd_MOVE	Sets whether the ECU supports the optional CCP Command MOVE.
u32	mcPropOptCmd_PROGRAM	Sets whether the ECU supports the optional CCP Command PROGRAM.
u32	mcPropOptCmd_PROGRAM_6	Sets whether the ECU supports the optional CCP Command PROGRAM_6.

Table 6-5. ECU-Specific Value Types for the PropertyID Input Value (Continued)

Data Type	Name	Description
u32	mcPropOptCmd_SELECT_CAL_PAGE	Sets whether the ECU supports the optional CCP Command SELECT_CAL_PAGE.
u32	mcPropOptCmd_SET_S_STATUS	Sets whether the ECU supports the optional CCP Command SET_S_STATUS.
u32	mcPropOptCmd_SHORT_UP	Sets whether the ECU supports the optional CCP Command SHORT_UP.
u32	mcPropOptCmd_START_STOP_ALL	Sets whether the ECU supports the optional CCP Command START_STOP_ALL.
u32	mcPropOptCmd_TEST	Sets whether the ECU supports the optional CCP Command TEST.
u32	mcPropOptCmd_UNLOCK	Sets whether the ECU supports the optional CCP Command UNLOCK.
u8	mcPropPGM_AccessMethod	<p>Selects the selected access mode for mcProgram and mcClearMemory:</p> <p>0x00—Absolute Access Mode (default). The MTA uses physical addresses.</p> <p>0x01—Functional Access Mode. The MTA functions as a block sequence number of the new flash content file.</p> <p>0x80...0xFF—User defined. It is possible to use different access modes for clearing and programming.</p>
u8	mcPropPGM_Compression Method	<p>Selects the selected compression method used for mcProgram.</p> <p>0—Data is uncompressed (default).</p> <p>0x80...0xFF—User defined.</p>

Table 6-5. ECU-Specific Value Types for the PropertyID Input Value (Continued)

Data Type	Name	Description
u8	mcPropPGM_Encryption Method	Selects the selected encryption method used for mcProgram . 0—Data is not encrypted (default). 0x80...0xFF—User defined.
u8	mcPropPGM_Programming Method	Selects the selected programming method used for mcProgram . 0—Sequential programming (default). 0x80...0xFF—User defined.

Table 6-6. DAQ-Specific Value Types for the PropertyID Input Value

Data Type	Name	Description
u32	mcPropDAQ_DTO_ID	Sets the DTO ID (Data Transmission Object) which is used by the ECU to respond to send data from the DAQ lists to the CCP master.
abc	mcPropDAQ_EventChannelName	Sets the selected event channel name to which the Measurement task is assigned.
i32	mcPropDAQ_Mode	<p>Sets the mode of an M&C Measurement task.</p> <p>0—DAQ List</p> <p>The data is transmitted from the ECU in equidistant time intervals as defined in the A2L database. The data can be read back with <code>mcDAQRead</code> as Single point data using sample rate = 0, or as waveform using a sample rate > 0. Input channel data is received from the DAQ messages. Use <code>mcDAQRead</code> to obtain input samples as single-point, array, or waveform.</p> <p>1—Polling</p> <p>In this mode the data from the Measurement task is uploaded from the ECU whenever <code>mcDAQRead</code> is called.</p>
u16	mcPropDAQ_Prescaler	Sets the Prescaler, which reduces the desired transmission frequency of the associated DAQ list.

Characteristic-Specific Properties

Table 6-7. Characteristic-Specific Value Types for the PropertyID Input Value

Data Type	Name	Description
double[]	mcPropChar_X_Axis	Sets the X-axis values on which the Characteristic is defined. The Characteristic dimension must be at least 1.

Table 6-7. Characteristic-Specific Value Types for the PropertyID Input Value (Continued)

Data Type	Name	Description
double[]	mcPropChar_Y_Axis	Sets the Y-axis values on which the Characteristic is defined. The Characteristic dimension must be 2.
u32	mcPropChar_ByteOrder	Sets the specified byte order of the selected Characteristic: 0— Intel format Bytes are in little-endian order, with least-significant bit first. 1— Motorola format Bytes are in big-endian order, with most-significant bit first.

Measurement-Specific Properties

Table 6-8. Measurement-Specific Value Types for the PropertyID Input Value

Data Type	Name	Description
u32	mcPropMeas_ByteOrder	Sets the specified byte order of the selected Measurement: 0— Intel format Bytes are in little-endian order, with least-significant bit first. 1— Motorola format Bytes are in big-endian order, with most-significant bit first.

mcStatusToString

Purpose

Converts a status code into a descriptive string.

Format

```
mcTypeStatus      mcStatusToString(
                    mcTypeTaskRef Status,
                    u32 SizeOfString,
                    str ErrorString);
```

Input

Status Nonzero status code returned from an ECU M&C function.
SizeOfString SizeOfString buffer (in bytes).

Output

ErrorString ASCII string that describes Status.

Description

When the status code returned from an ECU M&C function is nonzero, an error or warning is indicated. This function is used to obtain a description of the error/warning for debugging purposes.

The return code is passed into the `Status` parameter. The `SizeOfString` parameter indicates the number of bytes available in the string for the description. The description is truncated to size `SizeOfString` if needed, but a size of 300 characters is large enough to hold any description. The text returned in `ErrorString` is null-terminated, so it can be used with ANSI C functions such as `printf`. For applications written in C or C++, each ECU M&C function returns a status code as a signed 32-bit integer. The following table summarizes the ECU M&C use of this status.

Table 6-9. Description of Return Codes

Status Code	Definition
Negative	Error—Function did not perform expected behavior.
Positive	Warning—Function performed as expected, but a condition arose that may require attention.
Zero	Success—Function completed successfully.

The application code should check the status returned from every ECU M&C function. If an error is detected, you should close all ECU M&C handles and exit the application. If a warning is detected, you can display a message for debugging purposes or simply ignore the warning.

The following piece of code shows an example of handling ECU M&C status during application debugging.

```
status= ncDatabaseOpen ("TestDataBase.A2L", &MyDbHandle);
PrintStat (status, "mcOpenDatabase");
```

where the function `PrintStat` has been defined at the top of the program as:

```
void PrintStat(mcTypeStatus status, char *source)
{
    char statusString[300];
    if(status !=0)
    {
        mcStatusToString(status, sizeof(statusString), statusString);
        printf("\n%s\nSource = %s\n", statusString, source);
        if (status < 0)
        {
            mcDatabaseClose(MyDbHandle);

            exit(1);
        }
    }
}
```

In some situations, you may want to check for specific errors in the code. For example, when `mcCharacteristicRead` times out, you may want to continue communication, rather than exit the application. To check for specific errors, use the constants defined in `niemc.h`. These constants have the same names as described in this manual. For example, to check for a function timeout, use:

```
if (status == mcErrorTimeout)
    ...
```

mcUpload

Purpose

Uploads data from an ECU.

Format

```
mcTypeStatus      mcUpload(
                    mcTypeTaskRef ECURefNum,
                    mcAddress Address,
                    u32 BlockSize,
                    u8 *Data);
```

Input

ECURefNum	ECURefNum is the task reference which links to the selected ECU. This reference is originally returned from mcECUSelectEx .
Address	Configures the source address for the upload operation in the ECU. mcAddress is a C struct consisting of: <p>Address Specifies the address part of the source address.</p> <p>Extension Extension contains the extension part of the address.</p>
BlockSize	BlockSize is the size of the data block in bytes to be uploaded.

Output

Data	Data is a byte array which receives the uploaded data information from the ECU.
------	---

Return Value

The return value indicates the status of the function call as a signed 32-bit integer. Zero means the function executed successfully. A negative value specifies an error, which means the function did not perform the expected behavior. A positive value specifies a warning, which means the function performed as expected, but a condition arose that may require attention.

Use the [mcStatusToString](#) function of the ECU M&C API to obtain a descriptive string for the return value.

Description

If you are using the CCP protocol, `mcUpload` implements the CCP command UPLOAD. A data block of the specified length starting at the specified address is uploaded from the ECU. This function sets the Memory Transfer Address pointer MTA0 to the appropriate value as defined in the `Address` struct.

If you are using the XCP protocol, `mcUpload` implements the XCP command UPLOAD. A data block of the specified length starting at the specified address is uploaded from the ECU. The Memory Transfer Address pointer MTA0 is post-incremented by the given number of data elements. If the slave device does not support block transfer mode, all uploaded data is transferred in a single response packet. If block transfer mode is supported, the uploaded data is transferred in multiple responses on the same request packet. There are no limitations allowed concerning the maximum block size for the master.

Refer to the *ASAM XCP Part 2 Protocol Layer Specification* for more information on how to upload data and to use the `mcUpload` command.

mcXCPCopyCalPage

Purpose

Forces a copy transaction of one calibration page to another.

Format

```
mcTypeStatus      mcXCPCopyCalPage (
                    mcTypeTaskRef ECURefNum,
                    u8 SourceSegment,
                    u8 SourcePage,
                    u8 DestinationSegment,
                    u8 DestinationPage);
```

Input

ECURefNum	ECURefNum is the task reference which links to the selected ECU. This reference is originally returned from mcECUSelectEx .
SourceSegment	SourceSegment specifies the logical data segment number source.
SourcePage	SourcePage specifies the logical page number source.
DestinationSegment	DestinationSegment specifies the logical data segment number destination.
DestinationPage	DestinationPage specifies the logical page number destination.

Output

None.

Return Value

The return value indicates the status of the function call as a signed 32-bit integer. Zero means the function executed successfully. A negative value specifies an error, which means the function did not perform the expected behavior. A positive value specifies a warning, which means the function performed as expected, but a condition arose that may require attention.

Use the [mcStatusToString](#) function of the ECU M&C API to obtain a descriptive string for the return value.

Description

[mcXCPCopyCalPage](#) implements the XCP command COPY_CAL_PAGE and forces the slave to copy one calibration page to another. This command is only available if more than one calibration page is defined. In principal, any page of any segment can be copied to any page of any other segment but there may be restrictions.

Refer to the ASAM *XCP Part 2 Protocol Layer Specification* for more information on how to set up a request.

mcXCPGetCalPage

Purpose

Queries a calibration page setting.

Format

```
mcTypeStatus      mcXCPGetCalPage (
                    mcTypeTaskRef  ECURefNum,
                    u8  Mode,
                    u8  Segment,
                    u8  *Page);
```

Input

ECURefNum	ECURefNum is the task reference which links to the selected ECU. This reference is originally returned from mcECUSelectEx .
Mode	Mode specifies the access mode: Mode = 1 The given page is used by the slave device application. Mode = 2 The slave device XCP driver will access the given page.
Segment	Segment specifies the selected logical data segment number.

Output

Page	Page returns the logical data page number.
------	--

Return Value

The return value indicates the status of the function call as a signed 32-bit integer. Zero means the function executed successfully. A negative value specifies an error, which means the function did not perform the expected behavior. A positive value specifies a warning, which means the function performed as expected, but a condition arose that may require attention.

Use the [mcStatusToString](#) function of the ECU M&C API to obtain a descriptive string for the return value.

Description

`mcXCPGetCalPage` implements the XCP command `GET_CAL_PAGE` and queries the logical number for the calibration data page that is currently activated for the specified access mode and data segment.

Refer to the *ASAM XCP Part 2 Protocol Layer Specification* for more information on how to set up a request.

mcXCPGetID

Purpose

Queries session configuration or slave device identification.

Format

```
mcTypeStatus      mcXCPGetID(
                    mcTypeTaskRef ECURefNum,
                    u8 Type,
                    u32 *Length,
                    char *Id);
```

Input

ECURefNum ECURefNum is the task reference which links to the selected ECU. This reference is originally returned from [mcECUSelectEx](#).

Type Type specifies the type of the requested identification:

Type	Description
0	ASCII text
1	ASAM-MC2 filename without path and extension
2	ASAM-MC2 filename with path and extension
3	URL where the ASAM-MC2 file can be found
4	ASAM-MC2 file to upload 128..255 User defined

Output

Length Length returns the string length of the Id string.

Id Id contains the queried identification string.

Return Value

The return value indicates the status of the function call as a signed 32-bit integer. Zero means the function executed successfully. A negative value specifies an error, which means the function did not perform the expected behavior. A positive value specifies a warning, which means the function performed as expected, but a condition arose that may require attention.

Use the `mcStatusToString` function of the ECU M&C API to obtain a descriptive string for the return value.

Description

`mcXCPGetID` implements the XCP command GET_ID and returns session configuration or slave device identification information of the selected ECU slave device. The supported types are implementation specific of the ECU slave device. The identification string is ASCII text format.

mcXCPGetStatus

Purpose

Queries the current session status from an ECU slave device.

Format

```
mcTypeStatus      mcXCPGetStatus (
                    mcTypeTaskRef ECURefNum,
                    u8 *SessionStatus,
                    u8 *ResourceMask,
                    u16 *SessionId);
```

Input

ECURefNum ECURefNum is the task reference which links to the selected ECU. This reference is originally returned from [mcECUSelectEx](#).

Output

SessionStatus SessionStatus returns the current status of the selected ECU.
ResourceMask ResourceMask is the current resource protection status of the selected ECU.
SessionId SessionId returns the defined session configuration ID.

Return Value

The return value indicates the status of the function call as a signed 32-bit integer. Zero means the function executed successfully. A negative value specifies an error, which means the function did not perform the expected behavior. A positive value specifies a warning, which means the function performed as expected, but a condition arose that may require attention.

Use the [mcStatusToString](#) function of the ECU M&C API to obtain a descriptive string for the return value.

Description

`mcXCPGetStatus` implements the XCP command GET_STATUS and returns all current status information of the selected ECU slave device, including the status of the resource protection, pending store requests and the general status of data acquisition and stimulation.

Current Session Status

SessionStatus contains a bit mask which is described below:

Bit Number	Flag	Description
0	STORE_CAL_REQ	REQuest to STORE CALibration data: 0—STORE_CAL_REQ mode is reset. 1—STORE_CAL_REQ mode is set.
1	Unused	—
2	STORE_DAQ_REQ	REQuest to STORE DAQ list: 0—STORE_DAQ_REQ mode is reset. 1—STORE_DAQ_REQ mode is set.
3	CLEAR_DAQ_REQ	REQuest to CLEAR DAQ configuration: 0—CLEAR_DAQ_REQ is reset. 1—CLEAR_DAQ_REQ is set.
4	Unused	—
5	Unused	—
6	DAQ_RUNNING	Data Transfer: 0—The data transfer is not running. 1—The data transfer is running.
7	RESUME	RESUME Mode: 0—The slave device is not in RESUME mode. 1—The slave device is in RESUME mode.

The STORE_CAL_REQ flag indicates a pending request to save the calibration data into non-volatile memory. As soon as the request has been fulfilled, the slave will reset the appropriate bit. The slave device may indicate this by transmitting an EV_STORE_CAL event packet.

The STORE_DAQ_REQ flag indicates a pending request to save the DAQ list setup in non-volatile memory. As soon as the request has been fulfilled, the slave will reset the appropriate bit. The slave device may indicate this by transmitting an EV_STORE_DAQ event packet.

The CLEAR_DAQ_REQ flag indicates a pending request to clear all DAQ lists in non-volatile memory. All ODT entries are reset to address = 0, extension = 0, size = 0 and bit_offset = FF. Session configuration ID is reset to 0. As soon as the request has been fulfilled, the slave will reset the appropriate bit. The slave device may indicate this by transmitting an EV_CLEAR_DAQ event packet. If the slave device does not support the requested mode, an ERR_OUT_OF_RANGE is returned.

The DAQ_RUNNING flag indicates that at least one DAQ list has been started and is in RUNNING mode.

The RESUME flag indicates that the slave is in RESUME mode.

ResourceMask contains the current resource protection status as a bit mask described below:

Bit Number	Flag	Description
0	CAL/PAG	REQuest to STORE CALibration data: 0—STORE_CAL_REQ mode is reset. 1—STORE_CAL_REQ mode is set.
1	Unused	—
2	DAQ	DAQ list commands (DIRECTION = DAQ): 0—DAQ list commands are not protected with SEED & Key mechanism. 1—DAQ list commands are protected with SEED & Key mechanism.
3	STIM	DAQ list commands (DIRECTION = STIM): 0—DAQ list commands are not protected with SEED & Key mechanism. 1—DAQ list commands are protected with SEED & Key mechanism.
4	PGM	ProGraMming commands: 0—ProGraMming commands are not protected with SEED & Key mechanism. 1—ProGraMming commands are protected with SEED & Key mechanism
5	Unused	—

Bit Number	Flag	Description
6	Unused	—
7	Unused	—

The CAL/PAG flags indicates that all commands of the CALibration/PAGing group are protected and will return an `ERR_ACCESS_LOCKED` upon an attempt to execute the command without a previous successful `GET_SEED/UNLOCK` sequence.

The PGM flags indicates that all the commands of the ProGraMming group are protected and will return a `ERR_ACCESS_LOCKED` upon an attempt to execute the command without a previous successful `GET_SEED/UNLOCK` sequence.

The parameter `sessionId` contains the Session configuration ID. The session configuration ID must be set by a prior `mcXCPSetRequest` call with `STORE_DAQ_REQ` set. This allows the master device to verify that automatically started DAQ lists contain the expected data transfer configuration.

mcXCProgramPrepare

Purpose

Prepares the programming of non volatile memory.

Format

```
mcTypeStatus      mcXCProgramPrepare (
                    mcTypeTaskRef ECURefNum,
                    mcAddress Address,
                    u16 CodeSize);
```

Input

ECURefNum ECURefNum is the task reference which links to the selected ECU. This reference is originally returned from [mcECUSelectEx](#).

Address Address is the task reference which links to the selected ECU. This reference is originally returned from [mcECUSelectEx](#).

Address

Specifies the address part of the target address.

Extension

Contains the extension part of the target address.

CodeSize CodeSize determines the size of data to be downloaded.

Output

Return Value

The return value indicates the status of the function call as a signed 32-bit integer. Zero means the function executed successfully. A negative value specifies an error, which means the function did not perform the expected behavior. A positive value specifies a warning, which means the function performed as expected, but a condition arose that may require attention.

Use the [mcStatusToString](#) function of the ECU M&C API to obtain a descriptive string for the return value.

Description

`mcXCProgramPrepare` may be used to indicate a data download as a pre-condition for non-volatile memory reprogramming. The Memory Transfer address (MTA) pointer is set to the volatile memory location specified by the parameters Address and Extension. The download itself is done by using subsequent standard commands like [mcDownload](#). The slave device must ensure that the target memory area is available and it is in an operational state which permits the download of code. If not, an error will be returned.

[mcXCProgramPrepare](#) implements the optional XCP PROGRAM_PREPARE command defined by the XCP specification. For further information on how to program non-volatile ECU memory refer to the *ASAM XCP Part 2 Protocol Layer Specification*.

mcXCPProgramVerify

Purpose

Verifies the programming of non-volatile ECU memory.

Format

```
mcTypeStatus      mcXCPProgramVerify(
                    mcTypeTaskRef  ECURefNum,
                    u8  Mode,
                    u16 VerType,
                    u32 VerValue);
```

Input

ECURefNum ECURefNum is the task reference which links to the selected ECU. This reference is originally returned from [mcECUSelectEx](#).

Mode Mode describes the verification mode:

Value	Description
0	Request to start internal routine.
1	Send a Verification Value stored in VerValue.

VerType VerType specifies the Verification Type of the requested program verification. The Verification Type is a bit mask described below:

Verification Type	Description
0x0001	Calibration area(s) of the flash.
0x0002	Code area(s) of the flash.
0x0004	Complete flash content.
0x0008 ... 0x0080	Reserved.
0x0100 ... 0xFF00	User defined.

VerValue VerValue contains the selected verification value if Mode=1.

Output

None.

Return Value

The return value indicates the status of the function call as a signed 32-bit integer. Zero means the function executed successfully. A negative value specifies an error, which means the function did not perform the expected behavior. A positive value specifies a warning, which means the function performed as expected, but a condition arose that may require attention.

Use the `mcStatusToString` function of the ECU M&C API to obtain a descriptive string for the return value.

Description

`mcXCPProgramVerify` implements the XCP command PROGRAM_VERIFY and performs a flash program verification. If `VerMode = 0` the master can request the slave to start internal test routines to check whether the new flash contents fits to the rest of the flash. Only the result is of interest. If `VerMode = 01`, the master can tell the slave that he is sending a Verification Value to the slave. The definition of the Verification Mode is project specific. The master is getting the Verification Mode from the project specific programming flow control and passing it to the slave. The tool needs no further information about the details of the project specific check routines. The XCP parameters allow a wide range of project specific adaptations. The Verification Type is specified in the project specific programming flow control. The master is getting this parameter and passing it to the slave. The definition of the Verification Value is project specific and the use is defined in the project specific programming flow control.

Refer to the *ASAM XCP Part 2 Protocol Layer Specification* for more information on how to set up a request.

`mcXCPProgramVerify` can be used to verify the success of non-volatile memory reprogramming.

With `Mode` set to 00 the master can request the slave to start internal test routines to check whether the new flash contents fits to the rest of the flash. Only the result is of interest. With `Mode` set to 01, the master can tell the slave that he will be sending a Verification value to the slave. The definition of the Verification mode is project-specific. The master receives the Verification mode from the project-specific programming flow control and passes it to the slave.

`mcXCPProgramVerify` implements the optional XCP PROGRAM_VERIFY command defined by the XCP specification. For further information on how to program non-volatile ECU memory refer to the *ASAM XCP Part 2 Protocol Layer Specification*.

mcXCPSetCalPage

Purpose

Sets a calibration page.

Format

```
mcTypeStatus      mcXCPSetCalPage (
                    mcTypeTaskRef  ECURefNum,
                    u8  Mode,
                    u8  Segment,
                    u8  Page);
```

Input

ECURefNum ECURefNum is the task reference which links to the selected ECU. This reference is originally returned from [mcECUSelectEx](#).

Mode Mode is a bit mask described below:

Bit	Description
0	The given page is used by the slave device application.
1	The slave device XCP driver will access the given page.
2	Unused.
3	Unused.
4	Unused.
5	Unused.
6	Unused.
7	The logical segment number is ignored. The command applies to all segments.

Segment Segment specifies the selected logical data segment number.

Page Page specifies the logical data page number.

Output

None.

Return Value

The return value indicates the status of the function call as a signed 32-bit integer. Zero means the function executed successfully. A negative value specifies an error, which means the function did not perform the expected behavior. A positive value specifies a warning, which means the function performed as expected, but a condition arose that may require attention.

Use the `mcStatusToString` function of the ECU M&C API to obtain a descriptive string for the return value.

Description

`mcXCPSetCalPage` implements the XCP command `SET_CAL_PAGE` and sets the access mode for a calibration data segment, if the slave device supports calibration data page switching. A calibration data segment and its pages are specified by logical numbers.

Refer to the *ASAM XCP Part 2 Protocol Layer Specification* for more information on how to set up a request.

mcXCPSetRequest

Purpose

Performs a request to save session and device information to non-volatile memory.

Format

```
mcTypeStatus          mcXCPSetRequest (
                        mcTypeTaskRef  ECURefNum,
                        u8  Mode,
                        u16 SessionID);
```

Input

ECURefNum ECURefNum is the task reference which links to the selected ECU. This reference is originally returned from `mcECUSelectEx`.

Mode Mode is a bit mask described below:

Bit	Description
0	Request to store calibration data in non-volatile memory.
1	Unused.
2	Request to save all DAQ lists, which have been selected with START_STOP_DAQ_LIST(Select) into non-volatile memory. The slave also must store the session configuration ID in non-volatile memory. Upon saving, the slave first must clear any DAQ list configuration that might already be stored in non-volatile memory.
3	Request to clear all DAQ lists in non-volatile memory. All ODT entries reset to address = 0, extension = 0, size = 0 and bit_offset = FF. Session configuration ID reset to 0.
4	Unused.
5	Unused.
6	Unused.
7	Unused.

SessionID SessionID is a session configuration ID that is stored in non-volatile memory together with the information requested by the Mode parameter.

Output

None.

Return Value

The return value indicates the status of the function call as a signed 32-bit integer. Zero means the function executed successfully. A negative value specifies an error, which means the function did not perform the expected behavior. A positive value specifies a warning, which means the function performed as expected, but a condition arose that may require attention.

Use the [mcStatusToString](#) function of the ECU M&C API to obtain a descriptive string for the return value.

Description

[mcXCPSetRequest](#) implements the XCP command SET_REQUEST and is used to save session configuration information into non-volatile memory in the ECU.

Refer to the *ASAM XCP Part 2 Protocol Layer Specification* for more information on how to setup a request.

mcXCPSetSegmentMode

Purpose

Sets the mode of a specified segment.

Format

```
mcTypeStatus      mcXCPSetSegmentMode (
                    mcTypeTaskRef  ECURefNum,
                    u8  Segment,
                    u8  Mode) ;
```

Input

ECURefNum	ECURefNum is the task reference which links to the selected ECU. This reference is originally returned from mcECUSelectEx .
Segment	Segment specifies the logical data segment number.
Mode	Mode specifies the mode for the segment.

Output

None.

Return Value

The return value indicates the status of the function call as a signed 32-bit integer. Zero means the function executed successfully. A negative value specifies an error, which means the function did not perform the expected behavior. A positive value specifies a warning, which means the function performed as expected, but a condition arose that may require attention.

Use the [mcStatusToString](#) function of the ECU M&C API to obtain a descriptive string for the return value.

Description

`mcXCPSetSegmentMode` implements the XCP command `SET_SEGMENT_MODE` and sets the selected segment into the specified mode. If `Mode = 0` the segment disables the FREEZE mode, if `Mode = 1` the segment is set to FREEZE mode through an XCP `STORE_CAL_REQ` operation.

Refer to the *ASAM XCP Part 2 Protocol Layer Specification* for more information on how to set up a request.

Summary of the CCP Standard

Controller Area Network (CAN)

Bosch developed the Controller Area Network (CAN) in the mid-1980s. Using CAN, devices (controllers, sensors, and actuators) are connected on a common serial bus. This network of devices can be thought of as a scaled-down, real-time, low-cost version of the networks used to connect personal computers. Any device on a CAN network can communicate with any other device using a common pair of wires.

As CAN implementations increased in the automotive industry, CAN was standardized internationally as ISO 11898. CAN chips were created by major semiconductor manufacturers such as Intel, Motorola, and Philips. With these developments, manufacturers of industrial automation equipment began to consider CAN for use in industrial applications. Comparison of the requirements for automotive and industrial device networks showed numerous similarities, including the transition away from dedicated signal lines, low cost, resistance to harsh environments, and high real-time capabilities.

CAN Calibration Protocol (CCP)

The amount of electronics introduced into the automobile has increased significantly. This trend is expected to continue as automobile manufacturers initiate further advances in safety, reliability and comfort. The introduction of advanced control systems—combining multiple sensors, actuators and electronic control units—has begun to place extensive demands on the existing Controller Area Network (CAN) communication bus. To enable the new generation of automotive electronics, new and highly sophisticated software, calibration, measurement, and diagnostic equipment must be used. At this time almost no standards exist in the area of software interfaces for such devices. Each company has its proprietary systems and interfaces to support the development of these high-end configurations.

The CAN Calibration Protocol was originally developed and introduced by Ingenieurbüro Helmut Kleinknecht, a manufacturer of calibration systems, and is used in various application areas in the automotive industry. Afterwards CCP was taken over by the ASAP working group and enhanced with optional functions and is now maintained by the ASAM organization.

Scope of CCP

The CAN Calibration Protocol is a CAN-based master-slave protocol for calibration and data acquisition using the CAN 2.0B standard (11-bit and 29-bit identifiers), which includes 2.0A (11-bit identifier). A single master device (host) can be connected to one or more slave devices. Before a slave device may accept commands from the host, the host must establish a logical point-to-point connection to the slave device. After this connection has been established, the slave device must acknowledge each command received from the host within a specific time.

CCP offers continuous or event driven data acquisition from the controllers, as well as memory transfers to and control functions in the controllers for calibration purposes.

With these functions, CCP may be used in:

- The development of electronic control units (ECU)
- Systems for functional and environmental tests of an ECU
- Test systems and test stands for controlled devices (combustion engines, gearboxes, suspension systems, climate-control systems, body systems, anti-locking systems)
- On-board test and measurement systems of pre-series vehicles
- Any non-automotive application of CAN-based distributed electronic control systems

CCP defines two function sets—one for control/memory transfer, and one for data acquisitions that are independent of each other and may run asynchronously. The control commands are used to carry out functions in the slave device, and may use the slave to perform tasks on other devices. The data acquisition commands are used for continuous data acquisition from a slave device. The devices continuously transmit internal data according to a list that has been configured by the host. Data acquisition is initiated by the host, then executed by the slave device, and may be based on a fixed sampling rate or be event-driven.

CCP Protocol Definition

Two communication objects are defined by CCP to handle the communication between host and slave devices—The **CommandReceiveObject (CRO)**, which is used to send commands and data from the host to the slave device; and the **DataTransmissionObject (DTO)**, which is used to transmit handshake messages, data and status information from the slave device to the host. Each of these message objects is assigned a unique CAN ID. Messages that are returned from the slave as a message to a command are called **CommandReturnMessages (CRM)**.

A Command Receive Object is a CAN message consisting of eight bytes. The first byte of a CRO is the **command** code, followed by the **command counter** byte. The command counter is generated for reference by the host to make sure that the CRM returned by a slave device corresponds to the correct host command. The rest of the message builds the parameter and data fields. The structure is as follows:

0	1	2	3	4	5	6	7
CMD	CTR	Parameter and Data Field					

A DataTransmissionObject has a **PacketID (PID)** as the first byte. This PID determines how the rest of the message is interpreted. CCP differentiates between three types of DTOs:

PID	Type
0x00—0xFD	Data Acquisition Message
0xFE	Event Message
0xFF	Command Return Message

Command Return Messages and Event Messages have the following structure:

0	1	2	3	4	5	6	7
PID	ERR	Parameter and Data Field					

In the case of an Event Message, the **Counter** field does not contain valid data and must be ignored by the host. For Command Return Messages the Counter field must have the same value as the counter field of the corresponding CRO. The error field contains information about the error state. The **parameter** and **data** fields contain the data returned from the slave device to the host. Command Return Messages and Event Messages consist of eight bytes.

Data Acquisition Messages (DAQ Messages or DAMs) have a PID in the first byte, and the rest of the message contains data. DAMs may be shorter than eight bytes:

0	1	2	3	4	5	6	7
PID	Parameter and Data Field						

Since the PIDs 0x00—0xFD are reserved for Data Acquisition Messages, a CCP slave device can send up to 253 different DAMs. Each DAQ message can transfer up to seven bytes of data. The number of DAQ Messages supported by a slave device depends on the device itself.

Data acquisition is performed through a CCP slave device by reading data from a device's memory and copying it into the data field of a DAQ message. So the CCP slave device keeps a list of entries for each DAM. These lists are called **ObjectDefinitionTables (ODTs)**. Each ODT entry holds information about the memory address where data is stored inside the device and the size of the data to be sent. The data of the first ODT entry is placed in the first byte of the data field of the DAQ message. The data of the next entry is placed at the first free byte of the DAQ message, and so on.

Technical Support and Professional Services

Visit the following sections of the award-winning National Instruments Web site at ni.com for technical support and professional services:

- **Support**—Technical support at ni.com/support includes the following resources:
 - **Self-Help Technical Resources**—For answers and solutions, visit ni.com/support for software drivers and updates, a searchable KnowledgeBase, product manuals, step-by-step troubleshooting wizards, thousands of example programs, tutorials, application notes, instrument drivers, and so on. Registered users also receive access to the NI Discussion Forums at ni.com/forums. NI Applications Engineers make sure every question submitted online receives an answer.
 - **Standard Service Program Membership**—This program entitles members to direct access to NI Applications Engineers via phone and email for one-to-one technical support as well as exclusive access to on demand training modules via the Services Resource Center. NI offers complementary membership for a full year after purchase, after which you may renew to continue your benefits.

For information about other technical support options in your area, visit ni.com/services, or contact your local office at ni.com/contact.

- **Training and Certification**—Visit ni.com/training for self-paced training, eLearning virtual classrooms, interactive CDs, and Certification program information. You also can register for instructor-led, hands-on courses at locations around the world.
- **System Integration**—If you have time constraints, limited in-house technical resources, or other project challenges, National Instruments Alliance Partner members can help. To learn more, call your local NI office or visit ni.com/alliance.

If you searched ni.com and could not find the answers you need, contact your local office or NI corporate headquarters. Phone numbers for our worldwide offices are listed at the front of this manual. You also can visit the Worldwide Offices section of ni.com/niglobal to access the branch office Web sites, which provide up-to-date contact information, support phone numbers, email addresses, and current events.

Glossary

Symbol	Prefix	Value
m	milli	10^{-3}
k	kilo	10^3
M	mega	10^6

Numbers

2MC (* .A2L) database file *See* ASAM MCD 2MC.

A

A2L file ECU device database file in ASAM MCD 2MC format.

address extension An additional parameter to the address that may be used to switch between data of several memory banks.

API Application Program Interface—A set of routines, protocols, and tools for building software applications.

arbitration ID An 11- or 29-bit ID transmitted as the first field of a CAN frame. The arbitration ID determines the priority of the frame, and is normally used to identify the data transmitted in the frame.

ASAM Association of Standardization of Automation and Measurement Systems.

ASAM MCD 2MC ASAM MCD 2MC is a file interface standardized by ASAM which describes the internal ECU data, interfaces, and communication protocols. It contains all information about relevant data objects in the ECU like Characteristic variables (parameters, characteristic curves, and maps), real/virtual measurement variables, and variant dependencies. For each of these objects information is needed, such as storage address, record layout, data type, and conversion rules to convert the data into their physical units.

B

- baudrate A user-defined property which provides the baud rate at which communication will occur. For more information, refer to the **Interface Properties** dialog in MAX, or the *NI-CAN Hardware and Software Manual*. The baud rate is originally set within MAX.
- byte order The *byte order* refers to which bytes are most significant in multi-byte data types. The term describes the order in which a sequence of bytes is stored in computer memory.

C

- calibration data page A portion of the ECU memory containing data that controls the behavior of the ECU.
- CAN Controller Area Network. The Controller Area Network (CAN) is a joint development of Robert Bosch GmbH and Intel Corporation. CAN is used in many high-end automotive control systems, like engine management, as well as in industrial control systems. Controller chips for CAN are available from various semiconductor manufacturers.
- CCP CAN Calibration Protocol.
- CCP master The CCP master device (host) is a calibration/monitoring tool for initiating data transfers on the CAN by sending commands to slave devices.
- CCP slave Typically an ECU which communicates through CCP with the CCP master.
- Characteristic A Characteristic is a memory area within the ECU which defines the behavior of a control subsystem. Calibration is a process to optimize the Characteristic. A Characteristic can be represented by a single value (parameter), a one-dimensional array of values (curve), or a two-dimensional array of values (map).
- Checksum DLL A Dynamic Link Library which implements a function to calculate a checksum over a given data block.
- Command Receive Object (CRO) A Command Receive Object (CRO) is sent from the CCP master device to one of the slave devices. The slave device answers with a Data Transmission Object (DTO) containing a Command Return Message (CRM).

Controller Area Network *See* [CAN](#).

CRM Command Return Message—A CCP communication object used to send commands and data from a host device to a slave device. The CRO is 8 bytes wide, consisting of a Command byte, a Command Counter byte, and a 6-byte parameter/data field.

CRO CommandReceiveObject—A CCP communication object used to send commands and data from a host device to a slave device. The CRO is 8 bytes wide, consisting of a Command byte, a Command Counter byte, and a 6-byte parameter/data field.

CRO ID CAN identifier of the Command Receive Object (CRO)

D

DAQ Data Acquisition.

DAQ channel A single DAQ Measurement entry in a DAQ list.

DAQ list A list of DAQ channels that is transmitted by the ECU.

DAQ mode Data acquisition mode.

Data Transfer Object A message sent from the slave device to the master device (Command Return Message, Event Message, or Data Acquisition Message).

database task A task reference handle to the selected ASAM MCD 2MC database file.

DLL Dynamic Link Library.

DTO *See* Data Transfer Object.

DTO ID CAN identifier of the DTO.

E

ECU	Electronic Control Unit—An electronic device with a central processing unit performing programmed functions with its peripheral circuitry.
ECU M&C Channel functions	<p>The part of the ECU M&C Toolkit API that you use to read and write channels.</p> <p>A Characteristic or Measurement channel consists of one more floating-point values in physical units (such as Volts, rpm, km/h, °C, and so on) that is converted to/from a raw value in measurement hardware. The ECU M&C API Read and Write functions provide access to Characteristic or Measurement channels. When a CAN message is received, ECU M&C Toolkit converts raw fields in the message into physical units, which you then obtain using the ECU M&C API Read function. When you call a ECU M&C API Write function, you provide floating-point values in physical units, which ECU M&C Toolkit converts into raw fields and transmits as a CAN message based on the CCP protocol.</p>
ECU reference	Reference handle to a selected ECU.
ECU task	<i>See</i> ECU reference.
Event Channel	Specifies the generic signal source that effectively determines the data transmission timing.
Extended arbitration ID	A 29-bit arbitration ID. Frames that use extended IDs are often referred to as CAN 2.0 Part B (the specification which defines them).

M

Master ID	A 6-byte string identifying the CCP master device.
Measurement	<i>See</i> DAQ .
Measurement task	A collection of DAQ channels that you can read or write.
Memory Transfer Address	Address pointer in the ECU that holds the source/target address for data sent or received via CCP. The address extension depends on the slave controller's organization and may identify a switchable memory bank or a memory segment.
MTA	<i>See</i> Memory Transfer Address.

O

ODT Object Descriptor Table—A list of elements (variables) used for organization of data acquisition (DAQ).

P

PID **PacketID**—The first byte of a DTO corresponding to the ODT to which the DTO is assigned. The values for DAQ list PIDs range from 0x00–0xFD. The PIDs 0xFE and 0xFF are reserved for Event Messages and Command Return Messages.

Prescaler A factor defined to allow reduction of the desired transmission rate. The prescaler is applied to the Event Channel. The prescaler value factor must be greater than or equal to 1.

S

SeedKey DLL A Dynamic Link Library that implements a function to calculate a key to a given seed to unlock access to ECU resources.

slave device identifier An ECU-specific array of bytes used by the master device to identify the ECU.

Station Address A property which specifies an address to generate a logical point-to-point connection with a selected slave station for the master-slave command protocol. One ECU may support several station addresses.

T

task reference An identifier returned as an output parameter of Database, ECU or Measurement initialization functions.

Index

A

- accessing Characteristics, 4-7
- activating the ECU toolkit
 - home computer use, 2-4
 - moving software after installation, 2-4
 - online activation, 2-4
 - privacy policy, 2-4
 - procedure, 2-2
 - terms defined, 2-3
 - volume licensing, 2-4
- additional programming topics, 4-16
 - generic CCP functions, 4-17
 - generic XCP functions, 4-18
 - Get Names, 4-16
 - seed and key algorithm, 4-19
 - Set/Get Properties, 4-16
- application development
 - on CompactRIO or R Series, 3-4
- ASAM definition, 1-1
- ASAM MCD 2MC
 - communication properties
 - Baudrate, 4-6
 - CRO ID, 4-5
 - DTO ID, 4-5
 - Station Address, 4-5
 - with CAN, 4-5
 - with UDP or TCP, 4-6
 - overview, 1-1

B

- basic programming model, 4-3
 - Characteristic Read and Write, 4-7
 - communication (figure), 4-4
 - ECU Close, 4-7
 - ECU Connect, 4-6
 - ECU Disconnect, 4-7

- ECU Open, 4-5
- Measurement tasks, 4-9

Baudrate (property), 4-6

C

- C functions
 - list of functions, 6-2
 - mcBuildChecksum, 6-6
 - mcCalculateChecksum, 6-10
 - mcCCPActionService, 6-12
 - mcCCPDiagService, 6-14
 - mcCCPGetActiveCalPage, 6-16
 - mcCCPGetResult, 6-17
 - mcCCPGetSessionStatus, 6-18
 - mcCCPGetVersion, 6-19
 - mcCCPMoveMemory, 6-20
 - mcCCPSelectCalPage, 6-22
 - mcCCPSetSessionStatus, 6-23
 - options (table), 6-23
 - mcCharacteristicRead, 6-25
 - mcCharacteristicReadSingleValue, 6-26
 - mcCharacteristicWrite, 6-28
 - mcCharacteristicWriteSingleValue, 6-29
 - mcClearMemory, 6-31
 - mcConversionCreate, 6-32
 - mcDAQClear, 6-34
 - mcDAQInitialize, 6-35
 - mcDAQListInitialize, 6-38
 - mcDAQRead, 6-40
 - mcDAQReadTimestamped, 6-43
 - mcDAQStartStop, 6-46
 - mcDAQWrite, 6-48
 - mcDatabaseClose, 6-50
 - mcDatabaseOpen, 6-51
 - mcDownload, 6-52
 - mcECUConnect, 6-54

- mcECUCreate, 6-55
 - mcECUDeselect, 6-58
 - mcECUDisconnect, 6-59
 - mcECUSelectEx, 6-60
 - mcEventCreate, 6-63
 - mcGeneric, 6-64
 - mcGetNames, 6-66
 - mcGetNamesLength, 6-68
 - mcGetProperty, 6-70
 - options (table), 6-71
 - mcMeasurementCreate, 6-82
 - mcMeasurementRead, 6-84
 - mcMeasurementWrite, 6-85
 - mcProgram, 6-86
 - mcProgramReset, 6-88
 - mcProgramStart, 6-89
 - mcSetProperty, 6-90
 - Characteristic-specific options (table), 6-97
 - DAQ-specific options (table), 6-97
 - ECU-specific options (table), 6-91
 - Measurement-specific options (table), 6-98
 - mcStatusToString, 6-99
 - return codes (table), 6-99
 - mcUpload, 6-101
 - mcXCPCopyCalPage, 6-103
 - mcXCPCGetCalPage, 6-105
 - mcXCPCGetID, 6-107
 - mcXCPCGetStatus, 6-109
 - mcXCPCProgramPrepare, 6-113
 - mcXCPCProgramVerify, 6-115
 - mcXCPCSetCalPage, 6-117
 - mcXCPCSetRequest, 6-119
 - mcXCPCSetSegmentMode, 6-121
 - CAN Bridge (FPGA) VI
 - customizing, 3-5
 - CAN calibration protocol (CCP)
 - overview, 1-2, A-1
 - version, 1-2
 - CAN overview, A-1
 - CCP
 - functions, 4-3
 - overview, A-1
 - protocol definition, A-3
 - scope, A-2
 - Channel functions, 4-2
 - Characteristic Read and Write, 4-7
 - Characteristics
 - accessing, 4-7
 - reading, 4-8
 - writing, 4-8
 - checksum algorithm, 4-21
 - definition, 4-21, 4-22
 - for VxWorks targets, 4-23
 - example, 4-23
 - choosing programming languages, 3-1
 - CompactRIO
 - application development, 3-4
 - conventions used in the manual, *xi*
 - CRO ID (property), 4-5
 - customizing CAN Bridge (FPGA) VI, 3-5
- ## D
- debugging an application, 3-5
 - definition of activation terms, 2-3
 - developing an application, 3-1
 - diagnostic tools (NI resources), B-1
 - documentation
 - conventions used in manual, *xi*
 - NI resources, B-1
 - related documentation, *xii*
 - drivers (NI resources), B-1
 - DTO ID (property), 4-5
- ## E
- ECU API
 - C, 6-1
 - LabVIEW, 5-1

- ECU Characteristics
 - definition, 4-2
 - overview, 1-4
- ECU Close, 4-7
- ECU Connect, 4-6
- ECU databases, 1-4
- ECU Disconnect, 4-7
- ECU M&C API
 - additional programming topics, 4-16
 - architecture (figure), 4-1
 - CCP functions overview, 4-3
 - Channel functions, 4-2
 - structure, 4-1
 - XCP functions overview, 4-3
- ECU Measurements
 - DAQ Clear, 4-13
 - DAQ Read, 4-11
 - DAQ Start Stop, 4-10
 - DAQ Write, 4-12
 - definition, 4-2
 - DTO ID, 4-10
 - ECU DAQ Initialize, 4-10
 - ECU reference handle, 4-10
 - flowchart (figure), 4-9
 - list, 4-10
 - mode, 4-10
 - overview, 4-9
 - sample rate, 4-10
- ECU Open, 4-5
- ECU toolkit
 - activation, 2-2
 - API overview, 4-1
 - basic programming model, 4-3
 - Characteristics, 1-4
 - databases
 - ASAM MCD 2MC, 1-4
 - ASAP, 1-4
 - definition, 1-1
 - hardware and software requirements, 2-10
 - installation, 2-1

- introduction, 1-1
- LabVIEW RT, 2-5
- license management, 2-1
- Measurements, 1-4
- examples (NI resources), B-1

F

- FPGA and host computer
 - transferring data between, 3-4
- FTP transfers (table), 2-6
- FTP with LabVIEW, 2-9
- FTP with LabVIEW RT graphical file transfer utility, 2-7
- FTP with web browsers, 2-7

G

- generic CCP functions, 4-17
- generic XCP functions, 4-18
- Get Names, 4-16

H

- help, technical support, B-1
- home software use, 2-4

I

- instrument drivers (NI resources), B-1

K

- KnowledgeBase, B-1

L

- LabVIEW
 - list of VIs, 5-1
 - MC Build Checksum.vi, 5-5
 - MC Calc Checksum.vi, 5-8

- MC CCP Action Service.vi, 5-11
- MC CCP Diag Service.vi, 5-13
- MC CCP Generic.vi, 5-88
- MC CCP Get Active Cal Page.vi, 5-15
- MC CCP Get Result.vi, 5-17
- MC CCP Get Session Status.vi, 5-19
- MC CCP Get Version.vi, 5-21
- MC CCP Move Memory.vi, 5-23
- MC CCP Select Cal Page.vi, 5-25
- MC CCP Set Session Status.vi, 5-27
 - options (table), 5-28
- MC Characteristic Read Single Value.vi, 5-31
- MC Characteristic Read.vi, 5-29
 - options (table), 5-30
- MC Characteristic Write Single Value.vi, 5-35
- MC Characteristic Write.vi, 5-33
 - options (table), 5-34
- MC Clear Memory.vi, 5-37
- MC Conversion Create.vi, 5-39
- MC DAQ Clear.vi, 5-41
- MC DAQ Initialize.vi, 5-43
- MC DAQ List Initialize.vi, 5-46
- MC DAQ Read.vi, 5-49
- MC DAQ Start Stop.vi, 5-55
- MC DAQ Write.vi, 5-57
- MC Database Close.vi, 5-60
- MC Database Open.vi, 5-62
- MC Download.vi, 5-64
- MC ECU Close.vi, 5-66
- MC ECU Connect.vi, 5-68
- MC ECU Create.vi, 5-70
- MC ECU Deselect.vi, 5-74
- MC ECU Disconnect.vi, 5-76
- MC ECU Open.vi, 5-78
- MC ECU Select.vi, 5-82
- MC Event Create.vi, 5-86
- MC Get Names.vi, 5-90
- MC Get Property.vi, 5-92
 - poly output values (table), 5-94
- MC Measurement Create.vi, 5-117
- MC Measurement Read.vi, 5-119
- MC Measurement Write.vi, 5-121
- MC Program Reset.vi, 5-125
- MC Program Start.vi, 5-127
- MC Program.vi, 5-123
- MC Set Property.vi, 5-129
 - Characteristic-specific input values (table), 5-141
 - DAQ-specific poly input values (table), 5-139
 - ECU-specific poly input values (table), 5-131
 - Measurement-specific input values (table), 5-141
- MC Upload.vi, 5-142
- MC XCP Copy Cal Page.vi, 5-144
- MC XCP Get Cal Page.vi, 5-146
- MC XCP Get ID.vi, 5-148
- MC XCP Get Status.vi, 5-150
- MC XCP Program Prepare.vi, 5-155
- MC XCP Program Verify.vi, 5-157
- MC XCP Set Cal Page.vi, 5-160
- MC XCP Set Request.vi, 5-162
- MC XCP Set Segment Mode.vi, 5-165
- LabVIEW Real-Time (RT) configuration, 2-5
 - CompactRIO system, 2-5
 - DOS prompt, 2-6
 - FTP transfers (table), 2-6
 - LabVIEW, 2-9
 - LabVIEW RT graphical file transfer utility, 2-7
 - NI-CAN on PXI RT system, 2-5
 - NI-XNET on PXI RT system, 2-5
 - PXI system, 2-5
 - web browsers, 2-7
- license management overview, 2-1
- list of C functions, 6-2
- list of LabVIEW VIs, 5-1

M

- MC Build Checksum.vi, 5-5
- MC Calc Checksum.vi, 5-8
- MC CCP Action Service.vi, 5-11
- MC CCP Diag Service.vi, 5-13
- MC CCP Generic.vi, 5-88
- MC CCP Get Active Cal Page.vi, 5-15
- MC CCP Get Result.vi, 5-17
- MC CCP Get Session Status.vi, 5-19
- MC CCP Get Version.vi, 5-21
- MC CCP Move Memory.vi, 5-23
- MC CCP Select Cal Page.vi, 5-25
- MC CCP Set Session Status.vi, 5-27
 - options (table), 5-28
- MC Characteristic Read Single Value.vi, 5-31
- MC Characteristic Read.vi, 5-29
 - options (table), 5-30
- MC Characteristic Write Single Value.vi, 5-35
- MC Characteristic Write.vi, 5-33
 - options (table), 5-34
- MC Clear Memory.vi, 5-37
- MC Conversion Create.vi, 5-39
- MC DAQ Clear.vi, 5-41
- MC DAQ Initialize.vi, 5-43
- MC DAQ List Initialize.vi, 5-46
- MC DAQ Read.vi, 5-49
- MC DAQ Start Stop.vi, 5-55
- MC DAQ Write.vi, 5-57
- MC Database Close.vi, 5-60
- MC Database Open.vi, 5-62
- MC Download.vi, 5-64
- MC ECU Close.vi, 5-66
- MC ECU Connect.vi, 5-68
- MC ECU Create.vi, 5-70
- MC ECU Deselect.vi, 5-74
- MC ECU Disconnect.vi, 5-76
- MC ECU Open.vi, 5-78
- MC ECU Select.vi, 5-82
- MC Event Create.vi, 5-86
- MC Get Names.vi, 5-90
- MC Get Property.vi, 5-92
 - poly output values (table), 5-94
- MC Measurement Create.vi, 5-117
- MC Measurement Read.vi, 5-119
- MC Measurement Write.vi, 5-121
- MC Program Reset.vi, 5-125
- MC Program Start.vi, 5-127
- MC Program.vi, 5-123
- MC Set Property.vi, 5-129
 - Characteristic-specific input values (table), 5-141
 - DAQ-specific poly input values (table), 5-139
 - ECU-specific poly input values (table), 5-131
 - Measurement-specific input values (table), 5-141
- MC Upload.vi, 5-142
- MC XCP Copy Cal Page.vi, 5-144
- MC XCP Get Cal Page.vi, 5-146
- MC XCP Get ID.vi, 5-148
- MC XCP Get Status.vi, 5-150
- MC XCP Program Prepare.vi, 5-155
- MC XCP Program Verify.vi, 5-157
- MC XCP Set Cal Page.vi, 5-160
- MC XCP Set Request.vi, 5-162
- MC XCP Set Segment Mode.vi, 5-165
- mcBuildChecksum, 6-6
- mcCCPActionService, 6-12
- mcCCPCalculateChecksum, 6-10
- mcCCPDiagService, 6-14
- mcCCPGetActiveCalPage, 6-16
- mcCCPGetResult, 6-17
- mcCCPGetSessionStatus, 6-18
- mcCCPGetVersion, 6-19
- mcCCPMoveMemory, 6-20
- mcCCPSelectCalPage, 6-22
- mcCCPSetSessionStatus, 6-23
 - options (table), 6-23
- mcCharacteristicRead, 6-25
- mcCharacteristicReadSingleValue, 6-26

mcCharacteristicWrite, 6-28
 mcCharacteristicWriteSingleValue, 6-29
 mcClearMemory, 6-31
 mcConversionCreate, 6-32
 mcDAQClear, 6-34
 mcDAQInitialize, 6-35
 mcDAQListInitialize, 6-38
 mcDAQRead, 6-40
 mcDAQReadTimestamped, 6-43
 mcDAQStartStop, 6-46
 mcDAQWrite, 6-48
 mcDatabaseClose, 6-50
 mcDatabaseOpen, 6-51
 mcDownload, 6-52
 mcECUConnect, 6-54
 mcECUCreate, 6-55
 mcECUDeselect, 6-58
 mcECUDisconnect, 6-59
 mcECUSelectEx, 6-60
 mcEventCreate, 6-63
 mcGeneric, 6-64
 mcGetNames, 6-66
 mcGetNamesLength, 6-68
 mcGetProperty, 6-70
 options (table), 6-71
 mcMeasurementCreate, 6-82
 mcMeasurementRead, 6-84
 mcMeasurementWrite, 6-85
 mcProgram, 6-86
 mcProgramReset, 6-88
 mcProgramStart, 6-89
 mcSetProperty, 6-90
 Characteristic-specific options
 (table), 6-97
 DAQ-specific options (table), 6-97
 ECU-specific options (table), 6-91
 Measurement-specific options
 (table), 6-98
 mcStatusToString, 6-99
 return codes (table), 6-99
 mcUpload, 6-101

mcXCPCopyCalPage, 6-103
 mcXCPGetCalPage, 6-105
 mcXCPGetID, 6-107
 mcXCPGetStatus, 6-109
 mcXCPPProgramPrepare, 6-113
 mcXCPPProgramVerify, 6-115
 mcXCPSetCalPage, 6-117
 mcXCPSetRequest, 6-119
 mcXCPSetSegmentMode, 6-121
 measurement and calibration databases, 1-4

N

National Instruments support and services, B-1

O

online software activation, 2-4

P

privacy policy, 2-4
 programming examples (NI resources), B-1
 programming languages
 LabVIEW, 3-1
 LabWindows/CVI, 3-1
 other, 3-3
 Visual C++, 3-2

R

R Series
 application development, 3-4
 reactivation on another system, 2-4
 reading Characteristics, 4-8
 related documentation, *xii*
 RT configuration
 DOS prompt, 2-6
 FTP transfers (table), 2-6
 LabVIEW, 2-9

LabVIEW RT graphical file transfer utility, 2-7
 web browsers, 2-7

S

sample rate greater than 0, 4-12
 read sample timing (figure), 4-12
 sample rate=0, 4-11
 read sample timing (figure), 4-11
 seed and key algorithm, 4-19
 definition, 4-19
 example, 4-20
 for VxWorks targets, 4-23
 example, 4-23
 Set/Get Properties, 4-16
 setting up an ECU Measurement
 DAQ Clear, 4-13
 DAQ Read, 4-11
 DAQ Start Stop, 4-10
 DAQ Write, 4-12
 DTO ID, 4-10
 ECU DAQ Initialize, 4-10
 ECU reference handle, 4-10
 flowchart (figure), 4-9
 list, 4-10
 mode, 4-10
 overview, 4-9
 sample rate, 4-10
 software (NI resources), B-1
 Station Address (property), 4-5
 structure of ECU M&C API, 4-1
 support, technical, B-1

T

task (concept), 1-4
 technical support, B-1
 training and certification (NI resources), B-1
 transferring data between FPGA and host computer, 3-4
 troubleshooting (NI resources), B-1

U

using with FTP, 2-6

V

volume licensing program, 2-4

W

Web resources, B-1
 writing Characteristics, 4-8

X

XCP, functions overview, 4-3