

COMPREHENSIVE SERVICES

We offer competitive repair and calibration services, as well as easily accessible documentation and free downloadable resources.

SELL YOUR SURPLUS

We buy new, used, decommissioned, and surplus parts from every NI series. We work out the best solution to suit your individual needs.

 Sell For Cash  Get Credit  Receive a Trade-In Deal

OBSOLETE NI HARDWARE IN STOCK & READY TO SHIP

We stock **New**, **New Surplus**, **Refurbished**, and **Reconditioned** NI Hardware.



Bridging the gap between the manufacturer and your legacy test system.

 1-800-915-6216

 www.apexwaves.com

 sales@apexwaves.com

All trademarks, brands, and brand names are the property of their respective owners.

Request a Quote

 **CLICK HERE**

PXIe-8108

PRODUCT FLYER

PXI Express Embedded Controllers

CONTENTS

[PXI Express Embedded Controllers](#)

[Detailed View of PXIe-8880 Embedded Controller](#)

[Key Features](#)

[Platform-Based Approach to Test and Measurement](#)

[PXI Instrumentation](#)

[Hardware Services](#)

PXI Express Embedded Controllers

PXIe-8880, PXIe-8861, PXIe-8840, and PXIe-8821



- Latest high-performance Intel processors
- Operating system: Windows 10, Windows 7 and LabVIEW Real-Time.
- Up to 24 GB/s system bandwidth
- Solid State drives, Thunderbolt™ 3, USB 3.0, Gigabit Ethernet, and other peripheral ports.
- OS, hardware drivers and applications factory installed and ready to use

Built for Automated Test and Measurement

The highest performance PXI Express embedded controllers provide class-leading performance in a compact embedded form factor for your PXI-based test, measurement, and control systems. Besides offering high CPU performance, these controllers provide high I/O throughput coupled with a rich set of peripheral I/O ports and up to 32 GB of RAM. NI PXI embedded controllers are specifically designed to meet the demanding requirements of test, measurement, and control systems. They are available with the latest processor options in a rugged form factor designed to operate in a wide temperature range and high shock and vibration environments.

Table 1. NI offers PXI Express Embedded Controllers with Intel processors ranging from Intel Xeon to Intel Core i3.

	PXIe-8880	PXIe-8861	PXIe-8840 Quad Core	PXIe-8840	PXIe-8821
Processor	Intel Xeon E5-2618L v3	Intel Xeon E3-1515MV5	Intel Core i7-5700EQ	Intel Core i5-4400E	Intel Core i3-4110E
Processor Cores	8	4	4	2	2
Processor Frequency	2.3 GHz (3.4 GHz Turbo)	2.8 GHz (3.7 GHz Turbo)	2.6 GHz (3.4 GHz Turbo)	2.7 GHz (3.3 GHz Turbo)	2.6 GHz
Standard Memory	8 GB	8 GB	4 GB	4 GB	2 GB
Maximum Memory	24 GB	32 GB	8 GB	8 GB	8 GB
System Bandwidth	24 GB/s	16 GB/s	8 GB/s	2 GB/s	2 GB/s
Standard Storage	240 GB, SSD	512 GB, SSD	320 GB, HDD	320 GB, HDD	320 GB, HDD
TPM Version	1.2	2.0	-	-	-
Ethernet	2 GbE	2 GbE	2 GbE	2 GbE	1 GbE
USB Ports	4 USB 2.0 2 USB 3.0	4 USB 2.0 2 USB 3.0	4 USB 2.0 2 USB 3.0	4 USB 2.0 2 USB 3.0	2 USB 2.0 2 USB 3.0
Thunderbolt 3 Ports	-	2	-	-	-

Detailed View of PXIe-8880 Embedded Controller

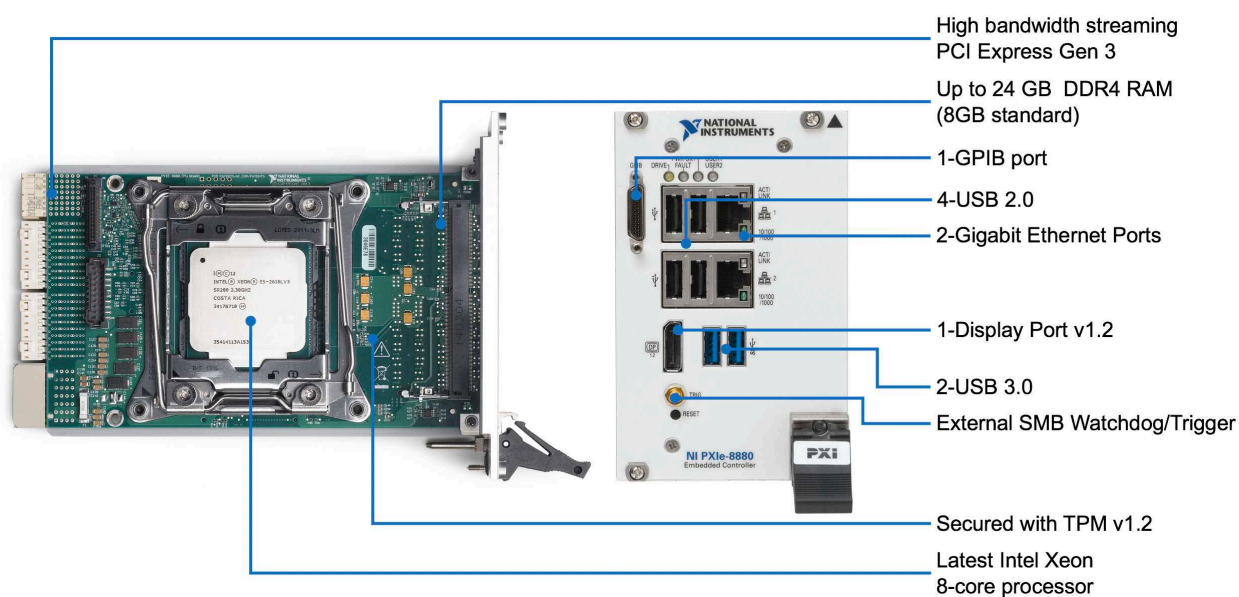

Key Features

Performance

When National Instruments releases a new PXI embedded controller, it offers the controller shortly after major computer manufacturers such as Dell or HP release computers featuring the same high-performance embedded mobile processor. This trend illustrates the company's design expertise and commitment to providing the instrumentation industry with high-performance PXI embedded controllers that take advantage of the latest PC technologies, such as the Intel Atom, Core i7 processor, or [Xeon processor](#). Also, because NI has been in the business of releasing PXI embedded controllers for over 20 years, the company has developed a close working relationship with key processor manufacturers such as Intel and Advanced Micro Devices (AMD). For example, NI is an associate member of the Intel Intelligent Systems Alliance, which offers access to the latest Intel product roadmaps and samples.

In addition to computing performance, I/O bandwidth plays a critical role in designing instrumentation systems. As modern test and measurement systems become more complex, there is a growing need to exchange more and more data between the instruments and the system controller. With the introduction of PCI Express and PXI Express, NI embedded controllers have met this need and now deliver up to 24 GB/s of system bandwidth to the PXI Express chassis backplane.

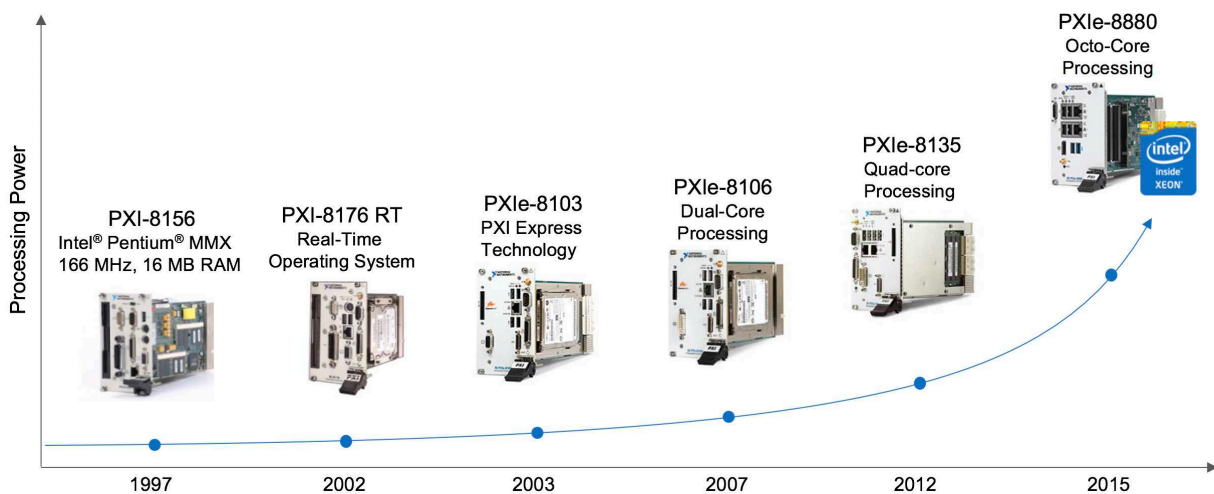

Figure 1: NI has continued to incorporate the latest PC technologies into its PXI controllers.

As the PCI Express standard evolved to PCI Express 3.0, PXI Express continued to take advantage of new features. The [PXIe-8880](#) uses the advancements of PCI Express technology to offer both one x16 and one x8 Gen 3 PCI Express link for interfacing to the PXI chassis backplane.

Using the [PXIe-8880](#) with a Gen 3 PXI Express chassis, such as the [PXIe-1095](#), provides total system data throughput up to 24 GB/s. With this high bandwidth, you can now easily implement computationally intensive applications that demand high-throughput rates such as next generation wireless communication design and prototyping, RF record and playback, and noise mapping.

Differentiated I/O

NI PXI and PXI Express embedded controllers feature a variety of I/O connectivity to interface to stand-alone instruments or peripheral devices. I/O offerings include up to two Thunderbolt 3, two USB 3.0, four USB 2.0 ports, Dual-Gigabit Ethernet, GPIB, serial, two display ports for dual-monitor support, and parallel ports. Each of these ports directly translates to cost savings because they negate the need to purchase PXI modules that provide this functionality. In addition, you can optimize the usage of the available slots in a PXI chassis because you can use the slots to place measurement modules instead.

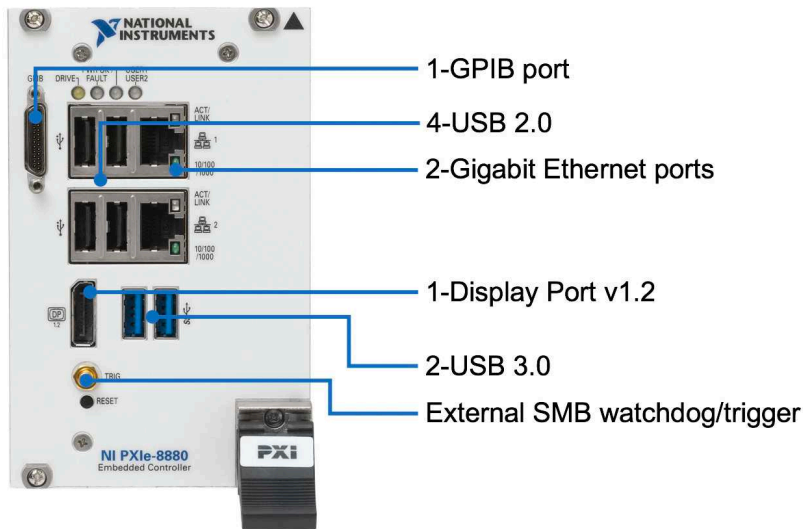

Figure 2: The PXIe-8880 features rich I/O options for peripheral device connections.

Increased Memory and Hard Drive Offering

As the needs of test, measurement, and control applications evolve, NI continues to expand the accessories portfolio of the PXI embedded controller to ensure optimal performance. For memory-intensive applications, NI offers the PXIe-8861 embedded controller with memory upgrade options up to 32 GB RAM. To align with the memory upgrade options, Windows 10 64-bit is available on the highest performance controllers to ensure your applications can fully access all available system RAM.

NI also provides a variety of storage upgrade options. These options range from high-capacity standard hard disk drives (HDD) to solid-state drives (SSD). When storing instrumentation data from your application, it is convenient to store to the onboard HDD/SSD on the embedded controller. To ensure enough space for all desired data, NI offers an option to upgrade your standard HDD or SSD to a larger capacity HDD or SSD, for example 800 GB SSD with the PXIe-8880, to maximize storage space.

For harsh environments where you want to operate the controller or store data, SSDs are ideal. These drives do not have any moving parts; therefore, they significantly reduce risk due to mechanical failure, resulting in improved system reliability. They can also withstand extreme shock, high altitude and vibration, and other harsh operation environments. Besides better tolerance for harsh operating environments and increased reliability, SSDs provide lower read and write seek times as compared to standard rotating medium hard drives. This translates to higher sequential and random data read and write rates. Applications using SSDs experience faster application load times and overall test-time savings due to faster file I/O.

High Reliability

PXI embedded controllers continuously feature the latest processors on the market. To ensure that the embedded controller offers optimal performance over the entire operating range, NI performs extensive thermal, mechanical, and electrical testing to ensure that the CPU in an NI PXI embedded controller doesn't throttle its processor performance when used in extreme environments. Ensuring the CPU's proper performance and reliability increases the overall reliability of the PXI system. NI accomplishes this by using its expertise in developing embedded controllers and applying techniques such as advanced design simulation and designing custom heat sinks. You can also choose a solid-state hard drive instead of the standard, rotating-medium hard drive to further improve the reliability of the entire system, particularly in harsh environments. Because of this unique design consideration by NI, you can deploy PXI-based instruments in more challenging applications.

To ensure determinism and offer even higher reliability, NI offers PXI embedded controllers that run a real-time OS and LabVIEW Real-Time Module software instead of standard Windows OSs. Systems

running Windows or other general-purpose OSs cannot guarantee the completion of a certain task in a specified time because the OS shares the processor with other system processes running in parallel. With LabVIEW Real-Time running on the embedded controller, the entire processor is dedicated to running your specific application, which ensures deterministic and reliable behavior.

Integrated Tools to Improve System Availability and Manageability

NI works closely with Intel to ensure features of the latest processor are incorporated into PXI embedded controllers, enabling PXI applications to take advantage of these new tools. [Intel Active Management Technology \(AMT\)](#), which provides system administrators the ability to remotely monitor, maintain, and update systems. With this feature, administrators can boot systems from a remote media, track hardware and software assets, and perform remote troubleshooting and recovery.

You can use this feature to manage deployed automated test or control systems that need high uptime. Test, measurement, and control applications can use AMT to collect data remotely and monitor application status. When an application or system failure occurs, AMT gives you the ability to remotely diagnose the problem and access debug screens. The problem is resolved sooner and no longer requires interaction with the actual system. With AMT, you can remotely update software when required, ensuring that the system is updated as quickly as possible since downtime can be very costly. AMT can provide many remote management benefits for PXI systems.

The Trusted Platform Module (TPM) is a component on select embedded controllers that is specifically designed to enhance platform security above and beyond the capabilities of today's software by providing a protected space for key operations and other security critical tasks. Using both hardware and software, the TPM protects encryption and signature keys at their most vulnerable stages—operations when the keys are being used unencrypted in plain-text form. The TPM is specifically designed to shield unencrypted keys and platform authentication information from software-based attacks. The PXIe-8880 is equipped with TPM v1.2, while the PXIe-8861 is equipped with TPM v 2.0.

Often to deploy test and measurement systems in classified areas, you need these systems to have an associated declassification process. Declassifying a PXI system requires knowledge of all memory components in the system including the chassis, controller, and modules. PXI embedded controllers feature nonvolatile storage in the form of a hard drive or a flash drive that retains user and system information, even after the system is powered down. Because nonvolatile storage is required for the PXI embedded controller to operate, the PXIe-8135 and PXIe-8861 offer variants with removable drives that provide the ability to remove this storage media so that it can be placed in a secure environment.

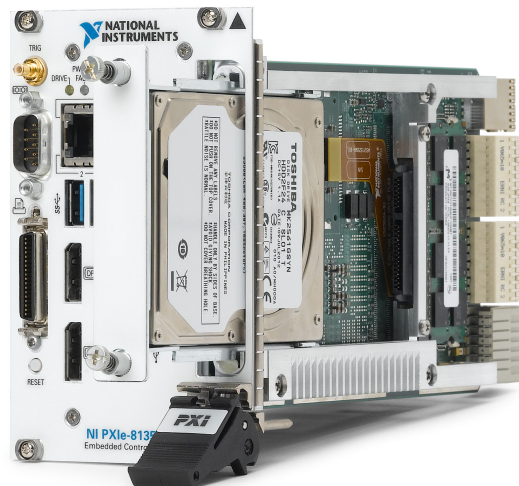
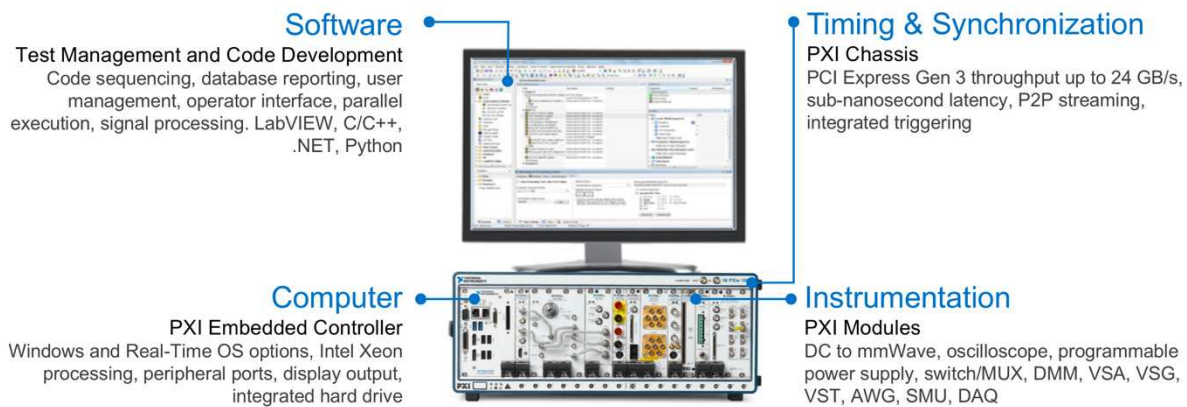

Figure 3: The PXIe-8135 offers a removable hard disk drive.

Platform-Based Approach to Test and Measurement





What Is PXI?

Powered by software, PXI is a rugged PC-based platform for measurement and automation systems. PXI combines PCI electrical-bus features with the modular, Eurocard packaging of CompactPCI and then adds specialized synchronization buses and key software features. PXI is both a high-performance and low-cost deployment platform for applications such as manufacturing test, military and aerospace, machine monitoring, automotive, and industrial test. Developed in 1997 and launched in 1998, PXI is an open industry standard governed by the PXI Systems Alliance (PXISA), a group of more than 70 companies chartered to promote the PXI standard, ensure interoperability, and maintain the PXI specification.



Integrating the Latest Commercial Technology

By leveraging the latest commercial technology for our products, we can continually deliver high-performance and high-quality products to our users at a competitive price. The latest PCI Express Gen 3 switches deliver higher data throughput, the latest Intel multicore processors facilitate faster and more efficient parallel (multisite) testing, the latest FPGAs from Xilinx help to push signal processing algorithms to the edge to accelerate measurements, and the latest data converters from TI and ADI continually increase the measurement range and performance of our instrumentation.

<p>HIGHER DATA THROUGHPUT</p>  <p>PCI Express Gen 3</p>	<p>PARALLEL TEST EXECUTION</p>  <p>Multicore Processors</p>	<p>MEASUREMENT ACCELERATION</p>  <p>FPGAs</p>	<p>INCREASED MEASUREMENT RANGE</p>  <p>Data Converters</p>
--	--	---	---

PXI Instrumentation

NI offers more than 600 different PXI modules ranging from DC to mmWave. Because PXI is an open industry standard, nearly 1,500 products are available from more than 70 different instrument vendors. With standard processing and control functions designated to a controller, PXI instruments need to contain only the actual instrumentation circuitry, which provides effective performance in a small footprint. Combined with a chassis and controller, PXI systems feature high-throughput data movement using PCI Express bus interfaces and sub-nanosecond synchronization with integrated timing and triggering.



Oscilloscopes

Sample at speeds up to 12.5 GS/s with 5 GHz of analog bandwidth, featuring numerous triggering modes and deep onboard memory



Digital Multimeters

Perform voltage (up to 1000 V), current (up to 3A), resistance, inductance, capacitance, and frequency/period measurements, as well as diode tests



Digital Instruments

Perform characterization and production test of semiconductor devices with timing sets and per channel pin parametric measurement unit (PPMU)



Waveform Generators

Generate standard functions including sine, square, triangle, and ramp as well as user-defined, arbitrary waveforms



Frequency Counters

Perform counter timer tasks such as event counting and encoder position, period, pulse, and frequency measurements



Source Measure Units

Combine high-precision source and measure capability with high channel density, deterministic hardware sequencing, and SourceAdapt transient optimization



Power Supplies & Loads

Supply programmable DC power, with some modules including isolated channels, output disconnect functionality, and remote sense



FlexRIO Custom Instruments & Processing

Provide high-performance I/O and powerful FPGAs for applications that require more than standard instruments can offer



Switches (Matrix & MUX)

Feature a variety of relay types and row/column configurations to simplify wiring in automated test systems



Vector Signal Transceivers

Combine a vector signal generator and vector signal analyzer with FPGA-based, real-time signal processing and control



GPIO, Serial, & Ethernet

Integrate non-PXI instruments into a PXI system through various instrument control interfaces



Data Acquisition Modules

Provide a mix of analog I/O, digital I/O, counter/timer, and trigger functionality for measuring electrical or physical phenomena

Hardware Services

All NI hardware includes a one-year warranty for basic repair coverage, and calibration in adherence to NI specifications prior to shipment. PXI systems also include basic assembly and a functional test. NI offers additional entitlements to improve uptime and lower maintenance costs with service programs for hardware. Learn more at ni.com/services/hardware.

	Standard	Premium	Description
Program Duration	1, 3, or 5 years	1, 3, or 5 years	Length of service program
Extended Repair Coverage	•	•	NI restores your device's functionality and includes firmware updates and factory calibration.
System Configuration, Assembly, and Test ¹	•	•	NI technicians assemble, install software in, and test your system per your custom configuration prior to shipment.
Advanced Replacement ²		•	NI stocks replacement hardware that can be shipped immediately if a repair is needed.
System Return Material Authorization (RMA) ¹		•	NI accepts the delivery of fully assembled systems when performing repair services.
Calibration Plan (Optional)	Standard	Expedited ³	NI performs the requested level of calibration at the specified calibration interval for the duration of the service program.

¹This option is only available for PXI, CompactRIO, and CompactDAQ systems.

²This option is not available for all products in all countries. Contact your local NI sales engineer to confirm availability.

³Expedited calibration only includes traceable levels.

PremiumPlus Service Program

NI can customize the offerings listed above, or offer additional entitlements such as on-site calibration, custom sparring, and life-cycle services through a PremiumPlus Service Program. Contact your NI sales representative to learn more.

Technical Support

Every NI system includes a 30-day trial for phone and e-mail support from NI engineers, which can be extended through a [Software Service Program \(SSP\)](#) membership. NI has more than 400 support engineers available around the globe to provide local support in more than 30 languages. Additionally, take advantage of NI's award winning [online resources](#) and [communities](#).

©2019 National Instruments. All rights reserved. LabVIEW, National Instruments, NI, NI TestStand, and ni.com are trademarks of National Instruments. Other product and company names listed are trademarks or trade names of their respective companies. The contents of this Site could contain technical inaccuracies, typographical errors or out-of-date information. Information may be updated or changed at any time, without notice. Visit ni.com/manuals for the latest information.

10 December 2019