

COMPREHENSIVE SERVICES

We offer competitive repair and calibration services, as well as easily accessible documentation and free downloadable resources.

SELL YOUR SURPLUS

We buy new, used, decommissioned, and surplus parts from every NI series. We work out the best solution to suit your individual needs.

 Sell For Cash  Get Credit  Receive a Trade-In Deal

OBSOLETE NI HARDWARE IN STOCK & READY TO SHIP

We stock **New**, **New Surplus**, **Refurbished**, and **Reconditioned** NI Hardware.



Bridging the gap between the manufacturer and your legacy test system.

 1-800-915-6216

 www.apexwaves.com

 sales@apexwaves.com

All trademarks, brands, and brand names are the property of their respective owners.

Request a Quote

 **CLICK HERE**

PXIe-4140

CALIBRATION PROCEDURE

NI PXIe-4140

Four Channel Precision Source-Measure Unit (SMU)

This document contains the verification and adjustment procedures for the NI PXIe-4140 (NI 4140). Refer to ni.com/calibration for more information about calibration solutions.

Contents

Verification.....	2
Required Software.....	2
Related Documentation.....	2
Password.....	2
Calibration Interval.....	2
Test Equipment.....	2
Test Conditions.....	3
Calibration Overview.....	4
Self-Calibrating.....	5
Voltage Output and Measurement.....	5
Current Output and Measurement.....	7
Remote Sense.....	9
Adjustment.....	12
Adjusted Specifications.....	13
Self-Calibrating.....	13
Initiating the Adjustment Session.....	13
Connecting and Configuring Equipment for Voltage Adjustment.....	13
Adjusting Voltage Measurement.....	14
Connecting and Configuring Equipment for Current Adjustment.....	15
Adjusting Current Measurement.....	15
Connecting and Configuring Equipment to Adjust Residual Offset Voltage.....	16
Adjusting Residual Voltage Offset.....	17
Adjusting Residual Current Offset.....	17
Closing the Adjustment Session.....	17
Alternative to Adjustment Procedures.....	17
Reverification.....	18
Worldwide Support and Services.....	18

Verification

The performance verification procedures assume that adequate traceable uncertainties are available for the calibration references.

Related Information

[Reverification](#) on page 18

Repeat the *Verification* section to determine the as-left status of the device.

Required Software

Calibrating the NI 4140 requires you to install the following software on the calibration system:

- NI-DCPower. The NI 4140 was first supported in NI-DCPower 1.7.5.
- Supported application development environment (ADE)—LabVIEW or LabWindows™/CVI™
- Supported operating system—Windows

You can download all required software from ni.com/downloads.

Related Documentation

You might find the following documents helpful as you perform the calibration procedure:

- *NI DC Power Supplies and SMUs Getting Started Guide*
- *NI DC Power Supplies and SMUs Help*
- *NI PXIe-4140 Specifications*
- *NI-DCPower Readme*

Visit ni.com/manuals for the latest versions of these documents.

Password

The default password for password-protected operations is NI.

Calibration Interval

Recommended calibration interval.....1 year

Test Equipment

The following table lists the equipment NI recommends for the performance verification and adjustment procedures. If the recommended equipment is not available, select a substitute using the minimum requirements listed in the table.

Table 1. Required Equipment for Calibration

Required Equipment	Recommended Model(s)	Where Used	Minimum Specifications
Digital multimeter (DMM)	Agilent 3458A ¹	All parameters	Voltage: $\leq \pm 26$ ppm accuracy and $< 1 \mu\text{V}$ resolution Current: $\leq \pm 100$ ppm accuracy and $< 5 \text{ pA}$ resolution
Two 50 Ω resistors	Vishay PTF5650R000BZEK	Voltage remote sense	0.1% tolerance, 1/8 W
Two 10 Ω resistors	Vishay CMF5510R000BEEK	Current remote sense	0.1% tolerance, 1/4 W
Two 100 Ω resistors	Vishay PTF65100R000BYEK	Current remote sense	0.1% tolerance, 1/4 W
Two 1 k Ω resistors	Vishay PTF651K0000BYEK	Voltage and current remote sense	0.1% tolerance, 1/4 W
Two 10 k Ω resistors	Vishay PTF6510K000BYEK	Current remote sense	0.1% tolerance, 1/4 W
Two 100 k Ω resistors	Vishay PTF65100K000BYEK	Current remote sense	0.1% tolerance, 1/4 W

Test Conditions

The following setup and environmental conditions are required to ensure the NI 4140 meets published specifications:

- Keep cabling as short as possible. Long cables act as antennas, picking up extra noise that can affect measurements.
- Verify that all connections to the device, including front panel connections and screws, are secure.
- Ensure that the PXI chassis fan speed is set to HIGH, that the fan filters (if present) are clean, and that the empty slots contain slot blockers and filler panels. For more

¹ To take measurements in the 10 μA range with the Agilent 3458A, you must send your device to the Agilent Primary Standards Lab for a special calibration to verify the 10 μA , 1 μA , and 100 nA ranges.

information about cooling, refer to the *Maintain Forced-Air Cooling Note to Users* document available at ni.com/manuals.

- Allow a warm-up time of at least 30 minutes after the chassis is powered on and NI-DCPower is loaded and recognizes the NI 4140. The warm-up time ensures that the NI 4140 and test instrumentation are at a stable operating temperature.
- Use shielded copper wire for all cable connections to the device. Use twisted-pair wire to eliminate noise and thermal offsets.
- To ensure the system has had adequate time to settle, wait one second after requesting a new current or voltage or after changing a load before taking a measurement.
- Keep relative humidity between 10% and 70%, noncondensing.
- Recalculate the test limits if they differ from the newest device specifications. Test limits in this document are based on the July 2013 edition of the *NI PXIe-4140 Specifications*.
- When making measurements, set the **niDCPower Aperture Time** property or `NIDCPOWER_ATTR_APERTURE_TIME` attribute to 2 power-line cycles (PLCs) on the device. Set the **niDCPower Aperture Time Units** property or `NIDCPOWER_ATTR_APERTURE_TIME_UNITS` to power line cycles.
- Do not use the NI-DCPower Soft Front Panel (SFP) to request test points for any adjustment functions because you cannot set aperture time using the SFP.
- Ensure that properties or attributes for the device that are not specified in calibration procedures are set to their default values.
- When making measurements, configure any specified digital multimeters (DMMs) with the best available levels and limits for each specified test point.

Temperature conditions specific to verification procedures:

- Maintain an ambient temperature of $23\text{ }^{\circ}\text{C} \pm 5\text{ }^{\circ}\text{C}$. Maintain an internal device temperature range of $T_{\text{cal}} \pm 5\text{ }^{\circ}\text{C}$.²

Temperature conditions specific to adjustment procedures:

- Maintain an ambient temperature of $23\text{ }^{\circ}\text{C} \pm 1\text{ }^{\circ}\text{C}$. The NI 4140 internal temperature will be greater than the ambient temperature.

Calibration Overview

Calibration includes the steps shown in the following figure.

² T_{cal} is the internal device temperature recorded by the NI 4140 at the completion of the last self-calibration. Call the niDCPower Get Self Cal Last Temp VI to query T_{cal} from the NI 4140.

Figure 1. Calibration Overview

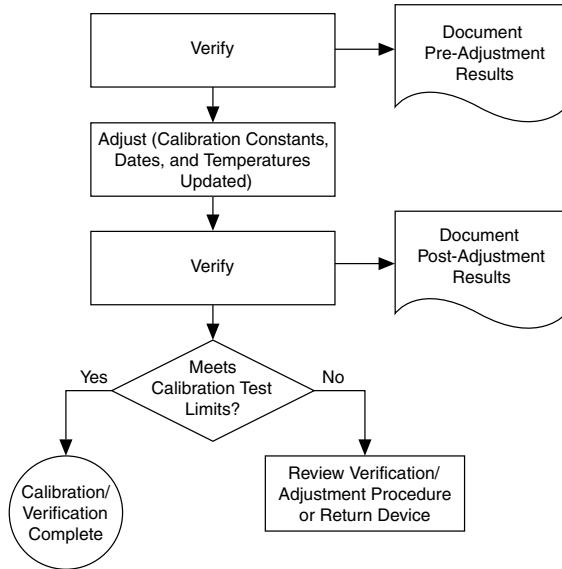

1. Initial Setup—Install the NI 4140 and configure it in Measurement & Automation Explorer (MAX) .
2. Verification—Verify the existing operation of the NI 4140.
This step confirms whether the device is operating within the published specifications prior to adjustment.
3. Adjustment—Adjust the calibration constants of the NI 4140.
4. Reverification—Repeat the Verification procedure to ensure that the device is operating within the published specifications after adjustment.

Self-Calibrating

Complete the following steps to self-calibrate the device.

1. Disconnect or disable all connections to the device.
2. Ensure the device had 30 minutes to warm up with the PXI chassis fans set to HIGH.
3. Initialize an NI-DCPower session.
4. Call the self-calibration function.
5. Close the NI-DCPower session.

Voltage Output and Measurement

Connecting and Configuring Equipment for Voltage Verification

1. Make the necessary connections for this procedure, as shown in the following figure.

Figure 2. Voltage Verification or Adjustment Connection Diagram

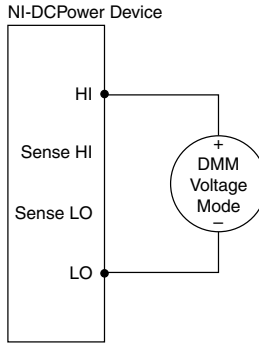

2. Set the **niDCPower Output Function** property or `NIDCPOWER_OUTPUT_FUNCTION` attribute to DC Voltage for the NI 4140.

Verifying Voltage Output and Measurement

Compare a set of voltages measured by the external DMM to both a set of voltage test points requested by the NI 4140 and to the measured voltages reported by the NI 4140.

Refer to the following table as you complete the following steps.

Table 2. Voltage Output and Measurement Verification

Level Range	Limit Range and Limit	Test Point	As-Found Output Test Limit (% of Voltage + Offset)	As-Found Measurement Test Limit (% of Voltage + Offset)
10 V	1 mA	-10 V	0.1% + 5.0 mV	0.1% + 5.0 mV
		-7.5 V		
		5 V		
		-2.5 V		
		0 V		
		2.5 V		
		5 V		
		7.5 V		
		10 V		

1. Set the first specified level range, limit range, and limit on the NI 4140.
2. Set the level on the NI 4140 to the first specified test point.
3. Take a voltage measurement using the DMM, and take a voltage measurement using the NI 4140.

4. Record the values from the previous step.
5. Calculate the lower and upper voltage output test limits using the following formula:
Voltage Output Test Limits = Test Point ± (|Test Point| × % of Voltage + Offset)
6. Verify that the recorded DMM value falls within the test limits.
7. Calculate the lower and upper voltage measurement test limits using the following formula: *Voltage Measurement Test Limits = DMM Measured Voltage ± (|DMM Measured Voltage| × % of Voltage + Offset)*. Record the test limits.
8. Verify that the recorded NI 4140 value falls within the test limits.
9. If more than one test point per level range is specified, repeat the previous steps for each test point, from setting the level to the test point on the NI 4140 up to this step.
10. If more than one level range is specified, repeat the previous steps using the values specified in each level range.

Current Output and Measurement

Connecting and Configuring Equipment for Current Verification

1. Make the necessary connections for this procedure, as shown in the following figure.

Figure 3. Current Verification or Adjustment Connection Diagram

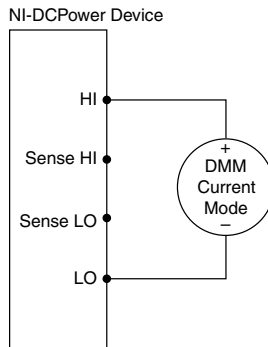

2. Set the **niDCPower Output Function** property or `NIDCPOWER_OUTPUT_FUNCTION` attribute to DC Current for the NI 4140.

Verifying Current Output and Measurement

Compare a set of currents measured by the external DMM to both a set of current test points requested by the NI 4140 and to the measured currents reported by the NI 4140.

Refer to the following table as you complete the following steps.

Table 3. Current Output and Measurement Verification

Level Range	Limit Range and Limit	Test Point	As-Found Output Test Limit (% of Current + Offset)	As-Found Measurement Test Limit (% of Current + Offset)
10 μ A	10 V	-10 μ A	0.1% + 5.0 nA	0.1% + 5.0 nA
		0 μ A		
		10 μ A		
100 μ A	10 V	-100 μ A	0.1% + 50 nA	0.1% + 50 nA
		0 μ A		
		100 μ A		
1 mA	10 V	-100 μ A	0.1% + 500 nA	0.1% + 500 nA
		-750 μ A		
		-500 μ A		
		-250 μ A		
		0 μ A		
		250 μ A		
		500 μ A		
		750 μ A		
		100 μ A		
10 mA	10 V	-10 mA	0.1% + 5.0 μ A	0.1% + 5.0 μ A
		0 mA		
		10 mA		
100 mA	10 V	-100 mA	0.1% + 50 μ A	0.1% + 50 μ A
		0 mA		
		100 mA		

1. Set the first specified level range, limit range, and limit on the NI 4140.
2. Set the level on the NI 4140 to the first specified test point.
3. Take a current measurement using the DMM, and take a current measurement using the NI 4140.
4. Record the values from the previous step.

5. Calculate the lower and upper current output test limits using the following formula:
Current Output Test Limits = Test Point ± (|Test Point| × % of Current + Offset)
6. Verify that the recorded DMM value falls within the test limits.
7. Calculate the lower and upper current measurement test limits using the following formula: *Current Measurement Test Limits = DMM Measured Current ± (|DMM Measured Current| × % of Current + Offset).*
8. Verify that the recorded NI 4140 value falls within the test limits.
9. If more than one test point per level range is specified, repeat the previous steps for each test point, from setting the level to the test point on the NI 4140 up to this step. For zero current test points, disconnect all external equipment from the I/O connector on the NI 4140 and take a current measurement solely with the NI 4140, in order to ensure that the output current is zero. In calculations for zero current test points, substitute 0 A for the *DMM Measured Current*.
10. If more than one level range is specified, repeat the previous steps using the values specified in each level range.

Remote Sense

Connecting and Configuring Equipment for Voltage Remote Sense Accuracy Verification

1. Make the necessary connections for this procedure, as shown in the following figure.

Figure 4. Voltage Remote Sense Output Verification Connection Diagram

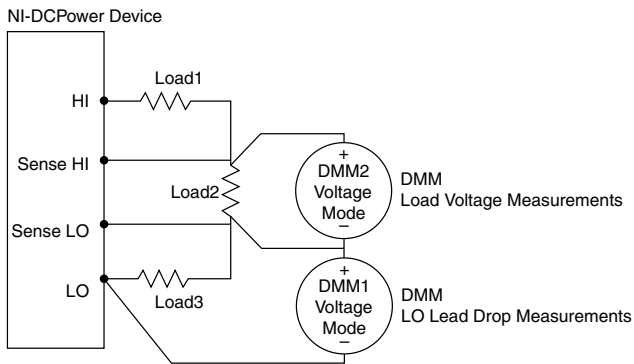

2. Set the **niDCPower Sense** property or `NIDCPOWER_ATTR_SENSE` attribute to Remote.
3. Set the **niDCPower Output Function** property or `NIDCPOWER_OUTPUT_FUNCTION` attribute to DC Voltage for the NI 4140.

Verifying Voltage Remote Sense Accuracy

Use the NI 4140 in constant voltage mode with a test circuit to simulate the voltage drop between the device and a load.

Complete this procedure only after successfully completing all previous Verification procedures.

Refer to the following table as you complete the following steps.

Table 4. Voltage Remote Sense Output Verification

Level Range	Limit Range and Limit	Test Point	Load ₁	Load ₂	Load ₃
10 V	100 mA	10 V	50 Ω	1 kΩ	50 Ω

1. Set the first specified level range, limit range, and limit on the NI 4140.
2. Set the level on the NI 4140 to the first specified test point.
3. Measure the LO lead drop with *DMM1* from the negative terminal of the device to the negative side of *Load2*. Record the measurement as *Lead Drop*.
4. Measure the load voltage with *DMM2* across *Load2* where the sense leads connect. Record the measurement as *Load Voltage*.
5. Calculate the upper and lower voltage remote sense test limits using the following equation: $Voltage\ Remote\ Sense\ Test\ Limit = 10\ V \pm (0.015\ V + LO\ Lead\ Drop \times 0.001)$. Record the test limits.
6. Verify the *Load Voltage* measurement falls within the voltage remote sense test limits.
7. If more than one test point per level range is specified, repeat the previous steps for each test point, from setting the level to the test point on the NI 4140 up to this step.
8. If more than one level range is specified, repeat the previous steps using the values specified in each level range.

Connecting and Configuring Equipment to Verify Current Remote Sense Accuracy

1. Refer to the following figure to make the necessary connections to verify current remote sense accuracy.

Figure 5. Current Remote Sense Output Verification Connection Diagram

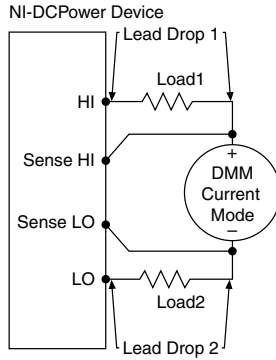

2. Set the **niDCPower Sense** property or `NIDCPOWER_ATTR_SENSE` attribute to Remote.
3. Set the **niDCPower Output Function** property or `NIDCPOWER_OUTPUT_FUNCTION` attribute to DC Current for the NI 4140.

Verifying Current Remote Sense Accuracy

Use the NI 4140 in constant current mode with a test circuit to simulate the voltage drop between the device and a load.

Measure all of the specified resistors using the DMM before you connect equipment. Record the values.

Refer to the following table as you complete the following steps.

Table 5. Current Remote Sense Output Verification

Level Range	Limit Range and Limit	Test Point	Load ₁	Load ₂	Base Limit
10 μ A	10 V	-10 μ A	100 k Ω	100 k Ω	15 nA
		0 μ A			
		10 μ A			
100 μ A	10 V	-100 μ A	10 k Ω	10 k Ω	150 nA
		0 μ A			
		100 μ A			
1 mA	10 V	-1 mA	1 k Ω	1 k Ω	1.5 μ A
		0 mA			
		1 mA			

Table 5. Current Remote Sense Output Verification (Continued)

Level Range	Limit Range and Limit	Test Point	Load ₁	Load ₂	Base Limit
10 mA	10 V	-10 mA	100 Ω	100 Ω	15 μA
		0 mA			
		10 mA			
100 mA	10 V	-100 mA	10 Ω	10 Ω	150 μA
		0 mA			
		100 mA			

1. Set the first specified level range, limit range, and limit on the NI 4140.
2. Set the level on the NI 4140 to the first specified test point.
3. Calculate the total lead drop using the following steps.
 - a) Take a current measurement using the DMM. Record the value.
 - b) Calculate the voltage across *Load1* using the following formula: *DMM Measured Current * Load1*. Record as *Lead Drop 1*.
 - c) Calculate the voltage across *Load2* using the following formula: *DMM Measured Current * Load2*. Record as *Lead Drop 2*.
 - d) Calculate the total lead drop using the following equation: *Total Lead Drop = Lead Drop 1 + Lead Drop 2*. Record the value.
4. Calculate the upper and lower current remote sense test limits using the following equation: *Current Remote Sense Test Limit = Test Point ± (Base Limit + (Total Lead Drop × 0.02% of Level Range)*. Record the test limits.
5. Verify the recorded DMM current falls within the test limits.
6. If more than one test point per level range is specified, repeat the previous steps for each test point, from setting the level to the test point on the NI 4140 up to this step.
7. If more than one level range is specified, repeat the previous steps using the values specified in each level range.

Adjustment

This section describes the steps needed to adjust the NI 4140 to meet published specifications.

Related Information

[For information on VIs and functions used in adjustment, refer to the NI DC Power and SMUs Help](#)

Adjusted Specifications

Adjustment corrects the following specifications for the device:

- Voltage programming accuracy
- Current programming accuracy
- Voltage measurement accuracy
- Current measurement accuracy

Following the adjustment procedure automatically updates the calibration date and temperature on the device.



Note You do not need to separately adjust both measurement and output. The architecture of the NI 4140 ensures that if measurement is accurate, then output is as well, and vice versa.

Self-Calibrating

Complete the following steps to self-calibrate the device.

1. Disconnect or disable all connections to the device.
2. Ensure the device had 30 minutes to warm up with the PXI chassis fans set to HIGH.
3. Initialize an NI-DCPower session.
4. Call the self-calibration function.
5. Close the NI-DCPower session.

Initiating the Adjustment Session

Initiate an external calibration session (a special type of NI-DCPower session) by calling the `niDCPower Initialize External Calibration VI` or `niDCPower_InitExtCal` function.

(Optional) You can close the session and commit the new constants to hardware after you complete each adjustment procedure.

Related Information

[Closing the Adjustment Session](#) on page 17

Connecting and Configuring Equipment for Voltage Adjustment

1. Make the necessary connections for this procedure, as shown in the following figure.

Figure 6. Voltage Verification or Adjustment Connection Diagram

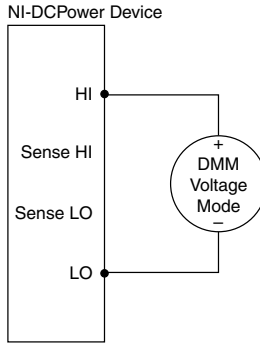

2. Set the **niDCPower Output Function** property or `NIDCPOWER_OUTPUT_FUNCTION` attribute to DC Voltage for the NI 4140.

Adjusting Voltage Measurement

Compare a set of measured voltages reported by the NI 4140 to the voltages measured by an external DMM. You do not need to separately verify or adjust both measurement and output. The architecture of the NI 4140 ensures that if measurement is accurate, then output is as well, and vice versa.

Refer to the following table as you complete the following steps.

Table 6. Voltage Measurement Adjustment

Level Range	Limit Range and Limit	Test Point
10 V	1 mA	10 V
		-10 V

1. Set the first specified level range, limit range, and limit on the NI 4140.
2. Set the level on the NI 4140 to the first specified test point.
3. Take a voltage measurement using the DMM, and take a voltage measurement using the NI 4140.
4. Store the values from the previous step as inputs for the `niDCPower Cal Adjust VI` or function called in the following steps.
5. If more than one test point per level range is specified, repeat the previous steps for each test point, from setting the level to the test point on the NI 4140 up to this step.
6. If more than one level range is specified, repeat the previous steps using the values specified in each level range.

7. Update the measurement calibration constants by configuring and calling the niDCPower Cal Adjust Voltage Measurement VI or `niDCPower_CalAdjustVoltageMeasurement` function.
 - a) Input the DMM measurements as the **measured outputs**.
 - b) Input the NI 4140 measurements as the **reported outputs**.
 - c) Input the specified level range as the **range**.

Connecting and Configuring Equipment for Current Adjustment

1. Make the necessary connections for this procedure, as shown in the following figure.

Figure 7. Current Verification or Adjustment Connection Diagram

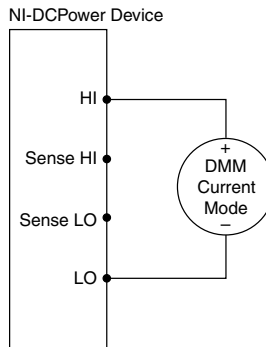

2. Set the **niDCPower Output Function** property or `NIDCPOWER_OUTPUT_FUNCTION` attribute to DC Current for the NI 4140.

Adjusting Current Measurement

Compare a set of measured currents reported by the NI 4140 to the currents measured by an external DMM.

Refer to the following table as you complete the following steps.

Table 7. Current Measurement Adjustment

Level Range	Limit Range and Limit	Test Point
10 μ A	10 V	10 μ A
		-10 μ A
100 μ A	10 V	100 μ A
		-100 μ A

Table 7. Current Measurement Adjustment (Continued)

Level Range	Limit Range and Limit	Test Point
1 mA	10 V	1 mA
		-1 mA
10 mA	10 V	10 mA
		-10 mA
100 mA	10 V	100 mA
		-100 mA

1. Set the first specified level range, limit range, and limit on the NI 4140.
2. Set the level on the NI 4140 to the first specified test point.
3. Take a current measurement using the DMM, and take a current measurement using the NI 4140.
4. Store the values from the previous step as inputs for the `niDCPower Cal Adjust VI` or function called in the following steps.
5. If more than one test point per level range is specified, repeat the previous steps for each test point, from setting the level to the test point on the NI 4140 up to this step. For zero current test points, disconnect all external equipment from the I/O connector on the NI 4140 and take a current measurement solely with the NI 4140, in order to ensure that the output current is zero. In calculations for zero current test points, substitute 0 A for the *DMM Measured Current*.
6. If more than one level range is specified, repeat the previous steps using the values specified in each level range.
7. Update the measurement calibration constants by configuring and calling the VI `niDCPower Cal Adjust Current Measurement` or `niDCPower_CalAdjustCurrentMeasurement` function.
 - a) Input the DMM measurements as the **measured outputs**.
 - b) Input the NI 4140 measurements as the **reported outputs**.
 - c) Input the specified level range as the **range**.

Connecting and Configuring Equipment to Adjust Residual Offset Voltage

1. Make the necessary connections for this procedure, as shown in the following figure.

Figure 8. Residual Voltage Adjustment Diagram

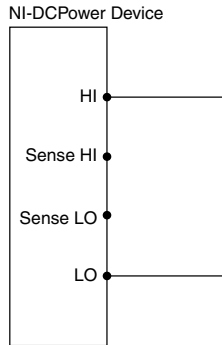

2. Set the **niDCPower Output Function** property or `NIDCPOWER_OUTPUT_FUNCTION` attribute to DC Voltage for the NI 4140.

Adjusting Residual Voltage Offset

Eliminate residual offset voltage at 0 V by configuring and calling the `niDCPower Cal Adjust Residual Voltage Offset VI` or `niDCPower_CalAdjustResidualVoltageOffset` function.

Adjusting Residual Current Offset

1. Disconnect all equipment from the output of the NI 4140.
2. Eliminate offset current at 0 A by configuring and calling the `niDCPower Cal Adjust Residual Current Offset VI` or `niDCPower_CalAdjustResidualCurrentOffset` function.

Closing the Adjustment Session

Close the session and commit the new constants to hardware by calling the `niDCPower Close External Calibration VI` or `niDCPower_CloseExtCal` function and specifying Commit as the **calibration close action**.

Alternative to Adjustment Procedures

If your device passes all verification procedures successfully and you want to skip updating the calibration constants, you can update solely the calibration date by completing the following steps.



Note NI recommends following all adjustment procedures in order to update the calibration constants and renew the device calibration interval.

1. Call one of the following:
 - `niDCPower Initialize External Calibration VI`
 - `niDCPower_InitExtCal` function

2. Call one of the following, specifying Commit in **calibration close action**:
 - niDCPower Close External Calibration VI
 - niDCPower_CloseExtCal function

Reverification

Repeat the *Verification* section to determine the as-left status of the device.



Note If no as-left test limits are specified in a procedure, reuse the as-found test limits.



Note If any test fails reverification after performing an adjustment, verify that you have met the *Test Conditions* before returning your device to NI. Refer to the *Worldwide Support and Services* section for information about support resources or service requests.

Related Information

[Test Conditions](#) on page 3

[Verification](#) on page 2

Worldwide Support and Services

The National Instruments website is your complete resource for technical support. At ni.com/support, you have access to everything from troubleshooting and application development self-help resources to email and phone assistance from NI Application Engineers.

Visit ni.com/services for NI Factory Installation Services, repairs, extended warranty, and other services.

Visit ni.com/register to register your National Instruments product. Product registration facilitates technical support and ensures that you receive important information updates from NI.

A Declaration of Conformity (DoC) is our claim of compliance with the Council of the European Communities using the manufacturer's declaration of conformity. This system affords the user protection for electromagnetic compatibility (EMC) and product safety. You can obtain the DoC for your product by visiting ni.com/certification. If your product supports calibration, you can obtain the calibration certificate for your product at ni.com/calibration.

National Instruments corporate headquarters is located at 11500 North Mopac Expressway, Austin, Texas, 78759-3504. National Instruments also has offices located around the world. For telephone support in the United States, create your service request at ni.com/support or dial 1 866 ASK MYNI (275 6964). For telephone support outside the United States, visit the *Worldwide Offices* section of ni.com/niglobal to access the branch office websites, which

provide up-to-date contact information, support phone numbers, email addresses, and current events.

Refer to the *NI Trademarks and Logo Guidelines* at ni.com/trademarks for information on National Instruments trademarks. Other product and company names mentioned herein are trademarks or trade names of their respective companies. For patents covering National Instruments products/technology, refer to the appropriate location: **Help»Patents** in your software, the `patents.txt` file on your media, or the *National Instruments Patent Notice* at ni.com/patents. You can find information about end-user license agreements (EULAs) and third-party legal notices in the readme file for your NI product. Refer to the *Export Compliance Information* at ni.com/legal/export-compliance for the National Instruments global trade compliance policy and how to obtain relevant HTS codes, ECCNs, and other import/export data. NI MAKES NO EXPRESS OR IMPLIED WARRANTIES AS TO THE ACCURACY OF THE INFORMATION CONTAINED HEREIN AND SHALL NOT BE LIABLE FOR ANY ERRORS. U.S. Government Customers: The data contained in this manual was developed at private expense and is subject to the applicable limited rights and restricted data rights as set forth in FAR 52.227-14, DFAR 252.227-7014, and DFAR 252.227-7015.

© 2012—2015 National Instruments. All rights reserved.

373273E-01 May15