

COMPREHENSIVE SERVICES

We offer competitive repair and calibration services, as well as easily accessible documentation and free downloadable resources.

SELL YOUR SURPLUS

We buy new, used, decommissioned, and surplus parts from every NI series. We work out the best solution to suit your individual needs.

 Sell For Cash  Get Credit  Receive a Trade-In Deal

OBSOLETE NI HARDWARE IN STOCK & READY TO SHIP

We stock **New**, **New Surplus**, **Refurbished**, and **Reconditioned** NI Hardware.



Bridging the gap between the manufacturer and your legacy test system.

 1-800-915-6216

 www.apexwaves.com

 sales@apexwaves.com

All trademarks, brands, and brand names are the property of their respective owners.

Request a Quote

 **CLICK HERE**

USRP-2944

USRP-2940/2942/2943/2944/2945

USRP Software Defined Radio Reconfigurable Device

This document explains how to install, configure, and test the following USRP RIO devices:

- USRP-2940 Software Defined Radio Reconfigurable Device
- USRP-2942 Software Defined Radio Reconfigurable Device
- USRP-2943 Software Defined Radio Reconfigurable Device
- USRP-2944 Software Defined Radio Reconfigurable Device
- USRP-2945 Software Defined Radio Reconfigurable Device

The USRP RIO device can send and/or receive signals for use in various communications applications. The device ships with the NI-USRP instrument driver, which you can use to program the device.

Contents

Verifying the System Requirements.....	2
Unpacking the Kit.....	2
Verifying the Kit Contents.....	3
Environmental Guidelines.....	4
Environmental Characteristics.....	4
Installing the Software.....	4
Installing the Software Using NI Package Manager.....	4
Installing the Software Using the Driver Download Page.....	5
Installing the Device.....	5
Connecting the Device.....	5
Powering on the Device.....	6
Synchronizing Multiple Devices (Optional).....	7
Preparing the USRP-2945 for LO Sharing (Optional).....	7
Preparing the USRP-2945 for LO Re-Import (Optional).....	8
Programming the Device.....	9
NI-USRP Instrument Driver.....	10
Verifying the Device Connection (Optional).....	12
Troubleshooting.....	13
Why Doesn't the Device Power On?.....	13
Why Doesn't the USRP Device Appear in the NI-USRP Configuration Utility?.....	13
Why Does USRP2 Appear Instead of the USRP Device in the NI-USRP Configuration Utility?.....	14
Should I Update Device Firmware and FPGA Images?.....	14
Why Do I Receive an Enumeration Error?.....	14
Why Don't NI-USRP Examples Appear in the NI Example Finder in LabVIEW?.....	15

Front Panels, Back Panels, and Connectors.....	15
Direct Connections to the Device.....	15
USRP-2940 Front Panel, Back Panel, and LEDs.....	15
USRP-2942 Front Panel, Back Panel, and LEDs.....	19
USRP-2943 Front Panel, Back Panel, and LEDs.....	23
USRP-2944 Front Panel, Back Panel, and LEDs.....	26
USRP-2945 Front Panel, Back Panel, and LEDs.....	30
GPIO Connector.....	35
Where to Go Next.....	36
Worldwide Support and Services.....	36

Verifying the System Requirements

To use the NI-USRP instrument driver, your system must meet certain requirements.

Refer to the product readme, which is available online at ni.com/manuals, for more information about minimum system requirements, recommended system, and supported application development environments (ADEs).

Unpacking the Kit



Notice To prevent electrostatic discharge (ESD) from damaging the device, ground yourself using a grounding strap or by holding a grounded object, such as your computer chassis.

1. Touch the antistatic package to a metal part of the computer chassis.
2. Remove the device from the package and inspect the device for loose components or any other sign of damage.



Notice Never touch the exposed pins of connectors.



Note Do not install a device if it appears damaged in any way.

3. Unpack any other items and documentation from the kit.

Store the device in the antistatic package when the device is not in use.

Verifying the Kit Contents

Figure 1. Kit Contents

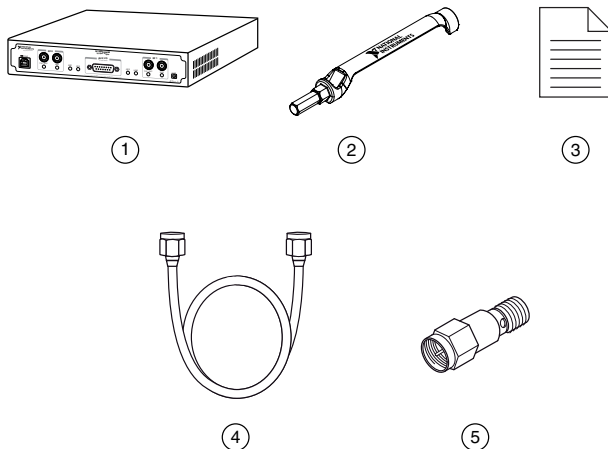

1. USRP RIO Device
2. SMA Driver Bit (USRP-2945 Only)
3. Getting Started Guide (This Document) and Safety, Environmental, and Regulatory Information Document
4. SMA (m)-to-SMA (m) Cable
5. 30 dB SMA Attenuator (Not Included with USRP-2945)



Notice If you directly connect or cable a signal generator to your device, or if you connect multiple devices together, you must connect a 30 dB attenuator to the RF input (RX1 or RX2) of each receiving USRP RIO device.

Other Required Item(s)

In addition to the kit contents, you must provide the following additional item(s):

- An MXI Express interface card. You can purchase an MXI Express interface kit for your USRP RIO device, which contains an MXI Express interface card, at ni.com.

Optional Items

- LabVIEW Modulation Toolkit (MT), available for download at ni.com/downloads and included in LabVIEW Communications System Design Suite, which includes MT VIs and functions, examples, and documentation



Note You must install the LabVIEW Modulation Toolkit for proper operation of the NI-USRP Modulation Toolkit example VIs.

- LabVIEW Digital Filter Design Toolkit, available for download at ni.com/downloads and included in LabVIEW Communications System Design Suite

- LabVIEW MathScript RT Module, available for download at ni.com/downloads
- Additional SMA (m)-to-SMA (m) cables to use the REF IN and PPS IN signals
- PCIe - MXI Express Interface Kit for USRP RIO to connect to a desktop computer
- ExpressCard Slot - MXI Express Interface Kit for USRP RIO to connect to a laptop computer
- PXIe - MXI Express Interface Kit for USRP RIO to connect to a PXI Express chassis
- CDA-2990 Clock Distribution Device for synchronizing multiple devices
- CPS-8910 Switch Device for PCI Express for large multiple-input, multiple-output (MIMO) expansion configurations
- PXI-5691 RF Amplifier for local oscillator (LO) re-import with the USRP-2945

Environmental Guidelines



Notice This model is intended for use in indoor applications only.

Environmental Characteristics

Operating temperature	0 °C to 45 °C
Operating humidity	10% to 90% relative humidity, noncondensing
Pollution Degree	2
Maximum altitude	2,000 m (800 mbar) (at 25 °C ambient temperature)

Installing the Software

You must be an Administrator to install NI software on your computer.

1. Install an application development environment (ADE), such as LabVIEW or LabVIEW Communications System Design Suite.



Note LabVIEW NXG and LabVIEW Communications System Design Suite do not support the USRP-2945.

2. Follow the instructions below that correspond with the ADE that you installed.

Installing the Software Using NI Package Manager

Ensure that you have installed the latest version of NI Package Manager. To access the download page for NI Package Manager, go to ni.com/info and enter info code NIPMDownload.



Note NI-USRP versions 18.1 to current are available to download using NI Package Manager. To download another version of NI-USRP, refer to *Installing the Software Using the Driver Download Page*.

1. To install the latest NI-USRP instrument driver, open NI Package Manager.

2. On the **BROWSE PRODUCTS** tab, click **Drivers** to display all available drivers.
3. Select **NI-USRP** and click **INSTALL**.
4. Follow the instructions in the installation prompts.



Note Windows users may see access and security messages during installation. Accept the prompts to complete the installation.

Related Information

[Refer to the NI Package Manager Manual for instructions on installing NI Package Manager.](#)

Installing the Software Using the Driver Download Page



Note NI recommends using NI Package Manager to download NI-USRP driver software.

1. Visit ni.com/info and enter the Info Code `usrpdriver` to access the driver download page for all versions of NI-USRP software.
2. Download a version of NI-USRP driver software.
3. Follow the instructions in the installation prompts.



Note Windows users may see access and security messages during installation. Accept the prompts to complete the installation.

4. When the installer completes, select **Shut Down** in the dialog box that prompts you to restart, shut down, or restart later.

Installing the Device

Install all the software you plan to use before you install the hardware. Ensure that the USRP RIO device and computer are off before installing.

Connect any additional attachments required for your project to the front panel terminals of the USRP RIO device.

Connecting the Device

The USRP RIO device must be connected either to a desktop computer or a laptop computer.



Notice Never turn the USRP RIO device off or on while the computer is on.

Connecting to a Desktop Computer

Connect the USRP RIO device to a desktop computer using an MXI Express interface kit.

1. Insert the MXI card into your computer according to the installation instructions in the *Hardware Installation* section of the *Set Up Your MXI™ Express ×4 System* document included in your MXI Express interface kit.

2. Connect the MXI device to the USRP RIO device using the PCIe cable included in your MXI Express interface kit.

Connecting to a Laptop Computer

Connect the USRP RIO device to a laptop computer using the ExpressCard-8360 for USRP Device for PXI Remote Control.

1. Touch the ExpressCard-8360 for USRP and outer metal case of the USRP RIO device simultaneously.
2. Connect the included cable to the to the ExpressCard-8360 for USRP.
3. Plug the ExpressCard-8360 for USRP into an available ExpressCard slot.

The completed hardware setup is shown in the following figure.

Figure 2. Connecting the Device with a Laptop Connectivity Kit

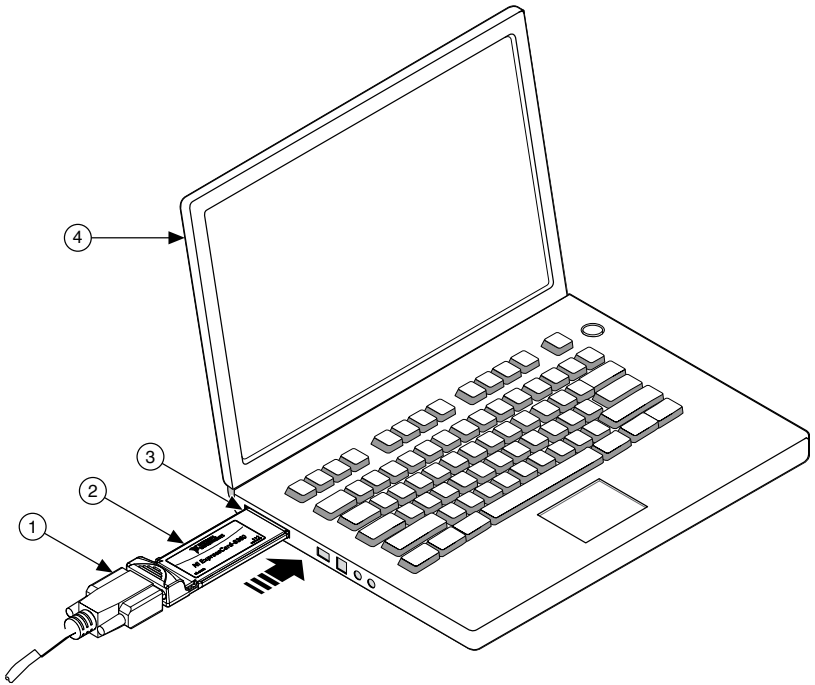

- | | |
|--|---------------------|
| 1. Cable Included with ExpressCard Interface Kit | 3. ExpressCard Slot |
| 2. ExpressCard-8360 for USRP | 4. Laptop Computer |

Powering on the Device

1. Connect the power supply to the USRP RIO device.
2. Plug the power supply into a wall outlet. Press the **PWR** button.
3. Power on the computer or laptop.

Windows automatically recognizes the USRP RIO device.

Synchronizing Multiple Devices (Optional)

To set up a higher channel-count system, you can synchronize two or more USRP RIO devices so that they share clock and pulse per second (PPS) signals.



Note Synchronizing multiple USRP RIO devices requires a CDA-2990 accessory.

Ensure that all hardware is set up as previously described.

1. Connect the REF IN port of the USRP RIO device to the first 10 MHz OUT port of the CDA-2990 using a standard SMA (m)-to-SMA (m) cable.
2. Connect the PPS TRIG IN port of the USRP RIO device to the PPS OUT port of the CDA-2990 using a standard SMA (m)-to-SMA (m) cable.
3. Repeat steps 1 and 2 to synchronize additional USRP RIO devices using the additional ports on the CDA-2990 (optional).

The completed hardware setup for two USRP RIO devices is shown in the following figure.

Figure 3. USRP Device Synchronization Configuration

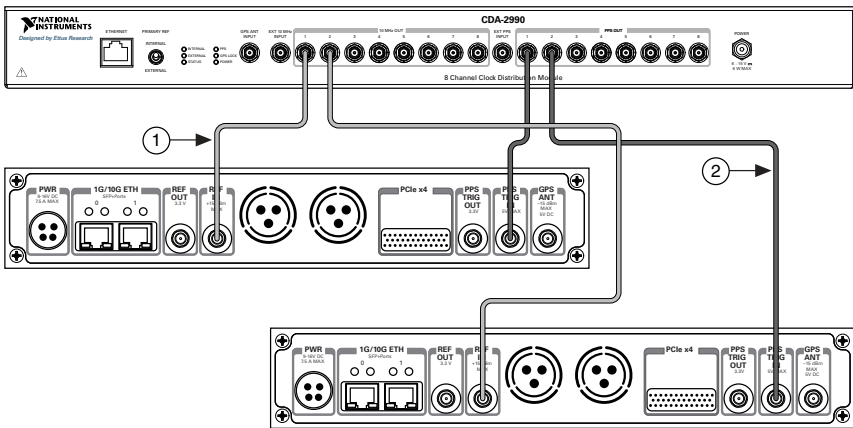

1. SMA (m)-to-SMA (m) Cables
2. SMA (m)-to-SMA (m) Cables

Preparing the USRP-2945 for LO Sharing (Optional)

Complete the following steps to prepare a single USRP-2945 device to share LOs among all four of the device's channels.

1. Connect the LO OUT 1 IF2 connector of the USRP-2945 back panel to the LO IN 0 IF2 connector of the same USRP-2945 back panel using an SMA (m)-to-SMA (m) cable.
2. Connect the LO OUT 1 IF1 connector of the USRP-2945 back panel to the LO IN 0 IF1 connector of the same USRP-2945 back panel using an SMA (m)-to-SMA (m) cable.

The completed hardware setup is shown in the following figure.

Figure 4. USRP-2945 Single Device LO Sharing

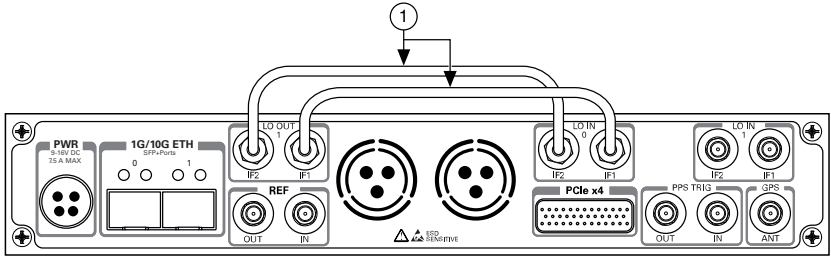

1. SMA(m)-to-SMA(m) Cables

Preparing the USRP-2945 for LO Re-Import (Optional)

Complete the following steps to prepare a single USRP-2945 device to export LO OUT 1 and re-import to LO IN 1 and LO IN 0.

1. Connect the LO OUT 1 IF2 connector of the USRP-2945 back panel to the IN connector of an RF power amplifier front panel using an SMA (m)-to-SMA (m) cable.
2. Connect the OUT connector of the RF power amplifier to the input port of a two-way RF power splitter using an SMA (m)-to-SMA (m) cable.
3. Connect the two output ports of the RF power splitter front panel to the LO IN 0 IF2 and LO IN 1 IF2 connectors of the USRP-2945 back panel using SMA (m)-to-SMA (m) cables.
4. Repeat steps 1 through 3 using a second splitter and additional cables to re-import and share the IF1 signal.

The completed hardware setup is shown in the following figure.

Figure 5. LO Re-Import Configuration

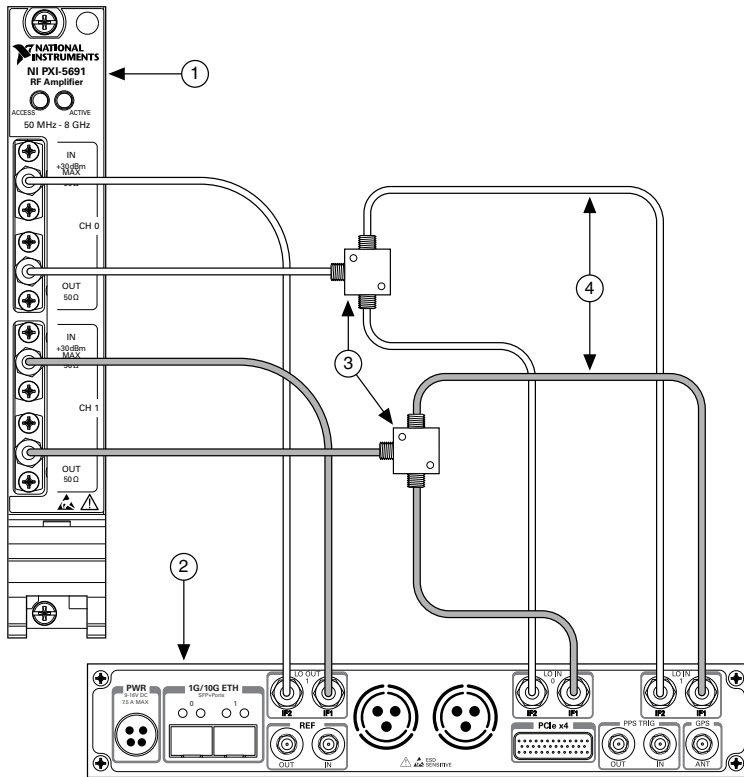

1. RF Power Amplifier
2. USRP RIO Device

3. RF Power Splitters
4. SMA (m)-to-SMA (m) Cables

Programming the Device

You can use the NI-USRP instrument driver to create communications applications for the USRP RIO device.

USRP RIO devices are LabVIEW FPGA targets, which support creating custom FPGAs and configuring the device using Instrument Design Libraries (IDLs).



Note You must use the PCIe x4 connector if you want to program the FPGA. You cannot use the 1G/10G ETH connector to program the FPGA.

NI-USRP Instrument Driver

The NI-USRP instrument driver features a set of functions and properties that exercise the capabilities of the USRP RIO device, including configuration, control, and other device-specific functions.

Related Information

Refer to the [NI-USRP Manual](#) for information about using the instrument driver in your applications.

Software Options

NI provides two software options for programming the USRP RIO device: the NI-USRP API and the USRP RIO IDL.



Note You cannot use the USRP RIO IDLs with the NI-USRP API.

Table 1. Software Options

Software Option	Description	Use Case	Palette Location
NI-USRP API	<p>Provides an API for interacting with your USRP RIO device.</p> <p>Provides the standard, CPU-based host operation needed for most software-defined radio (SDR) applications.</p>	<p>Create custom measurements or applications that require in-phase/quadrature modulation (I/Q) data.</p> <p>Use with the Modulation Toolkit to develop SDR transmitters and receivers.</p> <p>Use with the Modulation Toolkit to create and generate modulated signals.</p>	<p>LabVIEW NXG and LabVIEW Communications System Design Suite: Diagram» Hardware Interfaces» Wireless Design and Test»NI-USRP</p> <p>LabVIEW: Functions» Instrument I/O» Instrument Drivers»NI-USRP</p>
USRP RIO IDL	<p>Allows you to interface with the FPGA of your USRP RIO device for advanced programming and digital signal processing (DSP).</p> <p>Uses the USRP RIO Sample Projects, which allow you to take common measurements with your device. USRP RIO Sample Projects are included in the installation.</p>	<p>Use with the LabVIEW FPGA Module to customize the behavior of the device FPGA to create application-specific instrument designs.</p>	<p>LabVIEW NXG and LabVIEW Communications System Design Suite: Diagram» Hardware Interfaces» Wireless Design and Test»USRP RIO</p> <p>LabVIEW: Functions» Instrument I/O» Instrument Drivers» USRP RIO</p>

NI-USRP Examples, Lessons, and Sample Projects

NI-USRP includes several examples, lessons, and sample projects for LabVIEW, LabVIEW NXG, and LabVIEW Communications System Design Suite. They can be used individually or as components of other applications.

NI-USRP examples, lessons, and sample projects are available in the following locations.

Content Type	Description	LabVIEW	LabVIEW NXG 2.1 to Current or LabVIEW Communications System Design Suite 2.1 to Current
Examples	<p>NI-USRP includes several example applications that serve as interactive tools, programming models, and building blocks in your own applications. NI-USRP includes examples for getting started and other software-defined radio (SDR) functionality.</p> <p> Note You can access additional examples from the Code Sharing Community at ni.com/usrp.</p>	<ul style="list-style-type: none"> From the Start menu at Start»All Programs»National Instruments»NI-USRP»Examples. From the LabVIEW Functions palette at Instrument I/O»Instrument Drivers»NI-USRP»Examples. 	<ul style="list-style-type: none"> From the Learning tab, select Examples»Hardware Input and Output»NI-USRP. From the Learning tab, select Examples»Hardware Input and Output»NI-USRP RIO.
Lessons	<p>NI-USRP includes lessons that guide you through the process of identifying and demodulating an FM signal with your device.</p>	-	<p>From the Learning tab, select Lessons»Getting Started»Demodulating FM Signals with the NI... and choose a task to accomplish.</p>
Sample Projects	<p>USRP RIO includes several sample projects that serve as starting points to build a USRP RIO streaming application.</p>	<p>From the Create Project dialog, select Sample Projects in the left pane and navigate to the NI-USRP Simple Streaming project.</p>	<p>From the Projects tab, select USRP RIO and choose the applicable sample project for your device and setup.</p>



Note The NI Example Finder does not include NI-USRP examples.

Verifying the Device Connection (Optional)

Complete the steps appropriate for your installed ADE to verify the device connection.

Verifying the Device Connection Using LabVIEW NXG or LabVIEW Communications System Design Suite 2.1 to Current

Use USRP Rx Continuous Async to confirm that the device receives signals and is connected correctly to the host computer.

1. Navigate to **Learning»Examples »Hardware Input and Output»NI-USRP»NI-USRP**.
2. Select **Rx Continuous Async**. Click **Create**.
3. Run USRP Rx Continuous Async.

If the device is receiving signals you will see data on the front panel graphs.

4. Click **STOP** to conclude the test.

Using LabVIEW

Run a VI to confirm that the device transmits and/or receives signals and is connected correctly to the host computer.

1. Create a sample project in LabVIEW by selecting **File»Create Project»NI-USRP**.
2. Select the NI-USRP Simple Streaming sample project template and click **Next**.
3. Run the appropriate streaming VI according to your USRP RIO device.

Device	VI
USRP-2940/2942/2943/2944	Tx and Rx Streaming Host VI
USRP-2945	Rx Streaming (Host) VI

If the device is transmitting and/or receiving signals, the front panel graphs display waveform data.

4. Click **STOP** to conclude the test.

Troubleshooting

If an issue persists after you complete a troubleshooting procedure, contact NI technical support or visit ni.com/support.

Why Doesn't the Device Power On?

If you cannot power on the device, complete the following steps.

- Verify that the device is connected to the power supply.
- Verify that the power supply is functional.
- Verify that the power switch on the front of the device is engaged.

Why Doesn't the USRP Device Appear in the NI-USRP Configuration Utility?

Check the connection between the USRP RIO device and the computer. Ensure that the USRP RIO device is powered on and connected to a computer before you power on the computer.

Why Does USRP2 Appear Instead of the USRP Device in the NI-USRP Configuration Utility?

- An incorrect IP address on the computer may cause this error. Check the IP address and run the NI-USRP Configuration Utility again.
- An old FPGA or firmware image on the device may also cause this error. Upgrade the FPGA and firmware using the NI-USRP Configuration Utility.

Should I Update Device Firmware and FPGA Images?

Your device ships with firmware and FPGA images compatible with the NI-USRP driver software. You may need to update the device for compatibility with the latest version of the software.

The driver software media also includes the NI-USRP Configuration Utility, which you can use to update the devices.

Why Do I Receive an Enumeration Error?

If you are using a desktop computer with the NI-USRP instrument driver installed, it is possible that there is a compatibility issue between your computer and the PCIe card. Complete the following steps to confirm this issue and resolve it.

1. Navigate to **Start»Device Manager** to confirm the issue by verifying that **PCI Data Acquisition and Signal Processing Device/Controller** appears in Device Manager and that your USRP RIO device does not.

If you cannot confirm this, then the issue is not likely caused by a compatibility problem between your computer and the PCIe card. Contact NI or visit ni.com/support

2. Install the latest BIOS Compatibility software.
3. Restart your computer.
4. Complete the steps appropriate for your installed ADE in [Verifying the Device Connection](#). Repeat step 1 and observe if the outcome has changed. If you still receive an Enumeration Error, continue to step 5.
5. Power off your computer and remove the MXI card.
6. Toggle switch 1.
7. Reinstall the MXI card and power on your computer.
8. Repeat step 4. If nothing has changed, continue to step 7.
9. Uninstall the BIOS Compatibility software. Restart your computer.
10. Repeat step 4.

If trouble persists, contact NI or visit ni.com/support.

Why Don't NI-USRP Examples Appear in the NI Example Finder in LabVIEW?

NI-USRP does not install examples into the NI Example Finder.

Related Information

[NI-USRP Examples, Lessons, and Sample Projects](#) on page 11

Front Panels, Back Panels, and Connectors

Direct Connections to the Device

The USRP RIO device is a precision RF instrument that is sensitive to ESD and transients. Ensure you take the following precautions when making direct connections to the USRP RIO device to avoid damaging the device.



Notice Apply external signals only while the USRP RIO device is powered on. Applying external signals while the device is powered off may cause damage.

- Ensure you are properly grounded when manipulating cables or antennas connected to the USRP RIO device TX 1 RX 1, RX 1, or RX 2 connector.
- If you are using nonisolated devices, such as a nonisolated RF antenna, ensure the devices are maintained in a static-free environment.
- If you are using an active device, such as a preamplifier or switch routed to the USRP RIO device TX 1 RX 1, RX 1, or RX 2 connector, ensure that the device cannot generate signal transients greater than the RF and DC specifications of the USRP RIO device TX 1 RX 1, RX 1, or RX 2 connector.

USRP-2940 Front Panel, Back Panel, and LEDs

Front Panel

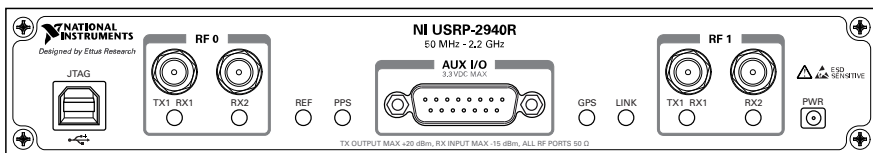

Table 2. Connector Descriptions

Pin		Description
JTAG		A USB port that connects the host computer to the device FPGA for development and debugging. LabVIEW FPGA does not currently support configuring or programming the device FPGA using the JTAG connector.
RF 0	TX1 RX1	Input and output terminal for the RF signal. TX1 RX1 is an SMA (f) connector with an impedance of 50 Ω and is a single-ended input or output channel.
	RX2	Input terminal for the RF signal. RX2 is an SMA (f) connector with an impedance of 50 Ω and is a single-ended input channel.
AUX I/O		General-purpose I/O (GPIO) port. AUX I/O is controlled by the FPGA.
RF 1	TX1 RX1	Input and output terminal for the RF signal. TX1 RX1 is an SMA (f) connector with an impedance of 50 Ω and is a single-ended input or output channel.
	RX2	Input terminal for the RF signal. RX2 is an SMA (f) connector with an impedance of 50 Ω and is a single-ended input channel.

The LED indications described in the following table occur only when you use the NI-USRP API with the default FPGA image. When you use LabVIEW FPGA, you customize the LED indications.

Table 3. LED Descriptions

Pin		Description	Color	Indication
RF 0	TX1 RX1	Indicates the transmit status of the device.	Off	The device is not active.
			Green	The device is transmitting data.
			Red	The device is not transmitting data.
	RX2	Indicates the receive status of the device.	Off	The device is not receiving data.
Green			The device is receiving data.	

Table 3. LED Descriptions (Continued)

Pin		Description	Color	Indication
REF		Indicates the status of the reference signal.	Off	There is no reference signal, or the device is not locked to the reference signal.
			Green	Blinking—The device is not locked to the reference signal. Solid—The device is locked to the reference signal.
PPS		Indicates the pulse per second (PPS).	Off	There is no reference signal, or the device is not locked to the reference signal.
			Green	Blinking—The device is not locked to the reference signal. Solid—The device is locked to the reference signal.
GPS		Indicates whether the GPSDO is locked.	Off	There is no GPSDO , or the device or the GPS is not locked.
			Green	The GPSDO is locked.
LINK		Indicates the status of the link to a host computer.	Off	There is no link to a host computer.
			Green/ Yellow/ Red	The host is actively communicating with the device.
RF 1	TX1 RX1	Indicates the transmit status of the device.	Off	The device is not active.
			Green	The device is transmitting data.
			Red	The device is not transmitting data.
	RX2	Indicates the receive status of the device.	Off	The device is not receiving data.
			Green	The device is receiving data.

Back Panel

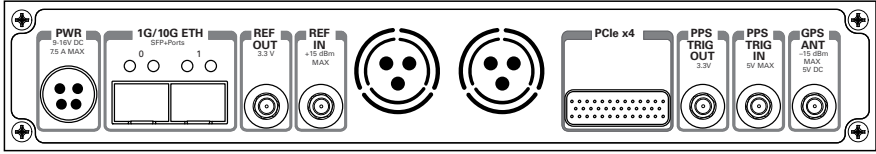



Table 4. Connector Descriptions

Connector	Description
PWR	Input that accepts a 9 V to 16 V, 6 A external DC power connector.
1G/10G ETH	Ethernet port that accepts 1G SFP modules and 10G SFP+ modules. With a 1G ETH module inserted, the ports accept gigabit Ethernet-compatible cables (Category 5, Category 5e, or Category 6).
REF OUT	Output terminal for an external reference signal for the LO on the device. REF OUT is a female SMA connector with an impedance of 50 Ω , and it is a single-ended reference output. The output signal at this connector is 10 MHz at 3.3 V.
REF IN	Input terminal for an external reference signal for the LO on the device. REF IN is a female SMA connector with an impedance of 50 Ω , and it is a single-ended reference input. REF IN accepts a 10 MHz signal with a minimum input power of 0 dBm (0.632 V _{pk-pk}) and a maximum input power of 15 dBm (3.56 V _{pk-pk}) for a square wave or sine wave.
PCIe x4	Port for a PCI Express Generation 1, x4 bus connection through an MXI Express four-lane cable.
PPS TRIG OUT	Output terminal for the pulse per second (PPS) timing reference. PPS TRIG OUT is a female SMA connector with an impedance of 50 Ω , and it is a single-ended input. The output signal is 0 V to 3.3 V TTL. You can also use this port as triggered output (TRIG OUT) that you program with the PPS Trig Out I/O signal.

Table 4. Connector Descriptions (Continued)

Connector	Description
PPS TRIG IN	Input terminal for pulse per second (PPS) timing reference. PPS TRIG IN is a female SMA connector with an impedance of 50 Ω, and it is a single-ended input channel. PPS TRIG IN accepts 0 V to 3.3 V TTL and 0 V to 5 V TTL signals. You can also use this port as a triggered input (TRIG IN) that you control using NI-USRP software.
GPS ANT	Input terminal for the GPS antenna signal. GPS ANT is a female SMA connector with a maximum input power of 15 dBm and an output of DC 5 V to power an active antenna.  Notice Do not terminate the GPS ANT port if you do not use it.

USRP-2942 Front Panel, Back Panel, and LEDs

Front Panel

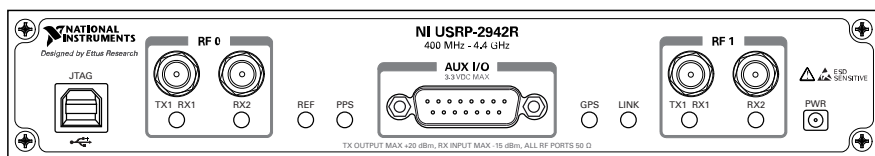

Table 5. Connector Descriptions

Pin	Description	
JTAG	A USB port that connects the host computer to the device FPGA for development and debugging. LabVIEW FPGA does not currently support configuring or programming the device FPGA using the JTAG connector.	
RF 0	TX1 RX1	Input and output terminal for the RF signal. TX1 RX1 is an SMA (f) connector with an impedance of 50 Ω and is a single-ended input or output channel.
	RX2	Input terminal for the RF signal. RX2 is an SMA (f) connector with an impedance of 50 Ω and is a single-ended input channel.
AUX I/O	General-purpose I/O (GPIO) port. AUX I/O is controlled by the FPGA.	

Table 5. Connector Descriptions (Continued)

Pin		Description
RF 1	TX1 RX1	Input and output terminal for the RF signal. TX1 RX1 is an SMA (f) connector with an impedance of 50 Ω and is a single-ended input or output channel.
	RX2	Input terminal for the RF signal. RX2 is an SMA (f) connector with an impedance of 50 Ω and is a single-ended input channel.



Note The LED indications described in the following table occur only when you use the NI-USRP API with the default FPGA image. When you use LabVIEW FPGA, you customize the LED indications.

Table 6. LED Descriptions

Pin		Description	Color	Indication
RF 0	TX1 RX1	Indicates the transmit status of the device.	Off	The device is not active.
			Green	The device is transmitting data.
			Red	The device is receiving data.
	RX2	Indicates the receive status of the device.	Off	The device is not receiving data.
			Green	The device is receiving data.
REF		Indicates the status of the reference signal.	Off	There is no reference signal, or the device is not locked to a reference signal.
			Green	Blinking—The device is not locked to the reference signal. Solid—The device is locked to the reference signal.
PPS		Indicates the pulse per second (PPS).	Off	There is no reference signal, or the device is not locked to the reference signal.
			Green	Blinking—The device is not locked to the reference signal. Solid—The device is locked to the reference signal.

Table 6. LED Descriptions (Continued)

Pin		Description	Color	Indication
GPS		Indicates whether the GPSDO is locked.	Off	There is no GPSDO, or the device or the GPS is not locked.
			Green	The GPSDO is locked.
LINK		Indicates the status of the link to a host computer.	Off	There is no link to a host computer.
			Green/ Yellow/ Red	The host is actively communicating with the device.
RF 1	TX1 RX1	Indicates the transmit status of the device.	Off	The device is not active.
			Red	The device is receiving data.
			Green	The device is transmitting data.
	RX2	Indicates the receive status of the device.	Off	The device is not receiving data.
			Green	The device is receiving data.

Back Panel

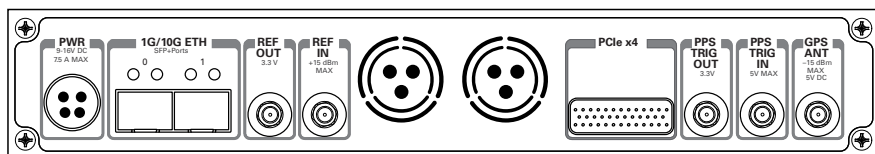



Table 7. Connector Descriptions

Connector	Description
PWR	Input that accepts a 9 V to 16 V, 6 A external DC power connector.
1G/10G ETH	Ethernet port that accepts 1G SFP modules and 10G SFP+ modules. With a 1G ETH module inserted, the ports accept gigabit Ethernet-compatible cables (Category 5, Category 5e, or Category 6).

Table 7. Connector Descriptions (Continued)

Connector	Description
REF OUT	Output terminal for an external reference signal for the LO on the device. REF OUT is a female SMA connector with an impedance of 50 Ω, and it is a single-ended reference output. The output signal at this connector is 10 MHz at 3.3 V.
REF IN	Input terminal for an external reference signal for the LO on the device. REF IN is a female SMA connector with an impedance of 50 Ω, and it is a single-ended reference input. REF IN accepts a 10 MHz signal with a minimum input power of 0 dBm (0.632 V _{pk-pk}) and a maximum input power of 15 dBm (3.56 V _{pk-pk}) for a square wave or sine wave.
PCIe x4	Port for a PCI Express Generation 1, x4 bus connection through an MXI Express four-lane cable.
PPS TRIG IN	Input terminal for pulse per second (PPS) timing reference. PPS TRIG IN is a female SMA connector with an impedance of 50 Ω, and it is a single-ended input channel. PPS TRIG IN accepts 0 V to 3.3 V TTL and 0 V to 5 V TTL signals. You can also use this port as a triggered input (TRIG IN) that you control using NI-USRP software.
PPS TRIG OUT	Output terminal for the pulse per second (PPS) timing reference. PPS TRIG OUT is a female SMA connector with an impedance of 50 Ω, and it is a single-ended input. The output signal is 0 V to 3.3 V TTL. You can also use this port as triggered output (TRIG OUT) that you program with the PPS Trig Out I/O signal.
GPS ANT	<p>Input terminal for the GPS antenna signal. GPS ANT is a female SMA connector with a maximum input power of 15 dBm and an output of DC 5 V to power an active antenna.</p> <p> Notice Do not terminate the GPS ANT port if you do not use it.</p>

USRP-2943 Front Panel, Back Panel, and LEDs

Front Panel

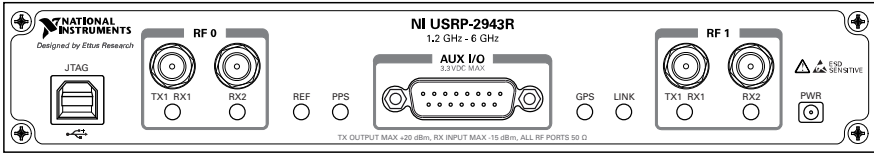

Table 8. Connector Descriptions

Pin		Description
JTAG		A USB port that connects the host computer to the device FPGA for development and debugging. LabVIEW FPGA does not currently support configuring or programming the device FPGA using the JTAG connector.
RF 0	TX1 RX1	Input and output terminal for the RF signal. TX1 RX1 is an SMA (f) connector with an impedance of 50 Ω and is a single-ended input or output channel.
	RX2	Input terminal for the RF signal. RX2 is an SMA (f) connector with an impedance of 50 Ω and is a single-ended input channel.
AUX I/O		General-purpose I/O (GPIO) port. AUX I/O is controlled by the FPGA.
RF 1	TX1 RX1	Input and output terminal for the RF signal. TX1 RX1 is an SMA (f) connector with an impedance of 50 Ω and is a single-ended input or output channel.
	RX2	Input terminal for the RF signal. RX2 is an SMA (f) connector with an impedance of 50 Ω and is a single-ended input channel.

The LED indications described in the following table occur only when you use the NI-USRP API with the default FPGA image. When you use LabVIEW FPGA, you customize the LED indications.

Table 9. LED Descriptions

Pin		Description	Color	Indication
RF 0	TX1 RX1	Indicates the transmit status of the device.	Off	The device is not active.
			Red	The device is receiving data.
			Green	The device is transmitting data.
	RX2	Indicates the receive status of the device.	Off	The device is not receiving data.
			Green	The device is receiving data.
REF		Indicates the status of the reference signal.	Off	There is no reference signal, or the device is not locked to the reference signal.
			Green	Blinking—The device is not locked to the reference signal. Solid—The device is locked to the reference signal.
PPS		Indicates the pulse per second (PPS).	Off	There is no reference signal, or the device is not locked to the reference signal.
			Green	Blinking—The device is not locked to the reference signal. Solid—The device is locked to the reference signal.
GPS		Indicates whether the GPSDO is locked.	Off	There is no GPSDO, or the device or the GPS is not locked.
			Green	The GPSDO is locked.
LINK		Indicates the status of the link to a host computer.	Off	There is no link to a host computer.
			Green/ Yellow/ Red	The host is actively communicating with the device.

Table 9. LED Descriptions (Continued)

Pin		Description	Color	Indication
RF 1	TX1 RX1	Indicates the transmit status of the device.	Off	The device is not active.
			Red	The device is receiving data.
			Green	The device is transmitting data.
	RX2	Indicates the receive status of the device.	Off	The device is not receiving data.
			Green	The device is receiving data.

Back Panel

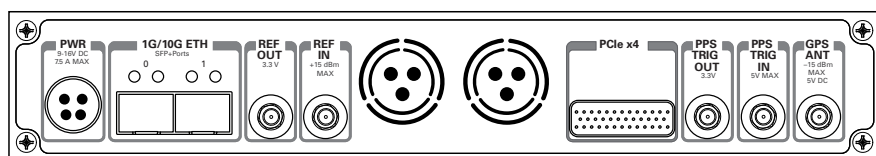



Table 10. Connector Descriptions

Connector	Description
PWR	Input that accepts a 9 V to 16 V, 6 A external DC power connector.
1G/10G ETH	Ethernet port that accepts 1G SFP modules and 10G SFP+ modules. With a 1G ETH module inserted, the ports accept gigabit Ethernet-compatible cables (Category 5, Category 5e, or Category 6).
REF OUT	Output terminal for an external reference signal for the LO on the device. REF OUT is a female SMA connector with an impedance of 50 Ω , and it is a single-ended reference output. The output signal at this connector is 10 MHz at 3.3 V.
REF IN	Input terminal for an external reference signal for the LO on the device. REF IN is a female SMA connector with an impedance of 50 Ω , and it is a single-ended reference input. REF IN accepts a 10 MHz signal with a minimum input power of 0 dBm (0.632 V _{pk-pk}) and a maximum input power of 15 dBm (3.56 V _{pk-pk}) for a square wave or sine wave.
PCIe x4	Port for a PCI Express Generation 1, x4 bus connection through an MXI Express four-lane cable.

Table 10. Connector Descriptions (Continued)

Connector	Description
PPS TRIG OUT	Output terminal for the pulse per second (PPS) timing reference. PPS TRIG OUT is a female SMA connector with an impedance of 50 Ω, and it is a single-ended input. The output signal is 0 V to 3.3 V TTL. You can also use this port as triggered output (TRIG OUT) that you program with the PPS Trig Out I/O signal.
PPS TRIG IN	Input terminal for pulse per second (PPS) timing reference. PPS TRIG IN is a female SMA connector with an impedance of 50 Ω, and it is a single-ended input channel. PPS TRIG IN accepts 0 V to 3.3 V TTL and 0 V to 5 V TTL signals. You can also use this port as a triggered input (TRIG IN) that you control using NI-USRP software.
GPS ANT	Input terminal for the GPS antenna signal. GPS ANT is an SMA (f) connector with a maximum input power of -15 dBm and an output of DC 5 V to power an active antenna.  Notice Do not terminate the GPS ANT port if you do not use it.

USRP-2944 Front Panel, Back Panel, and LEDs

Front Panel

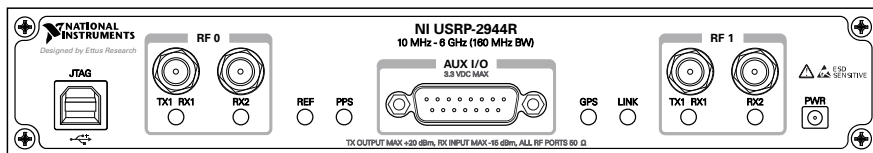

Table 11. Connector Descriptions

Connector		Use
JTAG		A USB port that connects the host computer to the device FPGA for recovery purposes. This port can be used with the Xilinx iMPACT configuration tool to temporarily load a new bitfile.
RF 0	TX1 RX1	Input and output terminal for the RF signal. TX1 RX1 is an SMA (f) connector with an impedance of 50 Ω and is a single-ended input or output channel.
	RX2	Input terminal for the RF signal. RX2 is an SMA (f) connector with an impedance of 50 Ω and is a single-ended input channel.
AUX I/O		General-purpose I/O (GPIO) port. AUX I/O is controlled by the FPGA.
RF 1	TX1 RX1	Input and output terminal for the RF signal. TX1 RX1 is an SMA (f) connector with an impedance of 50 Ω and is a single-ended input or output channel.
	RX2	Input terminal for the RF signal. RX2 is an SMA (f) connector with an impedance of 50 Ω and is a single-ended input channel.

Table 12. LED Indicators

LED		Description	Color	State	Indication
RF 0	TX1 RX1	Indicates the transmit status of the device.	OFF	—	The device is not active.
			Red	Solid	The device is transmitting data.
			Green	Solid	The device is receiving data.
	RX2	Indicates the receive status of the device.	OFF	—	The device is not receiving data.
Green			Solid	The device is receiving data.	

Table 12. LED Indicators (Continued)

LED		Description	Color	State	Indication
REF		Indicates the status of the reference signal.	OFF	—	There is no reference signal, or the device is not locked to the reference signal.
			Green	Blinking	The device is not locked to the reference signal.
				Solid	The device is locked to the reference signal.
PPS		Indicates the pulse per second (PPS).	OFF	—	There is no PPS timing reference signal, or the device is not locked to the reference signal.
			Green	Blinking	The device is locked to the PPS timing reference signal.
GPS		Indicates whether the GPSDO is locked.	OFF	—	There is no GPSDO or the GPSDO is not locked.
			Green	Solid	The GPSDO is locked.
LINK		Indicates the status of the link to a host computer.	OFF	—	There is no link to a host computer.
			Green, yellow, or red	Solid	The host is actively communicating with the device.
RF 1	TX1 RX1	Indicates the transmit status of the device.	OFF	—	The device is not active.
			Red	Solid	The device is transmitting data.
			Green	Solid	The device is receiving data.
	RX2	Indicates the receive status of the device.	OFF	—	The device is not receiving data.
			Green	Solid	The device is receiving data.

Back Panel

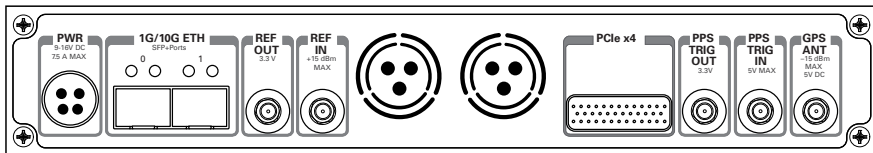



Table 13. Connector Descriptions

Connector	Use
PWR	Input that accepts a 9 V to 16 V, 6 A external DC power connector.
1G/10G ETH	Two SFP+ input terminals used for 1G ETH or 10G ETH connectivity with the host driver. Not currently supported in LabVIEW FPGA.
REF OUT	Output terminal for an external reference signal for the LO on the device. REF OUT is a female SMA connector with an impedance of 50 Ω , and it is a single-ended reference output. The output signal at this connector is 10 MHz at 3.3 V.
REF IN	Input terminal for an external reference signal for the LO on the device. REF IN is a female SMA connector with an impedance of 50 Ω , and it is a single-ended reference input. REF IN accepts a 10 MHz signal with a minimum input power of 0 dBm (0.632 Vpk-pk) and a maximum input power of 15 dBm (3.56 Vpk-pk) for a square wave or sine wave.
PCIe x4	Port for a PCI Express Generation 1, x4 bus connection through an MXI Express four-lane cable.
PPS TRIG OUT	Output terminal for the pulse per second (PPS) timing reference. PPS TRIG OUT is a female SMA connector with an impedance of 50 Ω , and it is a single-ended input. The output signal is 0 V to 3.3 V TTL. You can also use this port as triggered output (TRIG OUT) that you program with the PPS Trig Out I/O signal.

Table 13. Connector Descriptions (Continued)

Connector	Use
PPS TRIG IN	Input terminal for pulse per second (PPS) timing reference. PPS TRIG IN is a female SMA connector with an impedance of 50 Ω, and it is a single-ended input channel. PPS TRIG IN accepts 0 V to 3.3 V TTL and 0 V to 5 V TTL signals. You can also use this port as a triggered input (TRIG IN) that you control using NI-USRP software.
GPS ANT	Input terminal for the GPS antenna signal. GPS ANT is a female SMA connector with a maximum input power of -15 dBm and an output of DC 5 V to power an active antenna.  Notice Do not terminate the GPS ANT port if you do not use it.

USRP-2945 Front Panel, Back Panel, and LEDs

Front Panel

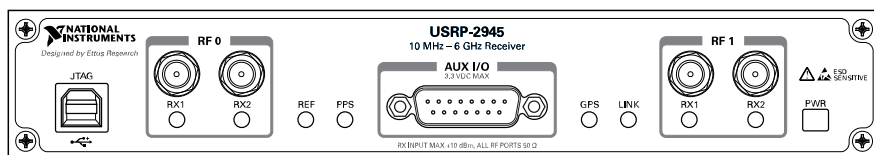

Table 14. Connector Descriptions

Connector	Use				
JTAG	A USB port that connects the host computer to the device FPGA for recovery purposes. This port can be used with the Xilinx iMPACT configuration tool to temporarily load a new bitfile.				
RF 0	<table border="1"> <tr> <td>RX1</td> <td>Input terminal for the RF signal. RX1 is an SMA (f) connector with an impedance of 50 Ω and is a single-ended input channel.</td> </tr> <tr> <td>RX2</td> <td>Input terminal for the RF signal. RX2 is an SMA (f) connector with an impedance of 50 Ω and is a single-ended input channel.</td> </tr> </table>	RX1	Input terminal for the RF signal. RX1 is an SMA (f) connector with an impedance of 50 Ω and is a single-ended input channel.	RX2	Input terminal for the RF signal. RX2 is an SMA (f) connector with an impedance of 50 Ω and is a single-ended input channel.
RX1	Input terminal for the RF signal. RX1 is an SMA (f) connector with an impedance of 50 Ω and is a single-ended input channel.				
RX2	Input terminal for the RF signal. RX2 is an SMA (f) connector with an impedance of 50 Ω and is a single-ended input channel.				
AUX I/O	General-purpose I/O (GPIO) port. AUX I/O is controlled by the FPGA.				

Table 14. Connector Descriptions (Continued)

Connector		Use
RF 1	RX1	Input terminal for the RF signal. RX1 is an SMA (f) connector with an impedance of 50 Ω and is a single-ended input channel.
	RX2	Input terminal for the RF signal. RX2 is an SMA (f) connector with an impedance of 50 Ω and is a single-ended input channel.



Note The LED indications described in the following table occur only when you use the NI-USRP API with the default API image. When you use LabVIEW FPGA, you customize the LED indications.

Table 15. LED Indicators

LED	Description	Color	State	Indication
RF 0	RX1	OFF	—	The module is not receiving.
		Green	Solid	The module is receiving data.
	RX2	OFF	—	The module is not receiving.
		Green	Solid	The module is receiving.
REF	Indicates the status of the reference signal.	OFF	—	There is no reference signal, or the device is not locked to the reference signal.
		Green	Blinking	The device is not locked to the reference signal.
			Solid	The device is locked to the reference signal.
PPS	Indicates the pulse per second (PPS).	OFF	—	There is no PPS timing reference signal, or the device is not locked to the reference signal.
		Green	Blinking	The device is locked to the PPS timing reference signal.
GPS	Indicates whether the GPSDO is locked.	OFF	—	There is no GPSDO or the GPSDO is not locked.
		Green	Solid	The GPSDO is locked.

Table 15. LED Indicators (Continued)

LED		Description	Color	State	Indication
LINK		Indicates the status of the link to a host computer.	OFF	—	There is no link to a host computer.
			Green, yellow, or red	Solid	The host is actively communicating with the device.
RF 1	RX1	Indicates the receive status of the module.	OFF	—	The module is not active.
			Green	Solid	The module is receiving data.
	RX2	Indicates the receive status of the module.	OFF	—	The module is not receiving.
			Green	Solid	The module is receiving.

Back Panel

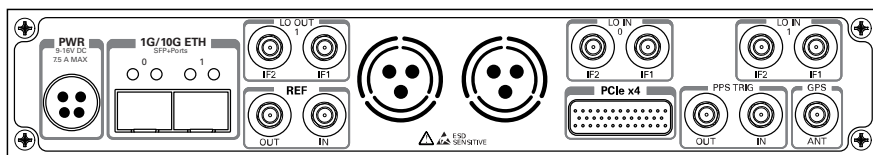



Table 16. Connector Descriptions

Connector	Use
PWR	Input that accepts a 9 V to 16 V, 6 A external DC power connector.
1G/10G ETH	Two SFP+ input terminals used for 1G ETH or 10G ETH connectivity with the host driver. Not currently supported in LabVIEW FPGA.
LO OUT 1 IF2	Output terminal for the IF LO signal exported by RF 1. LO OUT 1 IF2 is a female SMA connector with an impedance of 50 Ω.
LO OUT 1 IF1	Output terminal for the RF LO signal exported by RF 1. LO OUT 1 IF1 is a female SMA connector with an impedance of 50 Ω.
REF OUT	Output terminal for an external reference signal for the LO on the device. REF OUT is a female SMA connector with an impedance of 50 Ω, and it is a single-ended reference output. The output signal at this connector is 10 MHz at 3.3 V.

Table 16. Connector Descriptions (Continued)

Connector	Use
REF IN	Input terminal for an external reference signal for the LO on the device. REF IN is a female SMA connector with an impedance of 50 Ω , and it is a single-ended reference input. REF IN accepts a 10 MHz signal with a minimum input power of 0 dBm (0.632 V _{pk-pk}) and a maximum input power of 15 dBm (3.56 V _{pk-pk}) for a square wave or sine wave.
LO IN 0 IF2	Terminal for an external signal to the IF LO input on the RF 0 daughterboard. This signal can be used as the LO source for an RF 0 channel by selecting external on that channel's LO source setting. LO IN 0 IF2 is a female SMA connector with an impedance of 50 Ω .
LO IN 0 IF1	Terminal for an external signal to the IF LO input on the RF 0 daughterboard. This signal can be used as the LO source for an RF 0 channel by selecting external on that channel's LO source setting. LO IN 0 IF1 is a female SMA connector with an impedance of 50 Ω .
PCIe x4	Port for a PCI Express Generation 1, x4 bus connection through an MXI Express four-lane cable.
LO IN 1 IF2	Terminal for an external signal to the IF LO input on the RF 0 daughterboard. This signal can be used as the LO source for an RF 0 channel by selecting external on that channel's LO source setting. LO IN 1 IF2 is a female SMA connector with an impedance of 50 Ω .
LO IN 1 IF1	Terminal for an external signal to the IF LO input on the RF 0 daughterboard. This signal can be used as the LO source for an RF 0 channel by selecting external on that channel's LO source setting. LO IN 1 IF1 is a female SMA connector with an impedance of 50 Ω .
PPS TRIG OUT	Output terminal for the pulse per second (PPS) timing reference. PPS TRIG OUT is a female SMA connector with an impedance of 50 Ω , and it is a single-ended input. The output signal is 0 V to 3.3 V TTL. You can also use this port as triggered output (TRIG OUT) that you program with the PPS Trig Out I/O signal.

Table 16. Connector Descriptions (Continued)

Connector	Use
PPS TRIG IN	Input terminal for pulse per second (PPS) timing reference. PPS TRIG IN is a female SMA connector with an impedance of 50 Ω , and it is a single-ended input channel. PPS TRIG IN accepts 0 V to 3.3 V TTL and 0 V to 5 V TTL signals. You can also use this port as a triggered input (TRIG IN) that you control using NI-USRP.
GPS ANT	<p>Input terminal for the GPS antenna signal. GPS ANT is a female SMA connector with a maximum input power of -15 dBm and an output of DC 5 V to power an active antenna.</p> <p> Notice Do not terminate the GPS ANT port if you do not use it.</p>

GPIO Connector

Table 17. GPIO Connector Pin Assignments

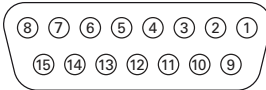
AUX I/O Connector	Pin	NI-USRP Terminal Name	USRP RIO (LV FPGA) IO Node Terminal Name
	1	3.3 V	3.3 V
	2	GPIO 0	AUX I/O 0
	3	GPIO 1	AUX I/O 1
	4	GPIO 2	AUX I/O 2
	5	GPIO 3	AUX I/O 3
	6	GPIO 4	AUX I/O 4
	7	GPIO 5	AUX I/O 5
	8	GPIO 6	AUX I/O 6
	9	GPIO 7	AUX I/O 7
	10	GPIO 8	AUX I/O 8
	11	GPIO 9	AUX I/O 9
	12	GPIO 10	AUX I/O 10
	13	GPIO 11	AUX I/O 11
	14	0 V	0 V
	15	0 V	0 V

Where to Go Next

Refer to the following figure for information about other product tasks and associated resources for those tasks.

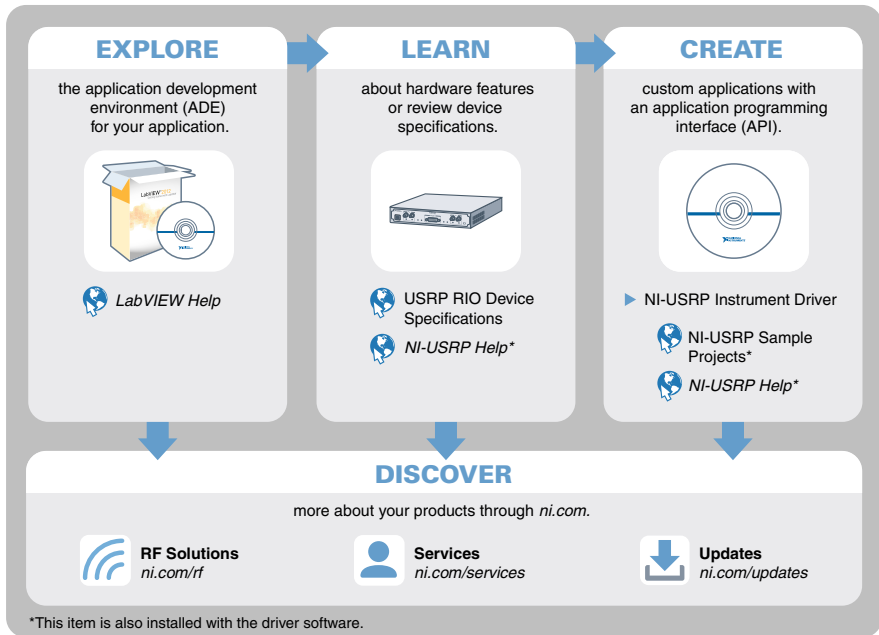

Worldwide Support and Services

The NI website is your complete resource for technical support. At [ni.com/support](#), you have access to everything from troubleshooting and application development self-help resources to email and phone assistance from NI Application Engineers.

Visit [ni.com/services](#) for information about the services NI offers.

Visit [ni.com/register](#) to register your NI product. Product registration facilitates technical support and ensures that you receive important information updates from NI.

NI corporate headquarters is located at 11500 North Mopac Expressway, Austin, Texas, 78759-3504. NI also has offices located around the world. For support in the United States, create your service request at [ni.com/support](#) or dial 1 866 ASK MYNI (275 6964). For support outside the United States, visit the *Worldwide Offices* section of [ni.com/niglobal](#) to access the branch office websites, which provide up-to-date contact information.

Information is subject to change without notice. Refer to the *NI Trademarks and Logo Guidelines* at ni.com/trademarks for information on NI trademarks. Other product and company names mentioned herein are trademarks or trade names of their respective companies. For patents covering NI products/technology, refer to the appropriate location: **Help»Patents** in your software, the `patents.txt` file on your media, or the *National Instruments Patent Notice* at ni.com/patents. You can find information about end-user license agreements (EULAs) and third-party legal notices in the `readme` file for your NI product. Refer to the *Export Compliance Information* at ni.com/legal/export-compliance for the NI global trade compliance policy and how to obtain relevant HTS codes, ECCNs, and other import/export data. NI MAKES NO EXPRESS OR IMPLIED WARRANTIES AS TO THE ACCURACY OF THE INFORMATION CONTAINED HEREIN AND SHALL NOT BE LIABLE FOR ANY ERRORS. U.S. Government Customers: The data contained in this manual was developed at private expense and is subject to the applicable limited rights and restricted data rights as set forth in FAR 52.227-14, DFAR 252.227-7014, and DFAR 252.227-7015.

© 2015—2019 National Instruments. All rights reserved.

375717J-01 December 19, 2019