

COMPREHENSIVE SERVICES

We offer competitive repair and calibration services, as well as easily accessible documentation and free downloadable resources.

SELL YOUR SURPLUS

We buy new, used, decommissioned, and surplus parts from every NI series. We work out the best solution to suit your individual needs.

 Sell For Cash  Get Credit  Receive a Trade-In Deal

OBSOLETE NI HARDWARE IN STOCK & READY TO SHIP

We stock **New**, **New Surplus**, **Refurbished**, and **Reconditioned** NI Hardware.



Bridging the gap between the manufacturer and your legacy test system.

 1-800-915-6216

 www.apexwaves.com

 sales@apexwaves.com

All trademarks, brands, and brand names are the property of their respective owners.

Request a Quote

 **CLICK HERE**

PS-14

Power Supply

NI PS-14 Power Supply User Manual

Worldwide Technical Support and Product Information

ni.com

Worldwide Offices

Visit ni.com/niglobal to access the branch office Web sites, which provide up-to-date contact information, support phone numbers, email addresses, and current events.

National Instruments Corporate Headquarters

11500 North Mopac Expressway Austin, Texas 78759-3504 USA Tel: 512 683 0100

For further support information, refer to the *Technical Support and Professional Services* appendix. To comment on National Instruments documentation, refer to the National Instruments Web site at ni.com/info and enter the Info Code `feedback`.

Legal Information

Warranty

NI devices are warranted against defects in materials and workmanship for a period of one year from the invoice date, as evidenced by receipts or other documentation. National Instruments will, at its option, repair or replace equipment that proves to be defective during the warranty period. This warranty includes parts and labor.

The media on which you receive National Instruments software are warranted not to fail to execute programming instructions, due to defects in materials and workmanship, for a period of 90 days from the invoice date, as evidenced by receipts or other documentation. National Instruments will, at its option, repair or replace software media that do not execute programming instructions if National Instruments receives notice of such defects during the warranty period. National Instruments does not warrant that the operation of the software shall be uninterrupted or error free.

A Return Material Authorization (RMA) number must be obtained from the factory and clearly marked on the outside of the package before any equipment will be accepted for warranty work. National Instruments will pay the shipping costs of returning to the owner parts which are covered by warranty.

National Instruments believes that the information in this document is accurate. The document has been carefully reviewed for technical accuracy. In the event that technical or typographical errors exist, National Instruments reserves the right to make changes to subsequent editions of this document without prior notice to holders of this edition. The reader should consult National Instruments if errors are suspected. In no event shall National Instruments be liable for any damages arising out of or related to this document or the information contained in it.

EXCEPT AS SPECIFIED HEREIN, NATIONAL INSTRUMENTS MAKES NO WARRANTIES, EXPRESS OR IMPLIED, AND SPECIFICALLY DISCLAIMS ANY WARRANTY OF MERCHANTABILITY OR FITNESS FOR A PARTICULAR PURPOSE. CUSTOMER'S RIGHT TO RECOVER DAMAGES CAUSED BY FAULT OR NEGLIGENCE ON THE PART OF NATIONAL INSTRUMENTS SHALL BE LIMITED TO THE AMOUNT THEREOF PAID BY THE CUSTOMER. NATIONAL INSTRUMENTS WILL NOT BE LIABLE FOR DAMAGES RESULTING FROM LOSS OF DATA, PROFITS, USE OF PRODUCTS, OR INCIDENTAL OR CONSEQUENTIAL DAMAGES, EVEN IF ADVISED OF THE POSSIBILITY THEREOF. This limitation of the liability of National Instruments will apply regardless of the form of action, whether in contract or tort, including negligence. Any action against National Instruments must be brought within one year after the cause of action accrues. National Instruments shall not be liable for any delay in performance due to causes beyond its reasonable control. The warranty provided herein does not cover damages, defects, malfunctions, or service failures caused by owner's failure to follow the National Instruments installation, operation, or maintenance instructions; owner's modification of the product; owner's abuse, misuse, or negligent acts; and power failure or surges, fire, flood, accident, actions of third parties, or other events outside reasonable control.

Copyright

Under the copyright laws, this publication may not be reproduced or transmitted in any form, electronic or mechanical, including photocopying, recording, storing in an information retrieval system, or translating, in whole or in part, without the prior written consent of National Instruments Corporation.

National Instruments respects the intellectual property of others, and we ask our users to do the same. NI software is protected by copyright and other intellectual property laws. Where NI software may be used to reproduce software or other materials belonging to others, you may use NI software only to reproduce materials that you may reproduce in accordance with the terms of any applicable license or other legal restriction.

End-User License Agreements and Third-Party Legal Notices

You can find end-user license agreements (EULAs) and third-party legal notices in the following locations:

- Notices are located in the <National Instruments>_Legal Information and <National Instruments> directories.
- EULAs are located in the <National Instruments>\Shared\MDF\Legal\license directory.
- Review <National Instruments>_Legal Information.txt for more information on including legal information in installers built with NI products.

Trademarks

Refer to the *NI Trademarks and Logo Guidelines* at ni.com/trademarks for more information on National Instruments trademarks.

ARM, Keil, and μ Vision are trademarks or registered of ARM Ltd or its subsidiaries.

LEGO, the LEGO logo, WEDO, and MINDSTORMS are trademarks of the LEGO Group. ©2013 The LEGO Group.

TETRIX by Pitsco is a trademark of Pitsco, Inc. ©2013

FIELDBUS FOUNDATION™ and FOUNDATION™ are trademarks of the Fieldbus Foundation.

EtherCAT® is a registered trademark of and licensed by Beckhoff Automation GmbH.

CANopen® is a registered Community Trademark of CAN in Automation e.V.

DeviceNet™ and EtherNet/IP™ are trademarks of ODVA.

Go!, SensorDAQ, and Vernier are registered trademarks of Vernier Software & Technology. Vernier Software & Technology and vernier.com are trademarks or trade dress.

Xilinx is the registered trademark of Xilinx, Inc.

Taprite and Trilobular are registered trademarks of Research Engineering & Manufacturing Inc.

FireWire® is the registered trademark of Apple Inc.

Linux® is the registered trademark of Linus Torvalds in the U.S. and other countries.

Handle Graphics®, MATLAB®, Real-Time Workshop®, Simulink®, Stateflow®, and xPC TargetBox® are registered trademarks, and TargetBox™ and Target Language Compiler™ are trademarks of The MathWorks, Inc.

Tektronix®, Tek, and Tektronix, Enabling Technology are registered trademarks of Tektronix, Inc.

The Bluetooth® word mark is a registered trademark owned by the Bluetooth SIG, Inc.

The ExpressCard™ word mark and logos are owned by PCMCIA and any use of such marks by National Instruments is under license.

The mark LabWindows is used under a license from Microsoft Corporation. Windows is a registered trademark of Microsoft Corporation in the United States and other countries.

Other product and company names mentioned herein are trademarks or trade names of their respective companies.

Members of the National Instruments Alliance Partner Program are business entities independent from National Instruments and have no agency, partnership, or joint-venture relationship with National Instruments.

Patents

For patents covering National Instruments products/technology, refer to the appropriate location: **Help»Patents** in your software, the `patents.txt` file on your media, or the *National Instruments Patent Notice* at ni.com/patents.

Export Compliance Information

Refer to the *Export Compliance Information* at ni.com/legal/export-compliance for the National Instruments global trade compliance policy and how to obtain relevant HTS codes, ECCNs, and other import/export data.

WARNING REGARDING USE OF NATIONAL INSTRUMENTS PRODUCTS

(1) NATIONAL INSTRUMENTS PRODUCTS ARE NOT DESIGNED WITH COMPONENTS AND TESTING FOR A LEVEL OF RELIABILITY SUITABLE FOR USE IN OR IN CONNECTION WITH SURGICAL IMPLANTS OR AS CRITICAL COMPONENTS IN ANY LIFE SUPPORT SYSTEMS WHOSE FAILURE TO PERFORM CAN REASONABLY BE EXPECTED TO CAUSE SIGNIFICANT INJURY TO A HUMAN.

(2) IN ANY APPLICATION, INCLUDING THE ABOVE, RELIABILITY OF OPERATION OF THE SOFTWARE PRODUCTS CAN BE IMPAIRED BY ADVERSE FACTORS, INCLUDING BUT NOT LIMITED TO FLUCTUATIONS IN ELECTRICAL POWER SUPPLY, COMPUTER HARDWARE MALFUNCTIONS, COMPUTER OPERATING SYSTEM SOFTWARE FITNESS, FITNESS OF COMPILERS AND DEVELOPMENT SOFTWARE USED TO DEVELOP AN APPLICATION, INSTALLATION ERRORS, SOFTWARE AND HARDWARE COMPATIBILITY PROBLEMS, MALFUNCTIONS OR FAILURES OF ELECTRONIC MONITORING OR CONTROL DEVICES, TRANSIENT FAILURES OF ELECTRONIC SYSTEMS (HARDWARE AND/OR SOFTWARE), UNANTICIPATED USES OR MISUSES, OR ERRORS ON THE PART OF THE USER OR APPLICATIONS DESIGNER (ADVERSE FACTORS SUCH AS THESE ARE HEREAFTER COLLECTIVELY TERMED "SYSTEM FAILURES"). ANY APPLICATION WHERE A SYSTEM FAILURE WOULD CREATE A RISK OF HARM TO PROPERTY OR PERSONS (INCLUDING THE RISK OF BODILY INJURY AND DEATH) SHOULD NOT BE RELIANT SOLELY UPON ONE FORM OF ELECTRONIC SYSTEM DUE TO THE RISK OF SYSTEM FAILURE. TO AVOID DAMAGE, INJURY, OR DEATH, THE USER OR APPLICATION DESIGNER MUST TAKE REASONABLY PRUDENT STEPS TO PROTECT AGAINST SYSTEM FAILURES, INCLUDING BUT NOT LIMITED TO BACK-UP OR SHUT DOWN MECHANISMS. BECAUSE EACH END-USER SYSTEM IS CUSTOMIZED AND DIFFERS FROM NATIONAL INSTRUMENTS' TESTING PLATFORMS AND BECAUSE A USER OR APPLICATION DESIGNER MAY USE NATIONAL INSTRUMENTS PRODUCTS IN COMBINATION WITH OTHER PRODUCTS IN A MANNER NOT EVALUATED OR CONTEMPLATED BY NATIONAL INSTRUMENTS, THE USER OR APPLICATION DESIGNER IS ULTIMATELY RESPONSIBLE FOR VERIFYING AND VALIDATING THE SUITABILITY OF NATIONAL INSTRUMENTS PRODUCTS WHENEVER NATIONAL INSTRUMENTS PRODUCTS ARE INCORPORATED IN A SYSTEM OR APPLICATION, INCLUDING, WITHOUT LIMITATION, THE APPROPRIATE DESIGN, PROCESS AND SAFETY LEVEL OF SUCH SYSTEM OR APPLICATION.

Compliance

Electromagnetic Compatibility Information

This hardware has been tested and found to comply with the applicable regulatory requirements and limits for electromagnetic compatibility (EMC) as indicated in the hardware's Declaration of Conformity (DoC)¹. These requirements and limits are designed to provide reasonable protection against harmful interference when the hardware is operated in the intended electromagnetic environment. In special cases, for example when either highly sensitive or noisy hardware is being used in close proximity, additional mitigation measures may have to be employed to minimize the potential for electromagnetic interference.

While this hardware is compliant with the applicable regulatory EMC requirements, there is no guarantee that interference will not occur in a particular installation. To minimize the potential for the hardware to cause interference to radio and television reception or to experience unacceptable performance degradation, install and use this hardware in strict accordance with the instructions in the hardware documentation and the DoC¹.

If this hardware does cause interference with licensed radio communications services or other nearby electronics, which can be determined by turning the hardware off and on, you are encouraged to try to correct the interference by one or more of the following measures:

- Reorient the antenna of the receiver (the device suffering interference).
- Relocate the transmitter (the device generating interference) with respect to the receiver.
- Plug the transmitter into a different outlet so that the transmitter and the receiver are on different branch circuits.

Some hardware may require the use of a metal, shielded enclosure (windowless version) to meet the EMC requirements for special EMC environments such as, for marine use or in heavy industrial areas. Refer to the hardware's user documentation and the DoC¹ for product installation requirements.

When the hardware is connected to a test object or to test leads, the system may become more sensitive to disturbances or may cause interference in the local electromagnetic environment.

Operation of this hardware in a residential area is likely to cause harmful interference. Users are required to correct the interference at their own expense or cease operation of the hardware.

Changes or modifications not expressly approved by National Instruments could void the user's right to operate the hardware under the local regulatory rules.

¹ The Declaration of Conformity (DoC) contains important EMC compliance information and instructions for the user or installer. To obtain the DoC for this product, visit ni.com/certification, search by model number or product line, and click the appropriate link in the Certification column.

Contents

About This Manual

Related Documentation	ix
-----------------------------	----

Chapter 1

Getting Started

Unpacking.....	1-1
What You Need to Get Started	1-1
Key Features	1-1
Power Supply Description	1-2
Output Terminals.....	1-3
Output Voltage Potentiometer	1-3
DC On LED	1-4
Input Terminals.....	1-4
Mounting Equipment.....	1-4
Side Mounting Kit	1-4
Panel Mounting Kit	1-4

Chapter 2

Installation and Configuration

Mounting Orientation and Installation	2-1
Wiring The Terminals	2-3
Operating the NI PS-14	2-4
Serial Operation	2-4
Parallel Operation	2-4
Two-Phase Power Operation	2-5
External Input Protection.....	2-6
Operation in a Sealed Enclosure.....	2-6
Cooling	2-7
Hazardous Risks	2-7
Service Parts	2-7
Peak Current Capability.....	2-7
Charging Batteries	2-8
Back Feeding Loads	2-8
Output Circuit Breakers.....	2-8
Inductive and Capacitive Loads	2-10

Appendix A Specifications

Dimensions and Weight.....	A-1
AC Input	A-2
DC Input	A-4
Input Current Inrush Surge	A-5
Hold-up Time.....	A-6
Output	A-7
Peak Current Capability.....	A-8
Efficiency and Power Losses.....	A-8
Reliability.....	A-9
Dielectric Strength	A-10
Used Substances	A-11
Environment.....	A-12
Protection Features	A-13

Appendix B Technical Support and Professional Services

Index

About This Manual

The *NI PS-14 Power Supply User Manual* describes the features and specifications of the NI PS-14 power supply and contains information about installing the power supply.

Related Documentation

The following documents contain information that you might find helpful as you read this manual:

- *NI PS-14/15/16/17 Side Mount Brackets Installation Guide*
- *NI PS-14/15/16/17 Panel Mount Brackets Installation Guide*
- *NI PS-14/15/16/17 Instruction Manual*

Getting Started

This chapter describes the key features of the NI PS-14 power supply and lists the kit contents and mounting equipment you can order from National Instruments.

Unpacking

Carefully inspect the shipping container and the power supply for damage. Check for visible damage to the metal work. If damage appears to have been caused during shipment, file a claim with the carrier. Retain the packing material for possible inspection and/or reshipment.

What You Need to Get Started

The NI PS-14 power supply kit contains the following items:

- NI PS-14 power supply
- Printed *NI PS-14 Instruction Manual*

Key Features

The NI PS-14 has a short-term power capability of 150% and built-in large sized output capacitors to help start motors, charge capacitors and absorb reverse energy. A wide range input voltage design and a negligible low input inrush current make installation and usage simple.

The key features of the NI PS-14 power supply include the following:

- Wide-range 100 to 240 V input
- Small size—Power supply width of only 32 mm
- High efficiency—efficiency up to 89.8%
- 150% peak load capability
- DC input from 110 to 300 V_{DC}
- Active power factor correction (PFC)



Caution Must be mounted in an enclosure by qualified personnel.

This power supply is designed for installation in an enclosure and is intended for general use, such as in industrial control, office, communication, and instrumentation equipment. Do not use this device in aircraft, trains and nuclear equipment, where malfunctioning of the power supply may cause severe personal injury or threaten human life. For more information, refer to Appendix A, *Specifications*.

Power Supply Description

Figures 1-1 and 1-2 show the functional description and front panel features of the NI PS-14 power supply.

Figure 1-1 provides the functional diagram for the NI PS-14.

Figure 1-1. Functional Diagram for the NI PS-14 Power Supply

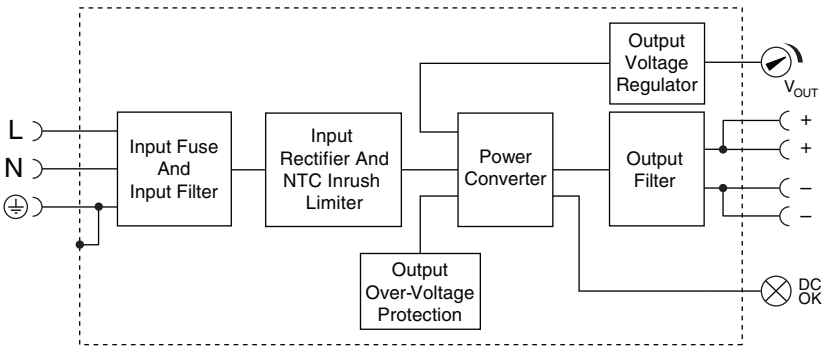
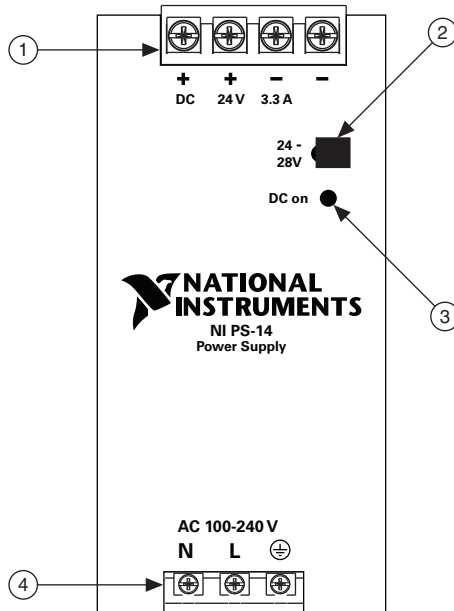

Figure 1-2 provides the front panel features of the NI PS-14.

Figure 1-2. Front View of the NI PS-14 Power Supply



- | | |
|--------------------------------------|-------------------------------------|
| 1 Output Terminals (Screw Terminals) | 3 DC on LED |
| 2 Output Voltage Potentiometer | 4 Input Terminals (Screw Terminals) |

Output Terminals

The NI PS-14 has a total of four output terminals, providing two positive (+) output terminals and two negative (-) output terminals. Both positive terminals are wired together internally, and both negative terminals are wired together internally, as shown in Figure 1-1. The output terminals provide 24 V_{DC} with 3.3 A of current.

Output Voltage Potentiometer



Note You must open the protective flap to turn the potentiometer.

Output voltage from the NI PS-14 is set by the output voltage potentiometer, shown in Figure 1-2. The factory setting output voltage is 24.1 V \pm 0.2% (at full load when the power supply is cold), and the potentiometer allows the output voltage to be adjusted from 24-28 V on any unit. The output voltage may be adjusted above 28 V by the potentiometer, but voltages beyond 28 V are *not* guaranteed.



Note Output voltages greater than 28 V are not supported on an NI PS-14 unit.

DC On LED

This green LED indicates the status of available DC power through the output terminals. If the LED is lit, DC output of greater than 21 V is available for use through the output terminals. If the LED is not lit, DC is not currently available. The DC On LED is wired internally to the power conversion circuitry prior to the output filtering stage, as shown in Figure 1-1.

If the DC On LED does not light when power is provided through the input terminals, it may indicate a problem with the power supply. Contact National Instruments for more details.

Input Terminals



Caution National Instruments recommends that you wire all three input terminals for proper operation of the NI PS-14.

The NI PS-14 power supply derives power through the input terminals on the front panel, shown in Figure 1-2. There are three terminals corresponding to the Neutral input, the Line (or hot) input, and the Protective Earth (PE) input. The NI PS-14 rectifies both single-phase and two-phase AC input. The Neutral input terminal provides a MAINS return path for the input circuitry. The Line input is the primary power input for the supply. The PE input corresponds to an earth ground. As shown in Figure 1-1, the power supply case itself is grounded to the PE input.

Mounting Equipment

Contact National Instruments to order the following mounting options for the NI PS-14 power supply. Refer to Table 1-1 for part numbers.

Table 1-1. Mounting Equipment

Part Number	Mounting Kit
199429-01	SIDE MOUNTING KIT FOR NI PS-14/15
199432-01	PANEL MOUNTING KIT FOR NI PS-14/15/16/17

Side Mounting Kit

The Side Mounting Kit (199429-01) allows you to mount the NI PS-14 on its side to a wall, panel surface, or a DIN-Rail for reduced installation depth. Refer to the *NI PS-14/15/16/17 Side Mount Brackets Installation Guide* at ni.com for more information.

Panel Mounting Kit

The Panel Mounting Kit (199432-01) allows you to mount the NI PS-14 to a wall or panel surface without using a DIN-Rail. Refer to the *NI PS-14/15/16/17 Panel Mount Brackets Installation Guide* at ni.com for more information.

Installation and Configuration

This chapter describes how to prepare and operate the NI PS-14 power supply.

Mounting Orientation and Installation

This section describes the different mounting orientations, and the effect that mounting orientation has on power supply performance.

Mounting orientations other than input terminals on the bottom and output on the top require a reduction in continuous output power or a limitation in the maximum allowed ambient temperature. The amount of reduction influences the lifetime expectancy of the power supply. Therefore, two different derating curves for continuous operation are referenced in Figure 2-1:

- **Curve A1**—Recommended output current.
- **Curve A2**—Maximum allowed output current (which results in approximately half the lifetime expectancy for the power supply when following curve A1).



Note National Instruments recommends that the power supply be oriented such that the output terminals are located on top and the input terminals located on bottom. Figure 2-1 refers to this as the *Standard Orientation*.

Figure 2-1. NI PS-14 Mounting Orientations

Mounting Orientation A (Standard Orientation)

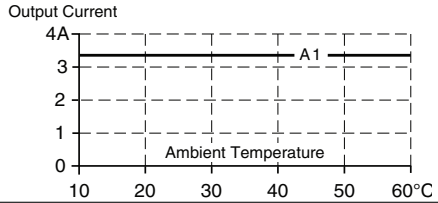
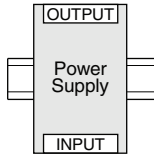

Mounting Orientation B (Upside Down)

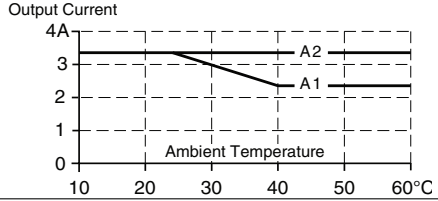
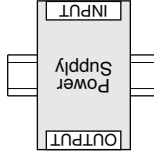

Mounting Orientation C (Table-top Mounting)

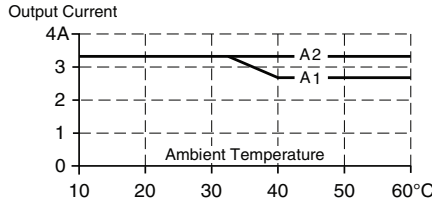
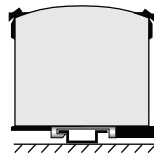

Mounting Orientation D (Horizontal ccw)

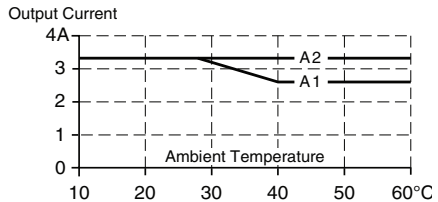
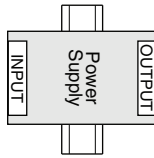

Mounting Orientation E (Horizontal ccw)

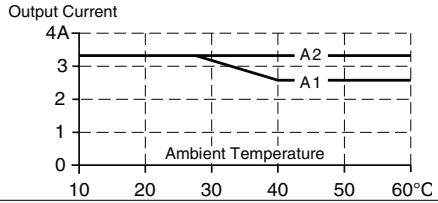
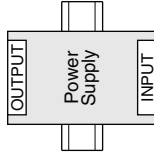

Mount the NI PS-14 power supply according to the installation instructions included with your mounting kit. For details on the mounting options available, refer to the [Mounting Equipment](#) section of Chapter 1, [Getting Started](#).

Wiring The Terminals

This section describes wiring for the NI PS-14 power supply. Table 2-1 provides a list of basic requirements for wiring.

Table 2-1. Wiring Requirements

Type	Screw Terminals
Solid wire	0.5 to 6 mm
Stranded wire	0.5 to 4 mm
American wire gauge	20 to 10 AWG
Ferrules	Allowed, but not required
Wire stripping length	7 mm (0.275 in.)
Screwdriver	3.5 mm slotted or Pozidrive No. 2
Recommended tightening torque	0.8 Nm, 7 lb. in.

Consider the following when wiring the NI PS-14.

- Use appropriate copper cables that are designed for an operating temperature of:
 - 60 °C for ambient up to 45 °C.
 - 75 °C for ambient up to 60 °C minimum.
- Follow national installation codes and installation regulations.
- Ensure all strands of a stranded wire cutter enter the terminal connection.
- Up to two stranded wires with the same cross section are permitted in one connection point (except PE wire).
- Do not use the unit without the PE connection being wired.
- To fulfill GL requirements, unused terminals spaces must be closed.

Complete the following steps to connect wires to the input and output terminals.

1. Ensure that none of the wires are connected to live power.
2. Strip the ends of the wires according to the recommendations in Table 2-1.
3. Loosen the screw terminal you want to connect.
4. Insert the end of the wire into the terminal until the exposed portion of the wire is completely inside of the terminal connection. If you are using stranded wire, ensure that all strands of the wire enter the terminal connection.
5. Refasten the screw terminal.
6. Repeat steps 3 to 5 for each of the other terminals.
7. Ensure that all wires are properly seated and not loose.

8. Ensure that the rest of your equipment is ready to be powered without creating a hazard.
9. Apply MAINS voltage to the NI PS-14 power supply.

Operating the NI PS-14

This section provides general information on the operation of the NI PS-14 power supply.

Serial Operation

The NI PS-14 can operate in series to increase the output voltage. Figure 2-2 shows the NI PS-14 in a serial configuration.

Figure 2-2. NI PS-14 in Serial Operation

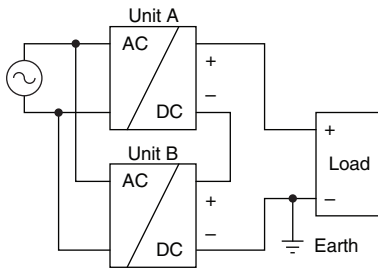

Before operating the NI PS-14 in a serial configuration, consider the following:

- It is possible to connect as many units in series as needed, providing the sum of the output voltage does not exceed $150 V_{DC}$.
- Voltages with a potential above $60 V_{DC}$ are not SELV-compliant any more and can be dangerous. Such voltages must be installed with a protection against touching.
- Use power supplies of the same type for serial operation.
- Earthing of the output is required when the sum of the output voltage is above $60 V_{DC}$.
- Keep an installation clearance of 15 mm (left/right) between two power supplies and avoid installing the power supplies on top of each other.



Caution Avoid return voltage (for example, from a decelerating motor or battery) which is applied to the output terminals.

Parallel Operation



Caution The power supply must *not* be used in parallel for the purpose of increasing the output power.

Power supplies can be paralleled for 1+1 redundancy to gain a higher system availability. Redundant systems require a certain amount of extra power to support the load in case one power supply unit fails. The simplest way is to put two NI PS-14 power supplies in parallel. If one

power supply unit fails, the other one is automatically able to support the load current without any interruption. When using this method of building a redundant system consider the following:

- The faulty power supply can not be recognized. The green LED will still be on since it is reverse-powered from the other power supply.
- It does not cover failures such as an internal short circuit in the secondary side of the power supply. In such a case (nearly impossible), the defective unit becomes a load for the other power supplies and the output voltage can not be maintained.

Recommendations for building redundant power systems:

- Use separate input fuses for each power supply.
- Monitor the individual power supply units.
- When possible, connect each power supply to different phases or circuits.

Two-Phase Power Operation

The NI PS-14 power supply can operate with two-phase power, as shown in Figure 2-3.

Figure 2-3. NI PS-14 in Two-Phase Operation

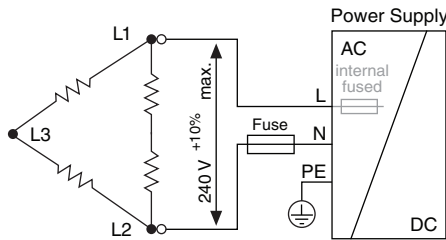

Before operating the NI PS-14 in this configuration, consider the following:

- A phase-to-phase connection is allowed as long as the supplying voltage is below 240 V +10%.
- Use a fuse or a circuit breaker to protect the N (Neutral) input. The N input is not protected internally and in two-phase configuration would be connected to a hot wire.

Appropriate fuses and circuit breakers are specified in the [External Input Protection](#) section.

External Input Protection

The NI PS-14 power supply is tested and approved for branch circuits up to 20 A. External protection is only required if the supplying branch has an ampacity greater than 20 A. In some countries local regulations might apply, so check local codes and local requirements.

If an external fuse is utilized, a minimum value is required to avoid undesired tripping of the fuse, shown in Table 2-2.

Table 2-2. Maximum and Minimum Ampacities for External Fuses

Ampacity	B-Characteristic	C-Characteristic
Minimum	10 A	6 A
Maximum	20 A	20 A

Operation in a Sealed Enclosure

When the power supply is installed in a tightly sealed enclosure, the temperature inside the enclosure will be higher than outside. The inside temperature defines the ambient temperature for the power supply.

The following is the result of such an installation, where the NI PS-14 power supply was placed in the middle of a sealed enclosure, and no other heat producer was present:

Enclosure	Rittal Type IP66 Box PK 9516 100, plastic, 110 mm × 180 mm × 165 mm
Input	230 V _{AC}
Load	24 V, 3.3 A; load is placed outside the box
Temperature inside the box	45.7 °C (in the middle of the right side of the power supply with a distance of 1 cm)
Temperature outside the box	27.3 °C
Temperature rise.....	18.4 K
Load	24 V, 2.64 A; 80% load is placed outside the box
Temperature inside the box	41.8 °C (in the middle of the right side of the power supply with a distance of 1 cm)
Temperature outside the box	26.5 °C
Temperature rise.....	15.3 K

Cooling

The NI PS-14 is convection cooled, and direct cooling is not required. However, you must not cover the ventilation grid (for example, with cable conduits) by more than 30%.

Proper installation clearance for the NI PS-14 is 40 mm on top, 20 mm on the bottom, 5 mm on the left and right side when loaded permanently with full power. If the adjacent device is a heat source, 15 mm clearance is recommended between the NI PS-14 and the adjacent device.

Hazardous Risks



Caution Do not use the unit without the proper earth connection (Protective Earth). Use the PE pin on the front panel terminal block for earth connection instead of one of the screws on the housing.

Turn the power off before working on the power supply. Protect against inadvertent re-powering.

Make sure the wiring is correct by following all local and national codes.

Do not open, modify, or repair the unit.

Use caution to prevent any foreign objects from entering into the housing.

Do not use in wet locations or in areas where moisture or condensation can be expected.

Service Parts

The NI PS-14 power supply does not contain any serviceable parts. If an internal fuse trips, it is caused by an internal defect. If damage or malfunction occurs during operation, immediately turn the power off and send the NI PS-14 to National Instruments for inspection.



Note Attempting to repair or modify the NI PS-14 power supply will void your warranty.

Peak Current Capability

Solenoids, contactors and pneumatic modules often have a steady state coil and a pick-up coil. The inrush current demand of the pick-up coil is several times higher than the steady state current and usually exceeds the nominal output current (including the PowerBoost). The same situation applies when starting a capacitive load.

Branch circuits are often protected with circuit breakers or fuses. In case of a short or an overload in the branch circuit, the fuse needs a certain amount of over-current to trip or to blow. The peak current capability ensures the safe operation of subsequent circuit breakers.

Assuming the input voltage is turned on before such an event, the built-in large sized output capacitors inside the power supply can deliver extra current. Discharging this capacitor causes a voltage dip on the output. Figure 2-4 illustrates two typical voltage dips.

Figure 2-4. Peak Current Capacity Output Voltage Dips

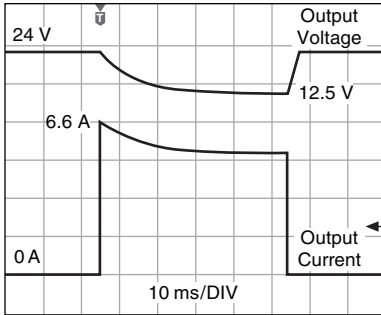

Peak Load 6.6 A (Resistive) for 50 ms
Output Voltage Dips From 24 V to 12.5 V.

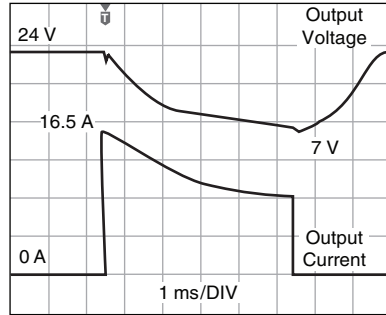

Peak Load 16.5 A (Resistive) for 5 ms
Output Voltage Dips From 24 V to 7 V.

Charging Batteries

The NI PS-14 power supply should *not* be used to charge batteries.

Back Feeding Loads

Loads such as decelerating motors and inductors can feed voltage back to the power supply. This feature is also called return voltage immunity or resistance against back-EMF (Electro Magnetic Force). The NI PS-14 power supply is resistant to this and does not malfunction when a load feeds back voltage to the power supply, regardless of whether the power supply itself is on or off.

The maximum allowed feed back voltage is 35 V_{DC}. The absorbing energy can be calculated according to the built-in large sized output capacitor, which is specified in the *Output* section of Appendix A, *Specifications*.

Output Circuit Breakers

Standard miniature circuit breakers (MCBs) can be used for branch protection. Ensure that the MCB is also rated for DC voltage. The following two tests show which circuit breakers the power supply typically trips.



Note Circuit breakers have large tolerances in their tripping behavior. Therefore, these typical tests can only be used as a recommendation or for comparing two different power supplies. Furthermore, the loop impedance has a major influence on whether a breaker trips or not.

Test 1: Short circuit with S1 on the power supply end of the cable (loop impedance approximately 20 mΩ). The input voltage was 230 V_{AC} and the load current was 0 A.

Figure 2-5. Breaker Trip Test 1

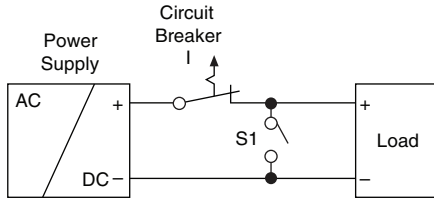

The following circuit breaker tripped during the test:

- A or Z-Characteristic ≤6 A
- B-Characteristic No tripping ≥6 A
No breaker available <6 A
- C-Characteristic ≤1 A

Test 2: Short circuit with S1 on the load end (additional impedance is included in the form of longer load wire length). The input voltage was 230 V_{AC} and the load current was 0 A.

Figure 2-6. Breaker Trip Test 2

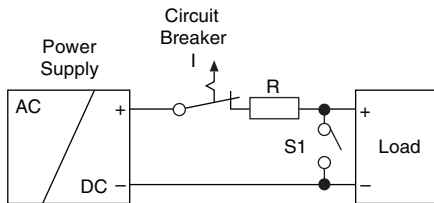

The following circuit breaker tripped during the test:

- A or Z-Characteristic ≤4 A and R = 220 mΩ
- B-Characteristic No tripping ≥6 A
No breaker available <6 A
- C-Characteristic ≤1 A and R = 390 mΩ

Table 2-3 provides a comparison of resistances in terms of wire gauge and length.

Table 2-3. Resistances for Wire Gauges and Lengths

Resistance	0.5 mm ²	0.7 mm ²	1.0 mm ²	1.5 mm ²	2.5 mm ²	4.0 mm ²
220 mΩ	6.1 m	8.6 m	12.3 m	18.4 m	30.6 m	49 m
390 mΩ	10.9 m	15.2 m	21.7 m	32.6 m	54.3 m	86.9 m

For example: Which wire gauge must be used to trip a C-Characteristic circuit breaker with a rating of 1 A? The load wire length is 25 m.

Answer: A 1 A C-Characteristic circuit breaker requires a loop impedance of less than 390 m Ω (test results). Table 2-3 shows that up to 32.6 m of wire with a cross section of 1.5 mm² is below 390 m Ω . You should not use a wire smaller than 1.5 mm².

Inductive and Capacitive Loads

The NI PS-14 is designed to supply any kind of load, including unlimited capacitive and inductive loads.

Specifications

This appendix contains specifications for the NI PS-14 power supply.



Note Specifications are subject to change without notice.



Caution Must be mounted in an enclosure by qualified personnel. Refer to Figure A-1 for more information.

This power supply is designed for installation in an enclosure and is intended for general use, such as in industrial control, office, communication, and instrumentation equipment. Do not use this device in aircraft, trains and nuclear equipment, where malfunctioning of the power supply may cause severe personal injury or threaten human life.

Dimensions and Weight

Dimensions

Width	32 mm
Height	124 mm
Depth	102 mm

Weight..... 430 g (0.95 lb)

Figure A-1. NI PS-14 Power Supply

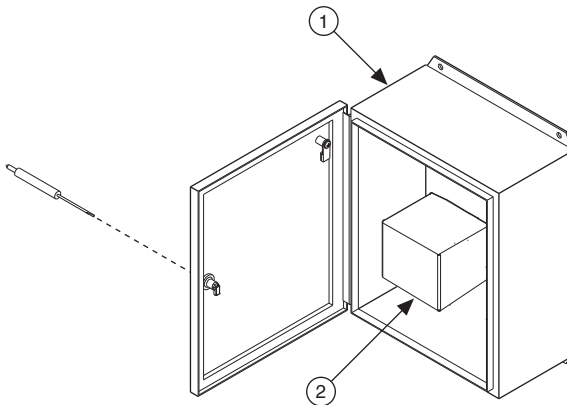

1 Suitably rated NEMA or IP enclosure that requires tool access

2 NI PS-14 Power Supply

Figure A-2. NI PS-14 Dimensions

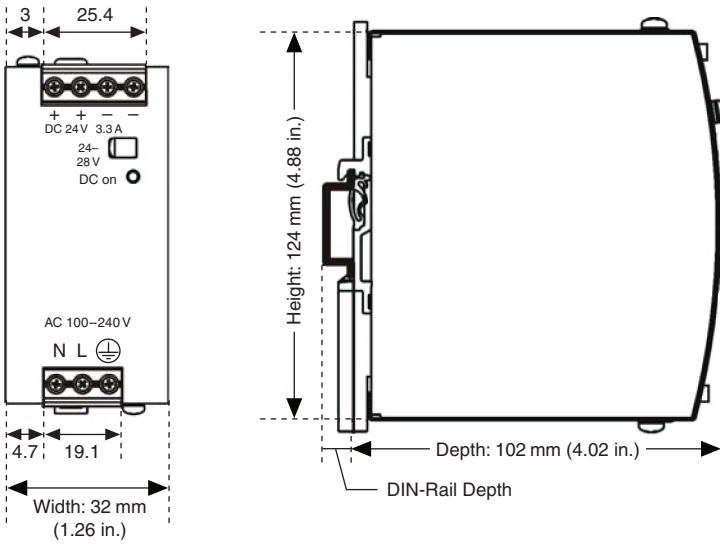

AC Input

AC input	Nominal AC 100 to 240 V	Wide-range input, TN-, TT-, IT-Mains, refer to Figure A-3
AC input range	90 to 264 V _{AC}	100 to 120 V range, continuous operation
	85 to 90 V _{AC}	Short term or with output derating
	264 to 300 V _{AC}	<0.5 s
Input frequency	Nominal 50 to 60 Hz	±6%
Turn-on voltage	Typical 75 V _{AC}	Steady-state value, refer to Figure A-3
Shut-down voltage	Typical 58 V _{AC}	Steady-state value, refer to Figure A-3

	Typical/ Maximum	AC 100 V	AC 120 V	AC 230 V	
Input current	Typical	1.5 A	1.24 A	0.68 A	At 24 V, 3.3 A, refer to Figure A-5
Power factor*	Typical	0.62	0.61	0.56	At 24 V, 3.3 A, refer to Figure A-3
Crest factor†	Typical	3.1	3.2	4.0	At 24 V, 3.3 A
Start-up delay	Typical	95 ms	95 ms	95 ms	Refer to Figure A-4
Rise time	Typical	18 ms	29 ms	56 ms	0 mF, 24 V, 3.3 A, refer to Figure A-4
	Typical	35 ms	52 ms	52 ms	3.3 mF, 24 V, 3.3 A, refer to Figure A-4
Turn-on overshoot	Maximum	400 mV	400 mV	400 mV	Refer to Figure A-4
Turn-on voltage	Typical	75 V _{AC}	75 V _{AC}	75 V _{AC}	Steady-state value, refer to Figure A-3
Shut-down voltage	Typical	58 V _{AC}	58 V _{AC}	58 V _{AC}	Steady-state value, refer to Figure A-3

* The power factor is the ratio of the true (or real) power to the apparent power in an AC circuit.
 † The crest factor is the mathematical ratio of the peak value to the RMS value of the input current waveform.

Figure A-3. Input Voltage Range

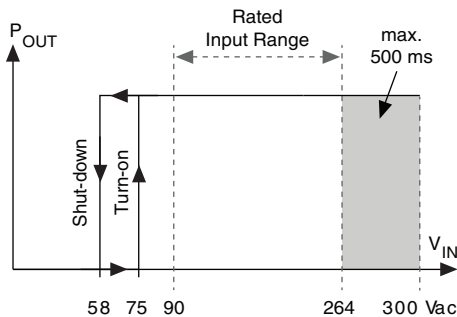

Figure A-4. Turn On Behavior, Definitions

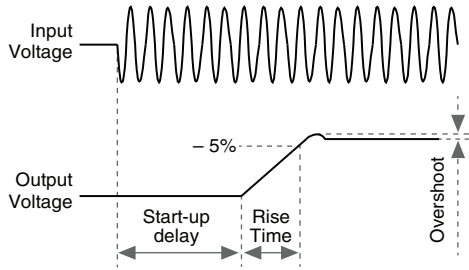

Figure A-5. Input Current Vs. Output Load

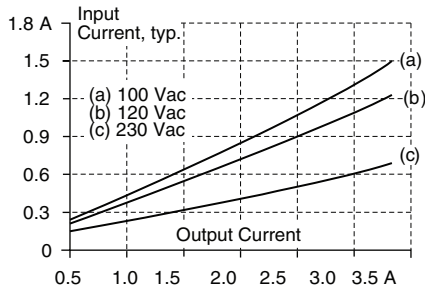
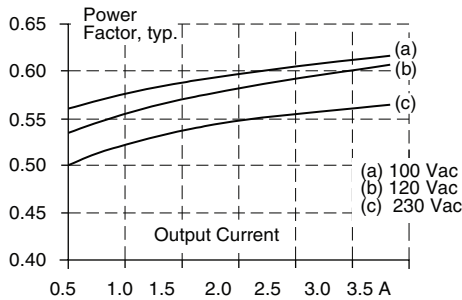

Figure A-6. Power Factor Vs. Output Load



DC Input

DC input	Nominal	110 to 300 V _{DC}	—
DC input range	Minimum	88 to 375 V _{DC}	Continuous operation
DC input current	Typical	0.81 A/0.29 A	110 V _{DC} /300 V _{DC} , 24 V, 3.3 A

Output current	Maximum	2.5 A	At 24 V and an input voltage between 88 to 110 V _{DC} refer to Figure A-7
	Maximum	3.3 A	At 24 V and an input voltage between 110 to 375 V _{DC} refer to Figure A-7
Turn-on voltage	Typical	103 V _{DC}	Steady state value at 2.5 A output load
Shut-down voltage	Typical	50 V _{DC}	Steady state value at 2.5 A output load

Figure A-7. Output Current Vs. Input Voltage

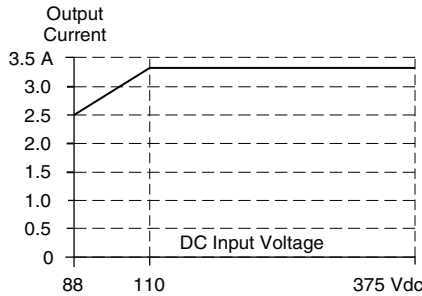

Input Current Inrush Surge

An active inrush limitation circuit limits the input inrush current after input voltage is applied. The charging current into EMI suppression capacitors is disregarded in the first milliseconds after power up.

	Typical/ Maximum	AC 100 V	AC 120 V	AC 230 V	
Inrush current	Maximum	24 A _{peak}	28 A _{peak}	54 A _{peak}	At 40 °C cold-start
	Typical	20 A _{peak}	23 A _{peak}	45 A _{peak}	
Inrush energy	Typical	0.4 A ² s	0.5 A ² s	1.7 A ² s	At 40 °C cold-start

Figure A-8. Input Inrush Current, Typical Behavior

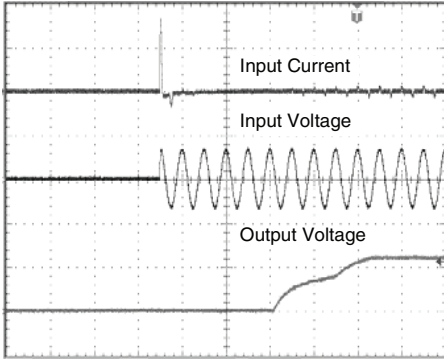

A: Start-up delay = Inrush delay
 Input: 230 Vac
 Output: 24 V, 3.3 A
 Ambient: 25 °C
 Upper curve: Input current 20 A / DIV
 Medium curve: Input voltage 500 V / DIV
 Lower curve: Output voltage 20 V / DIV
 Time scale: 40 ms / DIV

Hold-up Time

	Typical/ Maximum	AC 100 V	AC 120 V	AC 230 V	
Hold-up Time	Typical	38 ms	60 ms	244 ms	1.65 A, 24 V, refer to Figure A-9
	Typical	19 ms	29 ms	120 ms	3.3 A, 24 V, refer to Figure A-9

Figure A-9. Hold-Up Time Vs. Input Voltage

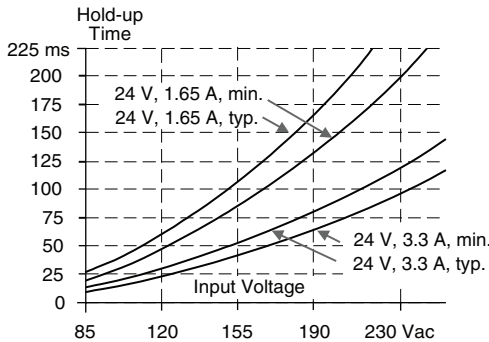
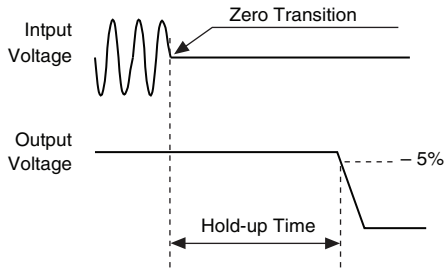

Figure A-10. Shutdown Behavior, Definitions



Note At no load, the hold-up time can be up to several seconds. The green DC OK LED is lit during this time.

Output

Output voltage	Nominal	24 V	—
Adjustment range	Minimum Maximum	24 to 28 V 30 V	Guaranteed At clockwise end position of potentiometer
Factory setting	—	24.1 V	±0.2%, at full load, cold unit
Line regulation	Maximum	50 mV	90 V _{AC} to 264 V _{AC}
Load regulation	Maximum	100 mV	Static value, 0 A → 3.3 A → 0 A
Ripple and noise voltage	Maximum	50 mVpp	20 Hz to 20 MHz, 50 Ω
Output capacitance	Typical	1,450 μF	—
Output current	Nominal	3.3 A	At 24 V, refer to Figure A-11
	Nominal	2.7 A	At 28 V, refer to Figure A-11
Output power	Nominal	80 W	—
Short-circuit current	Minimum	4 A	Load impedance 250 mΩ, refer to Figure A-11
	Maximum	8 A	

Figure A-11. Output Voltage Vs. Output Current, Typical

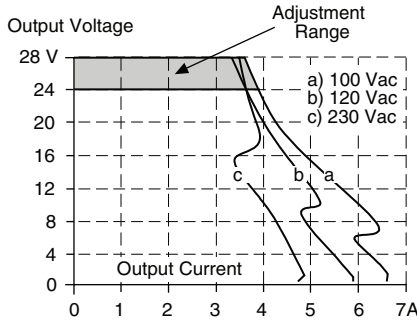

Peak Current Capability

The power supply can deliver a peak current which is higher than the specified short term current. This helps to start current-demanding loads or to safely operate subsequent circuit breakers.

The extra current is supplied by the output capacitors inside the power supply. During this event, the capacitors will be discharged and cause a voltage dip on the output. Detailed curves can be found in the *Peak Current Capability* section of Chapter 2, *Installation and Configuration*.

Peak current voltage dips	Typical	From 24 V to 12.5 V	At 6.6 A for 50 ms, resistive load
	Typical	From 24 V to 12.5 V	At 16.5 A for 2 ms, resistive load
	Typical	From 24 V to 7 V	At 16.5 A for 5 ms, resistive load

Efficiency and Power Losses

		AC 100 V	AC 120 V	AC 230 V	
Efficiency	Typical	86.4%	88.0%	89.8%	3.3 A, 24 V
Power losses	Typical	1 W	1.1 W	1.8 W	0 A
	Typical	5.4 W	4.9 W	5.9 W	1.65 A, 24 V
	Typical	12.5 W	11.1 W	9.1 W	3.3 A, 24 V

Figure A-12. NI PS-14 Efficiency and Losses

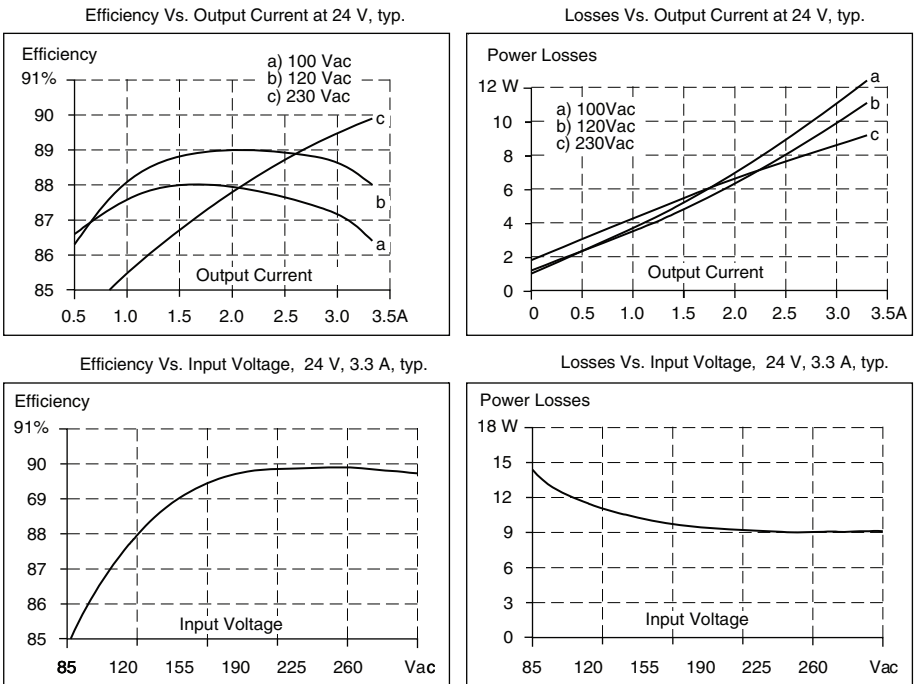

Reliability

The lifetime expectancy shown in Table A-1 indicates the service life of the NI PS-14, and is determined by the lifetime expectancy of the built-in electrolytic capacitors. Lifetime expectancy is specified in operational hours. Lifetime expectancy is calculated according to the capacitor’s manufacturer specification. The prediction model allows a calculation of up to 15 years from the date of shipment.

MTBF (Mean Time Between Failure) is calculated according to statistical device failures and indicates reliability of a device. It is the statistical representation of the likelihood of a unit to fail and does not necessarily represent the life of a product.

Table A-1. Reliability Specifications

	Minimum/ Maximum	AC 100 V	AC 120 V	AC 230 V	
Lifetime expectancy	Minimum	57,000 hours	64,000 hours	77,000 hours	40 °C, 24 V, 3.3 A
	Minimum	160,000 hours	> 15 years	> 15 years	25 °C, 24 V, 3.3 A
MTBF SN 29500, IEC 61709	—	1,788,007 hours	1,901,430 hours	2,242,997 hours	40 °C, 24 V, 3.3 A
	—	3,131,282 hours	3,286,512 hours	3,796,377 hours	25 °C, 24 V, 3.3 A
MTBF MIL HDBK 217F	—	848,860 hours	854,142 hours	885,842 hours	40 °C, 24 V, 3.3 A, Ground Benign GB40
	—	1,088,361 hours	1,094,559 hours	1,152,637 hours	25 °C, 24 V, 3.3 A, Ground Benign GB25

Dielectric Strength



Note The output voltage is floating and has no ohmic connection to ground.

To fulfill the PELV requirements according to EN60204-1 § 6.4.1, we recommend that either the + pole, the - pole or any other part of the output circuit should be connected to the protective earth system. This helps to avoid situations in which a load starts unexpectedly or can not be switched off when unnoticed earth faults occur.

Figure A-13. Dielectric Strength

Table A-2 lists the tests that have been run to determine the NI PS-14 dielectric strength, and the results of each test.

Table A-2. Dielectric Strength Test Results

Test	Duration	A	B	C
Type test	60 s	2500 V _{AC}	3000 V _{AC}	500 V _{AC}
Factory test	5 s	2500 V _{AC}	2500 V _{AC}	500 V _{AC}
Field test	5 s	2000 V _{AC}	2000 V _{AC}	500 V _{AC}

Type tests and factory tests

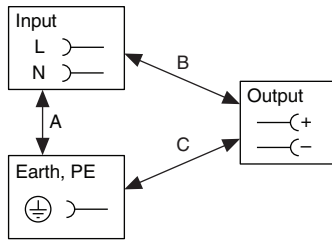
Conducted by the manufacturer. Do *not* repeat test in field.

Rules for field test

Use appropriate test equipment which applies the voltage with a slow ramp. Connect L and N together as well as all output poles.

Used Substances

- This unit does not release any silicone and is suitable for use in paint shops.
- This unit conforms to RoHS directive 2002/96/EC.
- Electrolytic capacitors included in this unit do not use electrolytes such as Quaternary Ammonium Salt Systems.
- Plastic housings and other molded plastic materials are free of halogens, wires and cables are not PVC insulated.
- The production material within our production does not include following toxic chemicals: Polychlorized Biphenyl (PCB), Polychlorized Terphenyl (PCT), Pentachlorophenol (PCP), Polychlorinated naphthalene (PCN), Polybrom Biphenyl (PBB), Polybrom Bipheny-oxyd (PBO), Polybrominated Diphenylether (PBDE), Polychlorinated Diphenylether (PCDE), Polydibromphenyl Oxyd (PBDO), Cadmium, Asbest, Mercury, Silicia.

Environment

Operational temperature	-25 °C to +70 °C (-13 °F to 158 °F)	Resistive load Reduce output power according to Figure A-14
Output de-rating	1.8 W/°C	60 to 70 °C (140 °F to 158 °F)
Storage temperature	-40 to +85 °C (-40 °F to 185 °F)	Storage and transportation
Humidity	5 to 95% r.H.	IEC 60068-2-30 Do not energize while condensation is present
Vibration sinusoidal	2 to 17.8 Hz: ±1.6 mm; 17.8 to 500 Hz: 2 g 2 hours / axis	IEC 60068-2-6
Shock	30 g 6 ms, 20 g 11 ms 3 bumps/direction, 18 bumps total	IEC 60068-2-27
Altitude	0 to 6000 m (0 to 20,000 ft)	Reduce output power or ambient temperature above 2000 m sea level
Output de-rating (for altitude)	5 W/1000 m or 5 °C/1000 m	Above 2000 m (6500 ft), refer to Figure A-15
Over-voltage category	III	EN 50178, altitudes up to 2000 m
	II	Altitudes from 2000 m to 6000 m
Degree of pollution	2	EN 50178, IEC 62103 not conductive

Figure A-14. Output Current Vs. Ambient Temperature

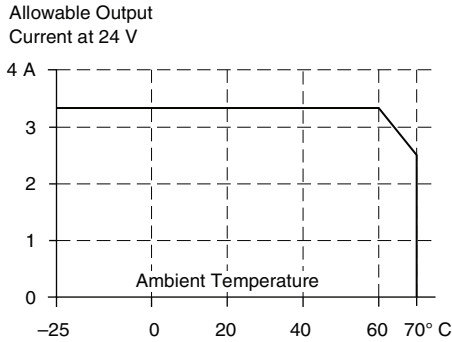

Note The ambient temperature is defined as the temperature 2 cm below the NI PS-14.

Figure A-15. Output Current Vs. Altitude

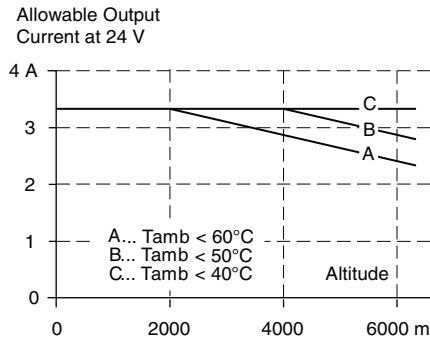

Protection Features

Output protection	Electronically protected against overload, no-load and short-circuits	
Output over-voltage protection	Typical 34 V _{DC} Maximum 39 V _{DC}	In case of an internal power supply defect, a redundant circuitry limits the maximum output voltage. The output shuts down and automatically attempts to restart.
Output over-current protection	Electronically limited	Refer to Figure A-11.
Degree of protection	IP 20	EN/IEC 60529

Penetration protection	>3.5 mm	From screws, small parts, and so on
Over-temperature protection	No	—
Input transient protection	MOV	Metal Oxide Varistor
Internal input fuse	T6.3A H.B.C.	Not user replaceable



Note In case of a protection event, audible noise may occur.

Safety

This product is designed to meet the requirements of the following standards of safety for industrial control and information technology equipment:

- IEC/EN 60950-1, UL 508



Note For UL and other safety certifications, refer to the product label or the [Online Product Certification](#) section.

Electromagnetic Compatibility

This product is designed to meet the requirements of the following standards of EMC for industrial control and information technology equipment:

EMC Immunity	EN 61000-6-2 EN 61000-6-1	Generic standards		
Electrostatic discharge	EN 61000-4-2	Contact discharge Air discharge	8 kV 15 kV	Criterion A Criterion A
Electromagnetic RF field	EN 61000-4-3	80 MHz to 2.7 GHz	10 V/m	Criterion A
Fast transients (Burst)	EN 61000-4-4	Input lines Output lines	4 kV 2 kV	Criterion A Criterion A
Surge voltage on input	EN 61000-4-5	L → N N/L → PE	2 kV 4 kV	Criterion A Criterion A
Surge voltage on output	EN 61000-4-5	+ → - +/- → PE	500 V 500 V	Criterion A Criterion A

Conducted disturbance	EN 61000-4-6	0.15 to 80 MHz	10 V	Criterion A
Mains voltage dips	EN 61000-4-11	0% of 100 V _{AC}	0 V _{AC} , 20 ms	Criterion B*
		40% of 100 V _{AC}	40 V _{AC} , 200 ms	Criterion C
		70% of 100 V _{AC}	70 V _{AC} , 500 ms	Criterion A
		0% of 200 V _{AC}	0 V _{AC} , 20 ms	Criterion A
		40% of 200 V _{AC}	80 V _{AC} , 200 ms	Criterion A
		70% of 200 V _{AC}	140 V _{AC} , 500 ms	Criterion A
Voltage interruptions	EN 61000-4-11	—	0 V _{AC} , 5000 ms	Criterion C
Powerful transients	VDE 0160	Over entire load range	750 V, 1.3 ms	Criterion A
<p>Criteria:</p> <p>A: Power supply shows normal operation behavior within the defined limits.</p> <p>B: The power supply continuous to operate as intended after the test. No degradation of performance or loss of function occur, when the power supply is used as intended. During the test, degradation of performance is however possible.</p> <p>C: Temporary loss of function is possible. Power supply might shut-down and restarts by itself. No damages or hazards for the power supply occur.</p> <p>* Below 2.8 A criterion A is fulfilled.</p>				

Switching Frequency

50 kHz to 450 kHz..... Input voltage and load dependent

EMC Emission	EN 61000-6-3, EN 61000-6-4	Generic standards
Conducted emission	EN 55011, EN 55022, FCC Part 15, CISPR 11, CISPR 22	Class B, input lines
	EN 55022	Class A, output lines

Radiated emission	EN 55011, EN 55022	Class B
Harmonic input current	EN 61000-3-2	Fulfilled (Class A)
Voltage fluctuations, flicker	EN 61000-3-3	Fulfilled



Note This device complies with FCC Part 15 rules.

Operation is subjected to following two conditions: (1) this device may not cause harmful interference, and (2) this device must accept any interference received, including interference that may cause undesired operation.

A power supply has to comply with EN 61000-3-2 (Standard for harmonic input current) when:

- the end-device is used within the European Union and
- the end-device is connected to a public mains supply with a nominal voltage greater than or equal to $220 V_{AC}$ and
- the power supply is:
 - fitted in an end-device with an average input power in excess of 75 W
 - or
 - fitted in an end-device with a continuous input power in excess of 75 W
 - or
 - part of a lighting system.

Exceptions

End-devices for professional applications with an input power >1000 W do not need to fulfill EN 61000-3-2.

Comments

- The average input power must be determined in accordance with EN 61000-3-2.
- Industrial MAINS supplies with their own transformer are considered to be *non-public*.
- Where individual self-contained items of equipment are installed in a rack or case (for example, devices connected in parallel), they are regarded as being individually connected to the MAINS supply. The rack or case need not be tested as a whole. Alternatively, it is also permitted to assess the whole rack or case. This is recommended for devices used in professional applications with an input power greater than 1000 W.



Note For the standards applied to assess the EMC of this product, refer to the *Online Product Certification* section.





For EMC compliance, operate this device with shielded cabling.

CE Compliance

This product meets the essential requirements of applicable European Directives as follows:

- 2006/95/EC; Low-Voltage Directive (safety)
- 2004/108/EC; Electromagnetic Compatibility Directive (EMC)

Certifications

	LISTED as Industrial Control Equipment (UL 508)
	RECOGNIZED as Information Technology Equipment (UL 60950-1)
	Class I Div. 2, Certificate. For Hazardous Locations.
	GL (Germanischer Lloyd) classified for marine and offshore applications. Environmental category: C, EMC2

Online Product Certification

Refer to the product Declaration of Conformity (DoC) for additional regulatory compliance information. To obtain product certifications and the DoC for this product, visit ni.com/certification, search by model number or product line, and click the appropriate link in the Certification column.

Environmental Management

NI is committed to designing and manufacturing products in an environmentally responsible manner. NI recognizes that eliminating certain hazardous substances from our products is beneficial to the environment and to NI customers.

For additional environmental information, refer to the *Minimize Our Environmental Impact* web page at ni.com/environment. This page contains the environmental regulations and directives with which NI complies, as well as other environmental information not included in this document.

Waste Electrical and Electronic Equipment (WEEE)



EU Customers At the end of the product life cycle, all products *must* be sent to a WEEE recycling center. For more information about WEEE recycling centers, National Instruments WEEE initiatives, and compliance with WEEE Directive 2002/96/EC on Waste and Electronic Equipment, visit ni.com/environment/weee.

电子信息产品污染控制管理办法（中国 RoHS）



中国客户 National Instruments 符合中国电子信息产品中限制使用某些有害物质指令 (RoHS)。关于 National Instruments 中国 RoHS 合规性信息，请登录 ni.com/environment/rohs_china。(For information about China RoHS compliance, go to ni.com/environment/rohs_china.)

Technical Support and Professional Services

Log in to your National Instruments ni.com User Profile to get personalized access to your services. Visit the following sections of ni.com for technical support and professional services:

- **Support**—Technical support at ni.com/support includes the following resources:
 - **Self-Help Technical Resources**—For answers and solutions, visit ni.com/support for software drivers and updates, a searchable KnowledgeBase, product manuals, step-by-step troubleshooting wizards, thousands of example programs, tutorials, application notes, instrument drivers, and so on. Registered users also receive access to the NI Discussion Forums at ni.com/forums. NI Applications Engineers make sure every question submitted online receives an answer.
 - **Standard Service Program Membership**—This program entitles members to direct access to NI Applications Engineers via phone and email for one-to-one technical support, as well as exclusive access to self-paced online training modules at ni.com/self-paced-training. All customers automatically receive a one-year membership in the Standard Service Program (SSP) with the purchase of most software products and bundles including NI Developer Suite. NI also offers flexible extended contract options that guarantee your SSP benefits are available without interruption for as long as you need them. Visit ni.com/ssp for more information.
For information about other technical support options in your area, visit ni.com/services, or contact your local office at ni.com/contact.
- **Training and Certification**—Visit ni.com/training for training and certification program information. You can also register for instructor-led, hands-on courses at locations around the world.
- **System Integration**—If you have time constraints, limited in-house technical resources, or other project challenges, National Instruments Alliance Partner members can help. To learn more, call your local NI office or visit ni.com/alliance.
- **Declaration of Conformity (DoC)**—A DoC is our claim of compliance with the Council of the European Communities using the manufacturer’s declaration of conformity. This system affords the user protection for electromagnetic compatibility (EMC) and product safety. You can obtain the DoC for your product by visiting ni.com/certification.
- **Calibration Certificate**—If your product supports calibration, you can obtain the calibration certificate for your product at ni.com/calibration.

You also can visit the Worldwide Offices section of ni.com/niglobal to access the branch office Web sites, which provide up-to-date contact information, support phone numbers, email addresses, and current events.

Index

A

AC input specifications, A-2

B

back feeding loads, 2-8

C

calibration certificate (NI resources), B-1

capacitive loads, 2-10

CE compliance, specifications, A-17

certification specifications, A-17

charging batteries, use, 2-8

circuit breakers, output, 2-8

cooling the NI PS-14, 2-7

current capability, peak, 2-7

figure, 2-8

D

DC input

specifications, A-4

Declaration of Conformity (NI

resources), B-1

diagnostic tools (NI resources), B-1

dielectric strength specifications, A-10

dimension specifications, A-1

documentation

NI resources, B-1

related documentation, *ix*

drivers (NI resources), B-1

E

efficiency specifications, A-8

electromagnetic compatibility, A-14

enclosure, sealed operation, 2-6

environment specifications, A-12

environmental management,

specifications, A-17

examples (NI resources), B-1

external input protection, 2-6

H

hazardous risks, 2-7

help, technical support, B-1

hold-up time specifications, A-6

I

inductive loads, 2-10

input current inrush surge, A-5

input protection, 2-6

installation, configuration, and operation

mounting the NI PS-14, 2-1

unpacking the NI PS-14, 1-1

wiring the NI PS-14, 2-3

instrument drivers (NI resources), B-1

K

kit contents, 1-1

KnowledgeBase, B-1

L

loads

back feeding, 2-8

inductive, capacitive, 2-10

M

mounting equipment, 1-4

panel kit, 1-4

side brackets, 1-4

mounting orientation, 2-1

N

National Instruments support and
services, B-1

NI PS-14

cooling, 2-7

external input protection, 2-6

hazardous risks, 2-7

mounting equipment, 1-4

panel brackets, 1-4

side brackets, 1-4

- operation, 2-4
 - parallel, 2-4
 - serial, 2-4
 - figure, 2-4
 - two-phase, 2-5
- orientation, 2-1
 - figure, 2-2
- peak current capability, 2-7
- service parts, 2-7
- specifications, A-1
- unpacking, 1-1
- wiring terminals, 2-3

NI support and services, B-1

O

operating in a sealed enclosure, 2-6

operation

- parallel, 2-4
- serial, 2-4
 - figure, 2-4
- two phase, 2-5
 - figure, 2-5

output circuit breakers, 2-8

output specifications, A-7

P

panel mounting kit, 1-4

parallel operation, 2-4

parts, service, 2-7

peak current capability, 2-7

- figure, 2-8
- specifications, A-8

power loss specifications, A-8

programming examples (NI resources), B-1

protection features specifications, A-13

R

related documentation, *ix*

reliability specifications, A-9

risks, 2-7

S

safety, specifications, A-14

sealed enclosure, operation, 2-6

serial operation, 2-4

service parts, 2-7

side mounting kit, 1-4

software (NI resources), B-1

specifications

- AC input, A-2
- CE compliance, A-17
- certifications, A-17
- current inrush surge, A-5
- DC input, A-4
- dielectric strength, A-10
- dimensions, A-1
- efficiency, A-8
- electromagnetic compatibility, A-14
- environment, A-12
- environmental management, A-17
- hold-up time, A-6
- online product certification, A-17
- output, A-7
- peak current capability, A-8
- power loss, A-8
- protection features, A-13
- reliability, A-9
- safety, A-14
- substances used, A-11
- weight, A-1

support, technical, B-1

surge, input current inrush, A-5

T

terminal wiring, 2-3

requirements (table), 2-3

training and certification (NI resources), B-1

troubleshooting (NI resources), B-1

two-phase operation, 2-5

figure, 2-5

U

unpacking the NI PS-14 power supply, 1-1

use for charging batteries, 2-8

used substances specifications, A-11

W

Web resources, B-1

weight specifications, A-1

wiring the terminals, 2-3

 requirements (table), 2-3