

COMPREHENSIVE SERVICES

We offer competitive repair and calibration services, as well as easily accessible documentation and free downloadable resources.

SELL YOUR SURPLUS

We buy new, used, decommissioned, and surplus parts from every NI series. We work out the best solution to suit your individual needs.

 Sell For Cash  Get Credit  Receive a Trade-In Deal

OBSOLETE NI HARDWARE IN STOCK & READY TO SHIP

We stock **New**, **New Surplus**, **Refurbished**, and **Reconditioned** NI Hardware.



Bridging the gap between the manufacturer and your legacy test system.

 1-800-915-6216

 www.apexwaves.com

 sales@apexwaves.com

All trademarks, brands, and brand names are the property of their respective owners.

Request a Quote

 **CLICK HERE**

cRIO-9030

PRODUCT FLYER

CompactRIO Controllers

CONTENTS

[CompactRIO Controllers](#)

[Detailed View of cRIO-9039](#)

[Heterogeneous Architecture](#)

[Integrated Software](#)

[Extensive I/O](#)

[Ruggedness](#)

[Time Sensitive Networking](#)

[Platform-Based Approach to Control and Monitoring](#)

[Hardware Services](#)

CompactRIO Controllers

cRIO-9063, cRIO-9064, cRIO-9065, cRIO-9066, cRIO-9067, cRIO-9068, cRIO-9030, cRIO-9031, cRIO-9032, cRIO-9033, cRIO-9034, cRIO-9035, cRIO-9036, cRIO-9037, cRIO-9038, and cRIO-9039



- Modular, high-performance embedded controllers for industrial deployment
- NI Linux Real-Time OS for reliability, security, and determinism
- Industrial-grade processing component options from ARM, Intel, and Xilinx
- Time Sensitive Networking (TSN) enabled Ethernet ports
- Up to -40 °C to 70 °C temperature range, up to 50 g shock and 5 g vibration
- 200+ I/O modules to support a variety of sensors and signal types
- LabVIEW graphical development platform eliminates the need for hardware description language (HDL) expertise to use reconfigurable FPGA hardware

Built for Embedded Control and Monitoring

CompactRIO Controllers are modular, high-performance embedded controllers for rapid development and deployment into industrial control and monitoring applications.

They feature extreme ruggedness, industry-standard certifications, modular I/O, and integrated motion, vision, industrial communication, and HMI capabilities. C Series modules deliver high-accuracy I/O with measurement-specific signal conditioning so you can connect to any sensor or device on any bus.

Using the productive, integrated NI software toolchain, you can customize and reconfigure CompactRIO Controllers through software to rapidly deliver complex embedded control and monitoring systems.

Table 1. NI offers CompactRIO Controllers with processors ranging from ARM Cortex-A9 to Intel Atom.

Model	Processor Core	FPGA	Hard Drive	RAM	I/O Slot Count	Temperature Range
cRIO-9030	1.33 GHz Dual-Core Intel Atom	Kintex-7 70T	4 GB	1 GB	4	-20 °C to 55 °C
cRIO-9031	1.33 GHz Dual-Core Intel Atom	Kintex-7 70T	4 GB	1 GB	4	-40 °C to 70 °C
cRIO-9032 ¹	1.33 GHz Dual-Core Intel Atom	Kintex-7 160T	8 GB	2 GB	4	-20 °C to 55 °C
cRIO-9033	1.33 GHz Dual-Core Intel Atom	Kintex-7 160T	8 GB	2 GB	4	-40 °C to 70 °C
cRIO-9034	1.91 GHz Quad-Core Intel Atom	Kintex-7 325T	16 GB	2 GB	4	-20 °C to 55 °C
cRIO-9035 ²	1.33 GHz Dual-Core Intel Atom	Kintex-7 70T	4 GB	1 GB	8	-20 °C to 55 °C
cRIO-9036	1.33 GHz Dual-Core Intel Atom	Kintex-7 70T	4 GB	1 GB	8	-40 °C to 70 °C
cRIO-9037 ¹	1.33 GHz Dual-Core Intel Atom	Kintex-7 160T	8 GB	2 GB	8	-20 °C to 55 °C
cRIO-9038	1.33 GHz Dual-Core Intel Atom	Kintex-7 160T	8 GB	2 GB	8	-40 °C to 70 °C
cRIO-9039 ²	1.91 GHz Quad-Core Intel Atom	Kintex-7 325T	16 GB	2 GB	8	-20 °C to 55 °C
cRIO-9063	667 MHz Dual-Core ARM Cortex-A9	Zynq-7000 (Z-7020)	512 MB	256 MB	4	-20 °C to 55 °C
cRIO-9064	667 MHz Dual-Core ARM Cortex-A9	Zynq-7000 (Z-7020)	1 GB	512 MB	4	-20 °C to 55 °C
cRIO-9065	667 MHz Dual-Core ARM Cortex-A9	Zynq-7000 (Z-7020)	1 GB	512 MB	4	-40 °C to 70 °C
cRIO-9066	667 MHz Dual-Core ARM Cortex-A9	Zynq-7000 (Z-7020)	512 MB	256 MB	8	-20 °C to 55 °C
cRIO-9067	667 MHz Dual-Core ARM Cortex-A9	Zynq-7000 (Z-7020)	1 GB	512 MB	8	-20 °C to 55 °C
cRIO-9068	667 MHz Dual-Core ARM Cortex-A9	Zynq-7000 (Z-7020)	1 GB	512 MB	8	-40 °C to 70 °C

¹ Wireless

² TSN Option Available

Detailed View of cRIO-9039

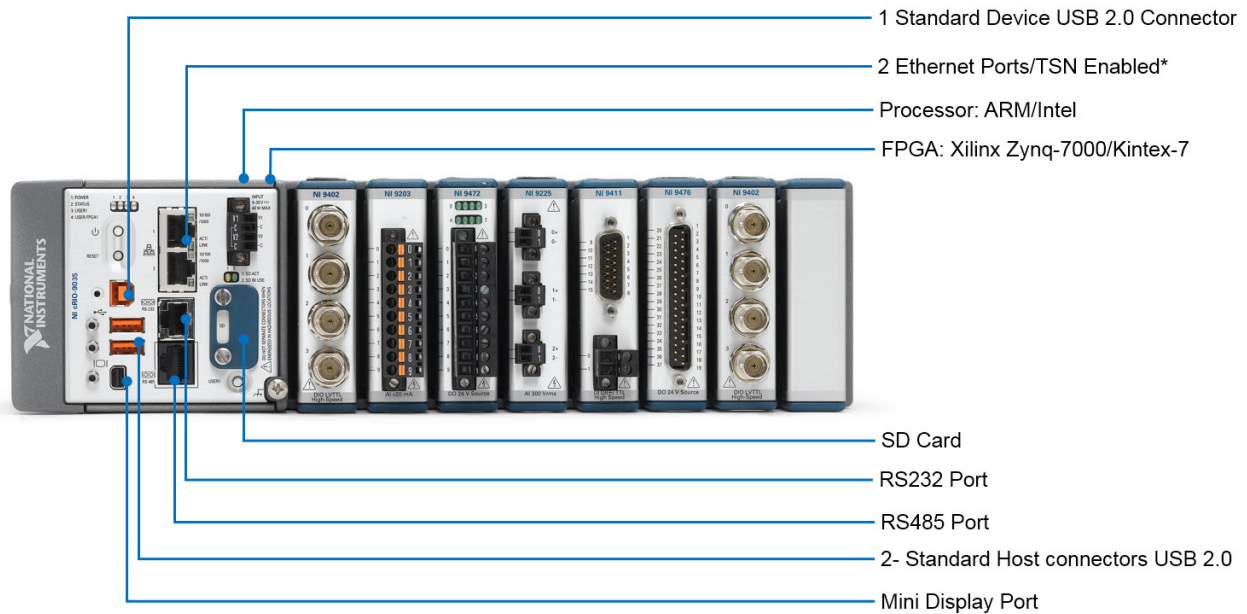

*Only on cRIO-9035/9039 models

Heterogeneous Architecture

CompactRIO Controllers feature a heterogeneous architecture with two processing targets: (1) a real-time processor for communication and signal processing and (2) an FPGA for implementing high-speed control, custom timing and triggering, and signal processing directly in hardware.

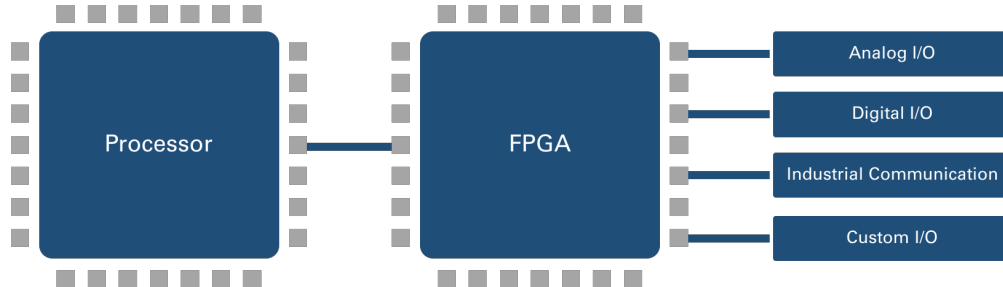

Figure 1. Use the CompactRIO heterogeneous architecture to meet your processing needs.

Processor

The ARM or Intel processor runs NI Linux Real-Time, a real-time OS based on a standard kernel and designed specifically for reliable and deterministic operation in long-term deployments. It includes standard Linux features such as native support for Security-Enhanced Linux for security and reliability.

FPGA

The user programmable FPGA allows you to offload time-critical processes for advanced control, signal processing, filtering, advanced timing, and other logic. NI uses the latest FPGA technology from Xilinx, with chips that contain up to 326,060 logic cells, and 840 DSP slices.

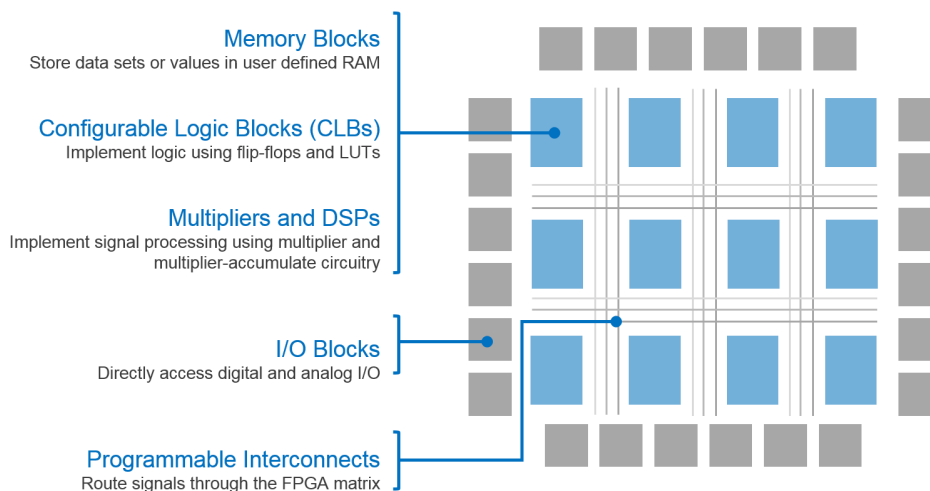

Figure 2. An FPGA contains a matrix of reconfigurable gate array logic circuitry.

Traditional development for FPGA-based systems requires the use of low-level software tools, HDLs, and vendor-specific FPGA implementation toolchains and constraint languages.

The LabVIEW FPGA Module provides a graphical programming approach that simplifies the task of interfacing to I/O and communicating data. It also eliminates the need to think through timing constraints, I/O configuration, and place and route settings.

Integrated Software

Define—and redefine—the functionality of your CompactRIO system with intuitive software, and use a single toolchain for every phase of your design cycle: from modeling and simulation, to prototyping and validation, to deployment and beyond. NI software reduces risk, enhances productivity, and eliminates the need to create and maintain I/O drivers, OSs, and other middleware.

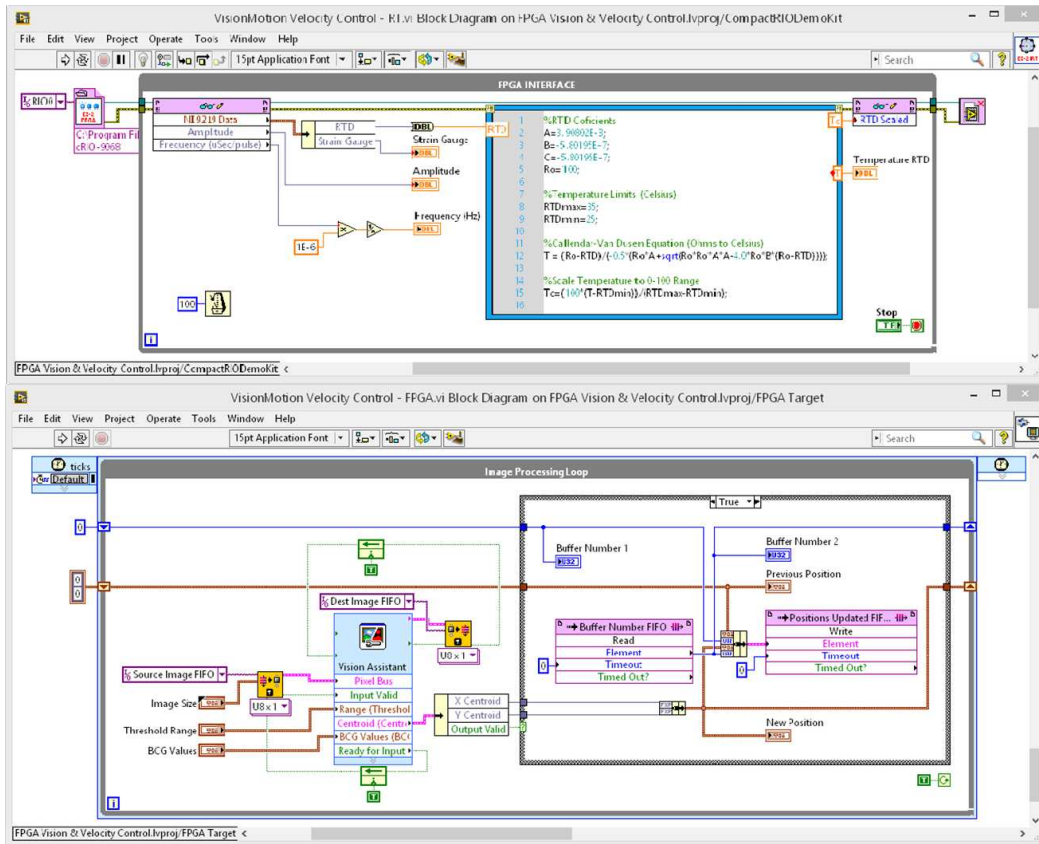

Figure 3. Intuitive and Cohesive Software Programming Environment

Reduced Development Time

Focus on solving problems, not low-level programming tasks, with built-in constructs to manage timing and memory in an intuitive programming environment

Open Software Interoperability

Leverage other programming approaches alongside or within LabVIEW to reuse existing IP and take advantage of existing expertise.

Built-In Libraries

LabVIEW contains nearly 1,000 built-in signal processing, analysis, control, and mathematics functions to accelerate the development of embedded control and monitoring systems.

User-Programmable FPGA

Implement high-speed signal and image processing, custom timing and triggering, and control algorithms directly in hardware to maximize reliability and determinism.

Remote System Management

Transfer data between systems or remotely update hundreds of controllers at once with built-in system management utilities.

LabVIEW Tools Network

Extend the capabilities of your system with a vast ecosystem of certified, application-specific add-ons.

Leverage the Openness of NI Linux Real-Time: A Prebuilt, Validated RTOS

Development Tool Options

Program the real-time processor with LabVIEW, C/C++, or textual math and reuse code from past projects to save development time.

Linux Ecosystem

Access thousands of open-source applications, IP, and examples and collaborate with an active community of users and developers.

Security

Boost security and reliability with native support for Security-Enhanced Linux, which delivers mandatory access control through custom policy creation.

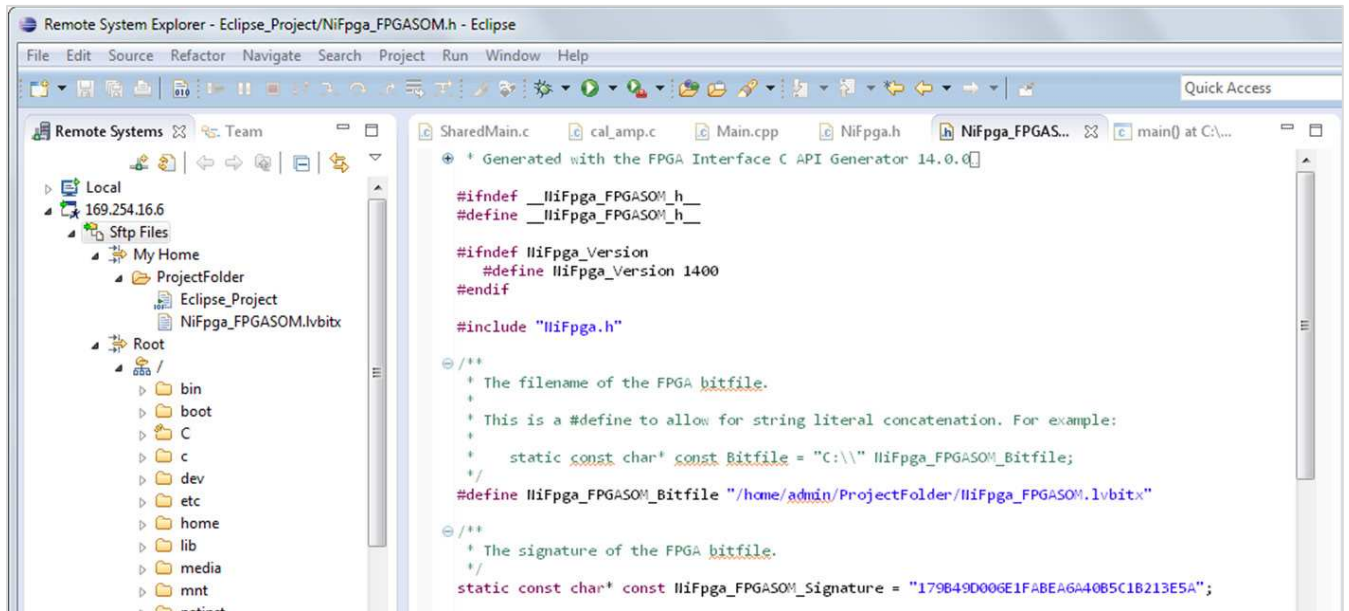

Figure 4. NI Linux Real-Time targets allow you to develop, deploy, and debug C/C++ code using Eclipse or your IDE of choice.

Customize Programmable Hardware With LabVIEW FPGA

Take advantage of the graphical LabVIEW environment to program the onboard FPGA and unlock the incredible power of these devices—even without any knowledge of HDLs like VHDL or Verilog. LabVIEW FPGA removes not only the requirement for HDL programming but also the need to think through timing constraints, I/O configuration, and place and route settings, which are notoriously complex tasks.

- Built-in language constructs to manage clocks/timing, memory, I/O, and data transfer (DMA)
- Cycle-accurate simulation and debugging capabilities
- Support for HDL code integration
- Cloud compile support to reduce compile times
- Access to free IP for complex mathematics, high-speed control, image processing, signal analysis, and more in the FPGA IPNet community

Extensive I/O

Eliminate the need for separate subsystems by connecting components – like motors, cameras, and HMIs– directly to your CompactRIO Controller with built-in I/O such as Gigabit Ethernet, serial, and USB ports and slots for up to eight I/O modules for measurement-specific signal conditioning.

Table 2. Connect to any sensor on any bus with C Series I/O modules.

Signal Type	Channels	Measurement Types	Max Rate	Special Features
Analog Input¹				
Voltage	4, 8, 16, 32	± 200 mV, ± 1 V, ± 5 V, ± 10 V, ± 60 V, 300 V _{rms} , 400 V _{rms} , 800 V _{rms}	1 MS/s/ch	Ch-ch isolation, high-voltage bank isolation, anti-aliasing filters
Current	4, 8, 16	± 20 mA, 5 A _{rms}	200 kS/s	Anti-aliasing filters, ch-ch isolation, built-in shunt resistors
Universal	2, 4	V, mA, TC, RTD, strain, Ω , IEPE	51.2 kS/s/ch	Excitation, bridge completion, anti-aliasing filters, ch-ch isolation, built-in shunt resistors, amplification
Thermocouple	4, 16	J, K, T, E, N, B, R, and S types	75 S/s/ch	CJC, bank isolation, amplification, filtering
RTD	4	100 Ω	400 S/s	50/60 Hz filtering
Strain/Bridge Based	4, 8	1/4, 1/2, full bridge (120 or 350 Ω)	50 kS/s/ch	Excitation, bridge completion, anti-aliasing filters
Acceleration and Sound	3, 4	± 5 V, ± 30 V	102.4 kS/s/ch	IEPE, anti-aliasing filters
Analog Output²				
Voltage	4, 16	± 10 V	100 kS/s/ch	Ch-ch isolation, bank isolation
Current	4	0 mA – 20 mA	100 kS/s/ch	Open-loop detection
Digital I/O				
Input	4, 8, 16, 32	LVTTL, 5 VTTL, 12 V, 24 V, 30 V, 250 VDC/VAC	55 ns	Ch-ch isolation, bank isolation, sinking and sourcing
Output	4, 8, 16, 32	LVTTL, 5 VTTL, 12 V, 24 V, 60 V, 0 V - 50 V programmable	55 ns	Ch-ch isolation, bank isolation, sinking and sourcing
Input/Output	4, 8, 16, 32	LVTTL, 5 VTTL, 12 V, 24 V	55 ns	Ch-ch isolation, bank isolation
Relays	4, 8	30 VDC, 60 VDC, 250 VAC, SPST and SS	1 op/sec	Ch-ch isolation, bank isolation
Specialty				
Motion	1, 1	Step/dir, CW/CCW, analog PWM	-	Stepper and servo drive signals, incremental encoder feedback
Synchronization	1, 3	Cabled, GPS	-	Pulse per second (PPS) accuracy of ± 100 ns for multi-chassis synchronization

¹Up to 24-bit resolution

²Up to 16-bit resolution

Connect directly to industrial cameras and motors to create custom image processing and motion control algorithms. Design interactive, feature-rich GUIs and connect to local, remote, or mobile HMIs for data visualization and operator interfaces.



Figure 5. Simplify system design by connecting directly to cameras, motors, displays, databases, and the enterprise.

Industrial Communications

With native support for common industrial protocols like PROFINET, OPC UA, EtherCAT and more, CompactRIO can connect to a variety of devices, equipment, and infrastructure. Have a brownfield application that requires support for numerous protocols? CompactRIO is an ideal Industrial Internet of Things gateway that can act as the translator between any of the nearly 20 supported protocols, and even custom communication protocols through the FPGA.



Figure 6. CompactRIO Controllers can connect to a variety of brownfield systems via Industrial Communication protocols.

Ruggedness

Contained within a compact, rugged package, CompactRIO Controllers feature operating temperature ranges as wide as -40 °C to 70 °C (-40 °F to 158 °F), up to 50 g shock and 5 g vibration ratings, redundant power supply inputs, and a variety of international safety, Hazloc, and environmental certifications and ratings for operation in harsh industrial environments.



Figure 7. CompactRIO Controllers are certified for use in hazardous locations and multiple countries.

Time Sensitive Networking

Time Sensitive Networking (TSN) is the evolution of standard Ethernet to include time-based synchronization, traffic scheduling, and system configuration. Traffic scheduling and system configuration enable deterministic communication over Ethernet by allowing users to schedule time-critical data across a network.



Figure 8. Three key IEEE 802.1 projects being added to standard Ethernet

TSN is a key enhancement for industrial applications such as process and machine control, for which low communication latency and minimal jitter are critical to meeting closed-loop control requirements. With the ability to schedule traffic across an Ethernet network via system configuration software, you can reliably send both deterministic data and best effort data across a shared Ethernet cable. Time-based synchronization over Ethernet also minimizes the cabling traditionally found in physical systems test and monitoring applications to offer a cleaner and more cost-effective solution.

Take advantage of TSN today with three released TSN-enabled NI products: CompactRIO Controller with TSN, Ethernet CompactDAQ Chassis with TSN, and the Industrial Controller with TSN. Find these TSN enabled products by looking for the “Synchronization” attribute in Shop.

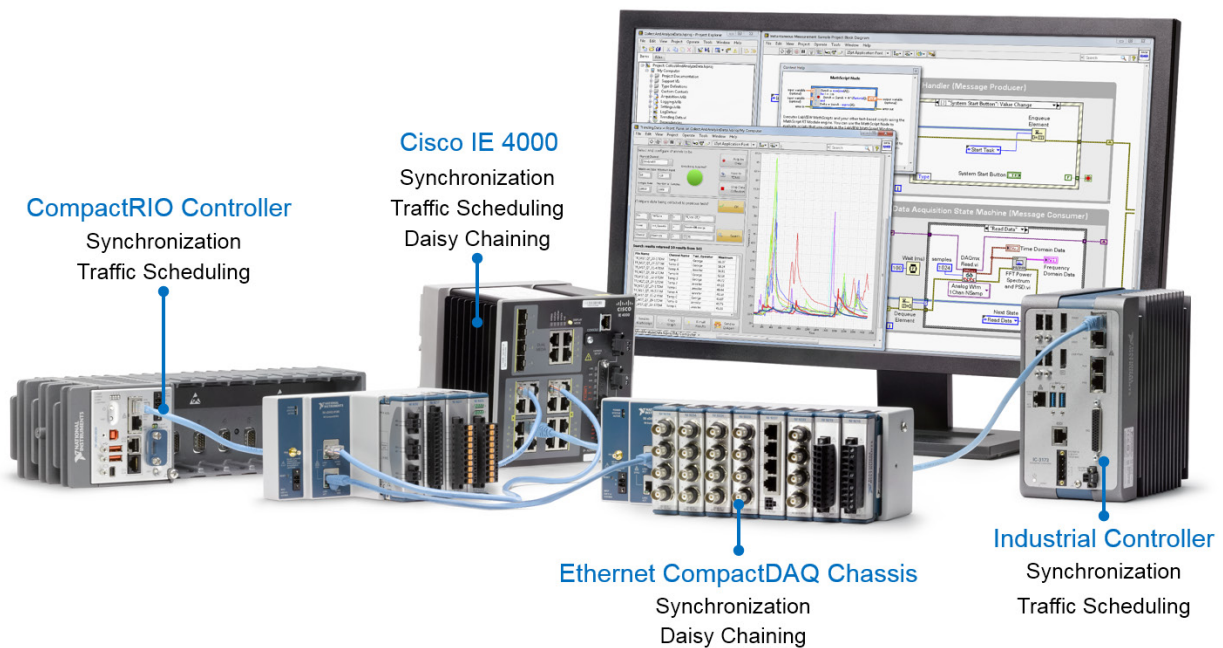

Figure 9. TSN-Enabled Products From NI and Technology Partners

Platform-Based Approach to Control and Monitoring

What is the CompactRIO Platform?

Every CompactRIO device is built on three pillars: productive software, reconfigurable hardware, and an expansive ecosystem. This results in a hardware platform that allows your business to standardize, customize, and accelerate productivity.

NI's integrated run-time software, development environments, IP libraries, drivers, middleware, and enterprise and systems management tools, along with high-quality hardware and global services and support, provide the capabilities to meet your business needs.

Software

Take advantage of NI Linux Real-Time using LabVIEW or C/C++. Simplify FPGA programming using LabVIEW FPGA.

Modules

Over 200+ IO types supported by the CompactRIO family.



Form Factor



Choose between packaged and board-level controllers

Integration

Supports expansion I/O, vision, motion, industrial communication protocols, and HMIs

Monetize Your Efforts

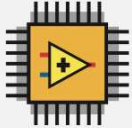
Focus on the core expertise of your business while leaving the foundational elements of your embedded design to NI. Spend time delivering innovation, competitive differentiation, and value add features to your customers by customizing a pre-built, pre-validated embedded system from NI. Get your equipment or machines shipping faster, with less engineering expense and risk, and more features

<p>DETERMINISTIC CONTROL</p> 	<p>USER PROGRAMMABLE FPGA</p> 	<p>ANY SENSOR, ANY BUS</p> 	<p>RUGGED ENVIRONMENTS up to</p> <p>50g shock</p> <p>5g vibration</p>
--	---	---	---

Hardware Services

All NI hardware includes a one-year warranty for basic repair coverage, and calibration in adherence to NI specifications prior to shipment. PXI systems also include basic assembly and a functional test. NI offers additional entitlements to improve uptime and lower maintenance costs with service programs for hardware. Learn more at ni.com/services/hardware.

	Standard	Premium	Description
Program Duration	1, 3, or 5 years	1, 3, or 5 years	Length of service program
Extended Repair Coverage	•	•	NI restores your device's functionality and includes firmware updates and factory calibration.
System Configuration, Assembly, and Test ¹	•	•	NI technicians assemble, install software in, and test your system per your custom configuration prior to shipment.
Advanced Replacement ²		•	NI stocks replacement hardware that can be shipped immediately if a repair is needed.
System Return Material Authorization (RMA) ¹		•	NI accepts the delivery of fully assembled systems when performing repair services.
Calibration Plan (Optional)	Standard	Expedited ³	NI performs the requested level of calibration at the specified calibration interval for the duration of the service program.

¹This option is only available for PXI, CompactRIO, and CompactDAQ systems.

²This option is not available for all products in all countries. Contact your local NI sales engineer to confirm availability.

³Expedited calibration only includes traceable levels.

PremiumPlus Service Program

NI can customize the offerings listed above, or offer additional entitlements such as on-site calibration, custom sparring, and life-cycle services through a PremiumPlus Service Program. Contact your NI sales representative to learn more.

Technical Support

Every NI system includes a 30-day trial for phone and e-mail support from NI engineers, which can be extended through a [Software Service Program \(SSP\)](#) membership. NI has more than 400 support engineers available around the globe to provide local support in more than 30 languages. Additionally, take advantage of NI's award winning [online resources](#) and [communities](#).

©2017 National Instruments. All rights reserved. CompactRIO, LabVIEW, National Instruments, NI, ni.com, and NI CompactDAQ are trademarks of National Instruments. The registered trademark Linux® is used pursuant to a sublicense from LMI, the exclusive licensee of Linus Torvalds, owner of the mark on a worldwide basis. Other product and company names listed are trademarks or trade names of their respective companies. The contents of this Site could contain technical inaccuracies, typographical errors, or out-of-date information. Information may be updated or changed at any time, without notice. Visit ni.com/manuals for the latest information.

27 December 2017