

COMPREHENSIVE SERVICES

We offer competitive repair and calibration services, as well as easily accessible documentation and free downloadable resources.

SELL YOUR SURPLUS

We buy new, used, decommissioned, and surplus parts from every NI series. We work out the best solution to suit your individual needs.

 Sell For Cash  Get Credit  Receive a Trade-In Deal

OBSOLETE NI HARDWARE IN STOCK & READY TO SHIP

We stock **New**, **New Surplus**, **Refurbished**, and **Reconditioned** NI Hardware.



Bridging the gap between the manufacturer and your legacy test system.

 1-800-915-6216

 www.apexwaves.com

 sales@apexwaves.com

All trademarks, brands, and brand names are the property of their respective owners.

Request a Quote

 **CLICK HERE**

FD-11605

FD-11605

8-Channel, ± 60 V Voltage Input Device for FieldDAQ

The FieldDAQ FD-11605 is an IP65/IP67-rated eight-channel high-voltage simultaneous voltage input device. It can be networked and synchronized with IEEE 802.1AS devices.

Figure 1. FD-11605 Front Panel

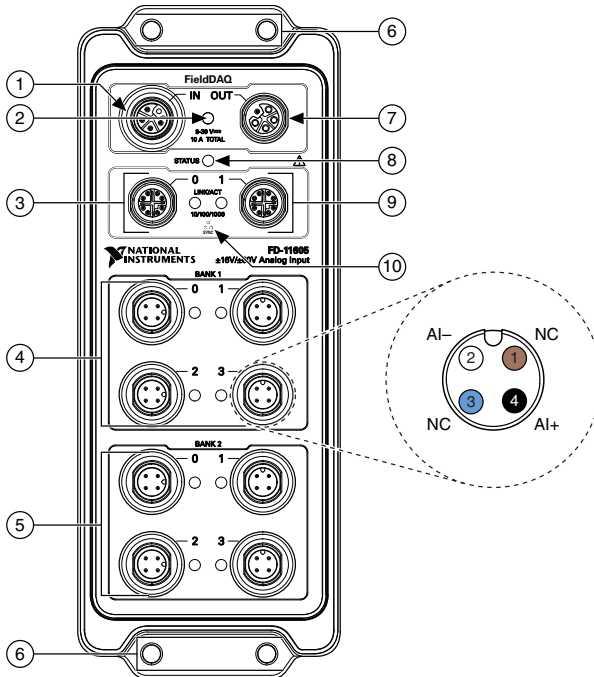

- | | |
|---|----------------------------|
| 1. Power IN Connector | 6. Mounting Holes |
| 2. Power LED | 7. Power OUT Connector |
| 3. Ethernet Port 0 and LED | 8. STATUS LED |
| 4. Bank 1 Voltage Input Connectors 0 through 3 and LEDs | 9. Ethernet Port 1 and LED |
| 5. Bank 2 Voltage Input Connectors 0 through 3 and LEDs | 10. SYNC Logo |

Contents

FD-11605 Basic Information.....	3
Safety Guidelines.....	4
Safety Guidelines for Hazardous Voltages.....	5
EMC Guidelines.....	5
Electromagnetic Compatibility Notices.....	5
Special Conditions for Marine Applications.....	6
Unpacking.....	6
Hardware Symbol Definitions.....	6
What You Need to Get Started.....	7
Setting up the FieldDAQ Device.....	7
Power Connectors and Wiring.....	11
Power Connectors.....	12
Power LED.....	13
Wiring External Power to the FieldDAQ Device.....	13
Voltage Input Connectors and Measurements.....	14
Voltage Input Connectors.....	15
Voltage Input LEDs.....	18
Connecting Voltage Input Signals.....	19
Filtering.....	19
Data Rates.....	24
Programming the FieldDAQ Device.....	25
Time-Based Triggers.....	26
Timebases.....	27
Synchronization across a Network.....	27
More Information about Synchronization.....	28
Ethernet Ports and Networking.....	28
Ethernet Ports.....	28
Ethernet LEDs.....	29
Internal Ethernet Switch.....	30
Topology Options.....	31
External Switch Requirements.....	34
Connecting to a Real-Time Controller.....	35
Troubleshooting Device Connectivity.....	39
Reserving the Device in MAX.....	39
STATUS LED.....	39
Resetting the FieldDAQ to Factory-Default Settings.....	40
Mounting.....	41
Mounting Requirements.....	43
Dimensions.....	45
Mounting the Device Directly on a Flat Surface.....	45
Alternate Mounting Configurations.....	47
Firmware.....	49

Maintenance.....	49
Where to Go from Here.....	50
Example Programs.....	50
Related Documentation.....	50
Training Courses.....	52
Technical Support on the Web.....	52

FD-11605 Basic Information

Kit Contents

Items in your FieldDAQ kit:

- FD-11605
- *FD-11605 Quick Start*
- *FD-11605 Safety, Environmental, and Regulatory Information*
- 9 M12 female caps for power IN and input connectors (connected to device)
- 3 M12 male caps for power OUT and Ethernet connectors (connected to device)

Pinouts

Refer to the following topics for the connector pinouts on your FieldDAQ device:

- Voltage input connector pinout: Refer to [Voltage Input Connectors](#) on page 15.
- Ethernet connector pinout: Refer to [Ethernet Ports](#) on page 28.
- Power connector pinout: Refer to [Power Connectors](#) on page 12.

Driver Support

Earliest driver support version for your FieldDAQ device:

Table 1. FD-11605 Driver Support

Driver	Earliest Version Support
NI-DAQmx	19.0

Cables and Accessories

The following table lists some cables and accessories available for your FieldDAQ device. For a complete list of FieldDAQ accessories and ordering information, refer to the pricing section of the FD-11605 product page at ni.com.

Table 2. FD-11605 Cables and Accessories

Cable/Accessory	Part Number
IP67 Power Supply	147464-01
PS-16 Power Supply	781094-01

Table 2. FD-11605 Cables and Accessories (Continued)

Cable/Accessory	Part Number
M125F-Pigtail Power Cable (1 m, 2 m, 3 m lengths)	786172-01/02/03
M125F-M125M Power Cable (0.3 m, 1 m, 2 m lengths)	786173-0R3/01/02
SHM128M-RJ45 Ethernet Cable (1 m, 2 m, 3 m, 10 m lengths)	785944-01/02/03/10
SHM128M-SH128M Ethernet Cable (0.3 m, 1 m, 3 m lengths)	785946-0R3/01/03
SHM124F-Pigtail I/O Cable (0.3 m, 1 m, 3 m, lengths)	786895-0R3/01/03
FD-11954, M124M Field-serviceable I/O Connector	786894-01
M12 Torque Wrench, Ethernet	786181-01
M12 Torque Wrench, Power	786182-01
M12 Torque Wrench, Hazardous Live I/O	787008-01
Universal M12 Male Cap, Plastic	786177-01
Universal M12 Male Cap, Metal	786178-01
Universal M12 Female Cap, Plastic	786180-01
Universal M12 Female Cap, Metal	786179-01
FD-11960, DIN Rail Mounting Kit	786443-01

FD-11605 Documentation

Documents that contain information about your FieldDAQ device:

- *FD-11605 Specifications*
- *FD-11605 Quick Start*
- *FD-11605 Safety, Environmental, and Regulatory Information*

Safety Guidelines



Caution Do not operate the FD-11605 in a manner not specified in this user guide. Product misuse can result in a hazard. You can compromise the safety protection built into the product if the product is damaged in any way. If the product is damaged, return it to NI for repair.

The FD-11605 is rated for use in DRY or WET LOCATIONS.

Safety Guidelines for Hazardous Voltages

If hazardous voltages are connected to the device, take the following precautions. A hazardous voltage is a voltage greater than 42.4 V peak voltage or 60 V DC in DRY LOCATIONS, and 22.6 V peak or 35 V DC in WET LOCATIONS.



Caution Ensure that hazardous voltage wiring is performed only by qualified personnel adhering to local electrical standards.



Caution Do not mix hazardous voltage circuits and human-accessible circuits on the same device.



Caution When device terminals are hazardous voltage LIVE, you must ensure that devices and circuits connected to the device are properly insulated from human contact.



Caution All wiring must be insulated for the highest voltage used.

EMC Guidelines

This product was tested and complies with the regulatory requirements and limits for electromagnetic compatibility (EMC) stated in the product specifications. These requirements and limits provide reasonable protection against harmful interference when the product is operated in the intended operational electromagnetic environment.

This product is intended for use in industrial locations. However, harmful interference may occur in some installations, when the product is connected to a peripheral device or test object, or if the product is used in residential or commercial areas. To minimize interference with radio and television reception and prevent unacceptable performance degradation, install and use this product in strict accordance with the instructions in the product documentation.

Furthermore, any changes or modifications to the product not expressly approved by NI could void your authority to operate it under your local regulatory rules.

Electromagnetic Compatibility Notices

Refer to the following notices for cables, accessories, and prevention measures necessary to ensure the specified EMC performance.



Notice To ensure the specified EMC performance, operate this product only with shielded cables and accessories.

Special Conditions for Marine Applications

Some models are approved for marine (shipboard) applications. To verify marine approval certification for a model, visit ni.com/product-certifications, search by model number, and click the appropriate link.



Notice In order to meet the EMC requirements for marine applications, install the model in a shielded enclosure with shielded and/or filtered power and input/output ports. In addition, take precautions when designing, selecting, and installing measurement probes and cables to ensure that the desired EMC performance is attained.

Unpacking

The FD-11605 ships in an antistatic package to prevent electrostatic discharge (ESD). ESD can damage several components on the device.



Notice Never touch the exposed pins of connectors.

To avoid ESD damage in handling the device, take the following precautions:

- Ground yourself with a grounding strap or by touching a grounded object.
- Touch the antistatic package to a metal part of your computer chassis before removing the device from the package.

Remove the device from the package and inspect it for loose components or any other signs of damage. Notify NI if the device appears damaged in any way. Do not install a damaged device.

Store the device in the antistatic package when the device is not in use.

Hardware Symbol Definitions

The following symbols are marked on your FieldDAQ device.



When this symbol is marked on a product, refer to [Safety Guidelines](#) for information about precautions to take.



At the end of the product life cycle, all NI products must be disposed of according to local laws and regulations. For more information about how to recycle NI products in your region, visit ni.com/environment/weee.



中国客户 National Instruments 符合中国电子信息产品中限制使用某些有害物质指令 (RoHS)。关于 National Instruments 中国 RoHS 合规性信息, 请登录 ni.com/environment/rohs_china。(For information about China RoHS compliance, go to ni.com/environment/rohs_china.)

What You Need to Get Started

You will need the following items to set up your FieldDAQ device.

Figure 2. FD-11605 Installation Supply List

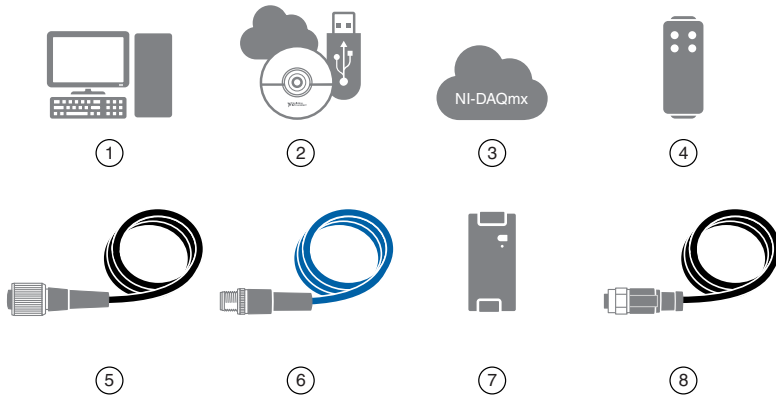

1. Host Computer running Windows or NI Linux RT
2. Application Software
3. NI-DAQmx Driver
4. FD-11605
5. 5-pin L-coded M12 Power Input Cable
6. 8-pin X-coded M12 Ethernet Cable
7. External Power Supply
8. 4-pin A-coded M12 Voltage Input Cables and Accessories



Note You can either use a shielded straight-through Ethernet cable or an Ethernet crossover cable to connect the FieldDAQ device directly to your computer.

Setting up the FieldDAQ Device

Complete the following steps.

1. Install the application software (if applicable), as described in the installation instructions that accompany your software. Check your driver and application development environment (ADE) readme files for specific version compatibility.
2. Install NI-DAQmx from ni.com/downloads/drivers. Complete the instructions.
3. Register your NI hardware online at ni.com/register when prompted. The last dialog box opens with the following options:
 - **Restart Later** to install more NI software or documentation.
 - **Shut Down or Restart** if you are ready to install your device.

If you have problems installing your software, go to ni.com/support/daqmx.

4. (Optional) Mount the FieldDAQ device to a panel or DIN rail, as described in [Mounting](#).

5. Make voltage input connections. Refer to *Voltage Input Connectors and Measurements* for information about signal connections and guidelines.
6. Align and connect one end of the Ethernet cable to Ethernet port 0 on the device, and the other end directly to your computer or any network connection on the same subnet as your computer.
7. Power the device by aligning and connecting the power IN port on FieldDAQ to an external 9 V DC to 30 V DC power source with the 5-pin L-coded M12 power cable. For information about wiring your external power source to the power connector, refer to *Wiring External Power to the FieldDAQ Device*. The FieldDAQ device requires an external power supply that meets the specifications listed in the *FD-11605 Specifications*.

The Power LED turns on. Refer to *Power LED* for information about Power LED status.

8. To add the FieldDAQ to your software configuration, open NI MAX on your Windows host computer. Expand **Devices and Interfaces»Network Devices**.
 - If the device is on your local subnet, the device automatically appears in the list of available devices. Right-click the FieldDAQ device and select **Add Device**.
 - If the device is not on your local subnet, right-click **Network Devices** and select **Find Network NI-DAQmx Devices**.
 1. In the Find Network NI-DAQmx Devices dialog box that opens, do one of the following:
 - Check the box that corresponds to your device in the Hostname column.

Figure 3. Find Network NI-DAQmx Devices

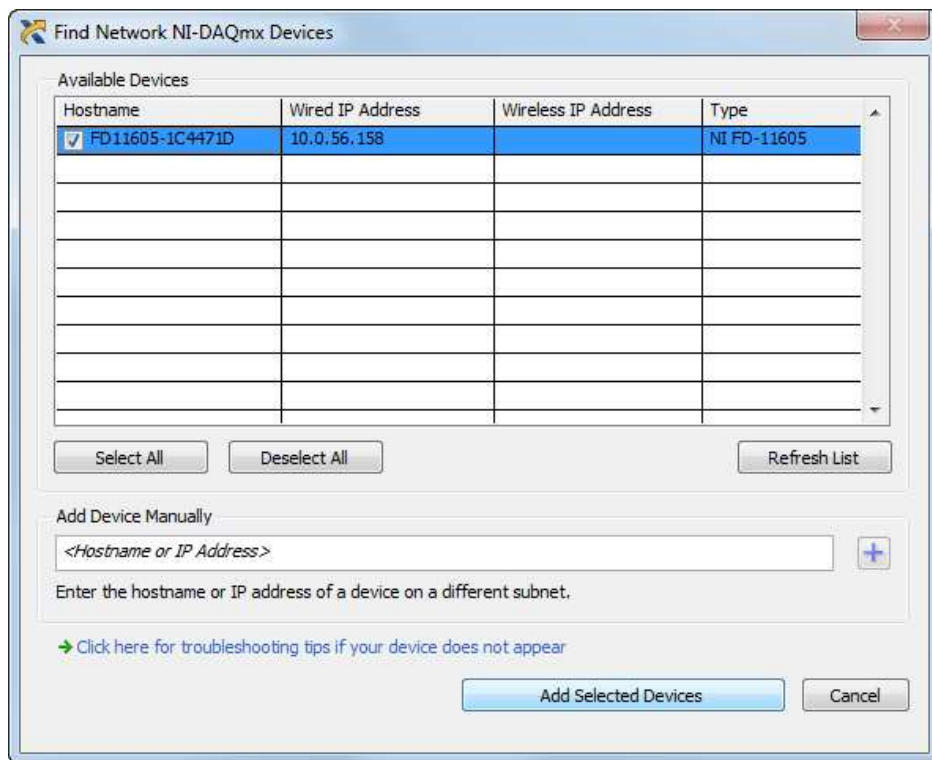

- If you know the device IP address, such as 192.168.0.2, enter it into the **Add Device Manually** field of the Find Network NI-DAQmx Devices window, and click the + button.
 - Enter the hostname of the device. The default hostname is FD11605-*<serial number>*.
2. Click **Add Selected Devices**.

The FieldDAQ device icon changes from white to dark grey, indicating that it is recognized and present on the network.

Figure 4. MAX Icons and States



1. Discovered, but Not Added to the Network
2. Recognized, Present, and Reserved on the Network
3. Recognized, but Disconnected from the Network, Unreserved, or Reserved by Another Host

If your device does not appear in Available Devices, click **Refresh List**. If the device still does not appear, try the following:

- If you connected the FieldDAQ device directly to your computer, ensure your network card is configured to obtain an IP address automatically, then click **Refresh List**.



Note If you connected the FieldDAQ device directly to your computer, the setup time may be longer. Wait 30 to 60 seconds after the STATUS LED turns off, then click **Refresh List**.

- Contact your system administrator to confirm that the network is working and that a firewall is not interfering with discovery. For additional troubleshooting resources for the FieldDAQ device, refer to the [Troubleshooting Device Connectivity](#) in this guide and the *Finding a Network DAQ Device in MAX* topic in the *Measurement & Automation Explorer Help for NI-DAQmx*.

Figure 5. Network Devices in MAX

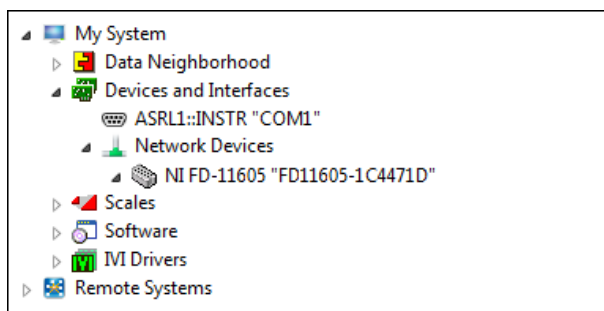

9. If the FieldDAQ device is not reserved automatically, select the device and click the **Reserve Network Device** button. Refer to [Reserving the Device in MAX](#) for more information.
10. Self-test your device in MAX by expanding **Devices and Interfaces»Network Devices**, right-clicking your FieldDAQ device, and selecting **Self-Test**. Self-test performs a brief

test to determine successful device installation. When the self-test finishes, a message indicates successful verification or if an error occurred. If an error occurs, refer to ni.com/support/daqmx.

11. Run a Test Panel in MAX by expanding **Devices and Interfaces»Network Devices»your FieldDAQ device**, right-clicking the bank of connectors in your FieldDAQ device, and selecting **Test Panels**. If the test panel displays an error message, refer to ni.com/support. Click **Close** to exit the test panel.



Note When in use, the FieldDAQ device may become warm to the touch. This is normal.



Note M12 connectors must be mated to cables or have caps installed on them to meet IP65/IP67 requirements. Cover the unused connectors with the included plastic caps whenever water, dust, or dirt are present.



Note Avoid long periods of exposure to sunlight.

For instructions on networking to a real-time controller, refer to [Connecting to a Real-Time Controller](#).

Power Connectors and Wiring

The FieldDAQ device has two 5-pin L-coded M12 power connectors, power IN and power OUT. The power connectors provide one voltage line (V), one common line (C), chassis ground, and two lines for optional auxiliary power, Aux1 and Aux2.

The following figure shows the power circuitry on the FieldDAQ device.

Figure 6. Power Circuitry

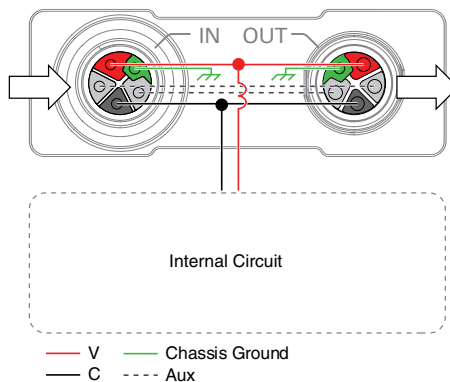

The FieldDAQ device requires an external power source connected between the V and C terminals, as described in *Power Requirements* in the *FD-11605 Specifications*. The FieldDAQ

device internally connects the C terminal to the chassis ground. Recommended NI power supplies are listed in [FD-11605 Basic Information](#).

The FD-11605 has a maximum device power consumption of 6 W. Each FieldDAQ filters and regulates the supplied power for its tasks.

When FieldDAQ devices are linked together through the power IN and power OUT connectors, the total current consumption of the chain equals the sum of every linked FieldDAQ device’s current consumption. The total current cannot exceed 10 A, and the total supply load of the chain must be less than 300 W.

You can use the optional auxiliary power lines (Aux1 and Aux2) to draw power for non-FieldDAQ devices in your network. The FieldDAQ device does not make use of the auxiliary power itself. If you are connecting power through the auxiliary power lines, ensure that the total combined current between V Input and Aux power lines does not exceed 10 A.

Refer to the *FD-11605 Specifications* for information about the power connectors, power requirements, and current limits of your FieldDAQ device.

Cap the power connectors when not in use.

Power Connectors

The following figure shows the pinout of the Power IN connector.

Figure 7. Power Connector Pinout

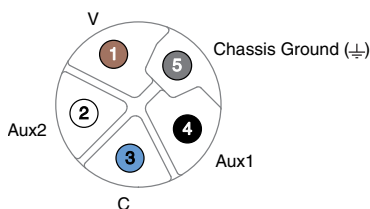



Table 3. Signal Descriptions

Pin Number	Wire Color*	Signal	Description
1	Brown	V	Positive voltage line
2	White	Aux2	Optional line for powering non-FieldDAQ devices
3	Blue	C	Common. Negative voltage line
4	Black	Aux1	Optional line for powering non-FieldDAQ devices

Table 3. Signal Descriptions (Continued)

Pin Number	Wire Color*	Signal	Description
5	Gray		Chassis Ground. This terminal is internally connected to the C terminal.
* Wire color pertains to M125F power cables sold through NI. Other manufacturers' cable wire colors may vary.			

Power LED

The green POWER LED on the front panel identifies when the device is powered.

Table 4. LED State/Device Status

LED State	Device Status
On	Device is receiving adequate power for its tasks.
Off	Device is unpowered or receiving inadequate power.

Wiring External Power to the FieldDAQ Device

Complete the following steps to connect a power source to the FieldDAQ device.

1. Verify the power source is turned off.
2. If you are not using a pre-assembled cable, complete the following steps.
 - a. Connect the positive lead of the primary power source to the V terminal (pin 1) inside the power connector plug.
 - b. Connect the negative lead of the primary power source to the C terminal (pin 3) inside the power connector plug.
 - c. Connect the Chassis Ground terminal (pin 5) inside the power connector plug to earth ground. This terminal is internally connected to the C terminal.
 - d. (Optional) To power non-FieldDAQ devices through the power network, connect the leads of an additional auxiliary power source to the Aux1 (pin 4) and Aux2 (pin 2) terminals inside the power connector plug.
 - e. Assemble the rest of the plug sleeve.
3. Carefully align and connect the cable to the external power source and the power IN connector on the FieldDAQ device.
4. Turn on the external power source.

If the power source is connected to the power connector using long wiring with high DC resistance, the voltage at the power connector may be significantly lower than the specified voltage of the power source.

Refer to *Power Requirements* in the *FD-11605 Specifications* for information about the power supply input range. Refer to *Safety Voltages* in the *FD-11605 Specifications* for information about the maximum voltage from terminal to chassis ground.

Voltage Input Connectors and Measurements

The following figures show voltage input circuitry and block diagram of the FD-11605.

Figure 8. FD-11605 Input Circuitry

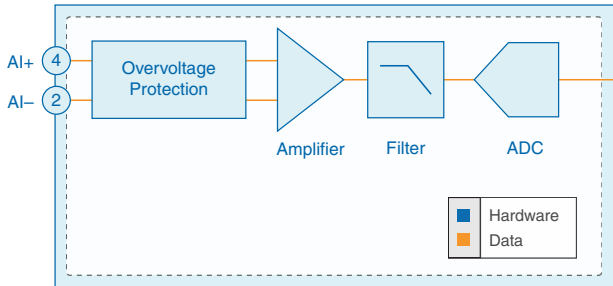
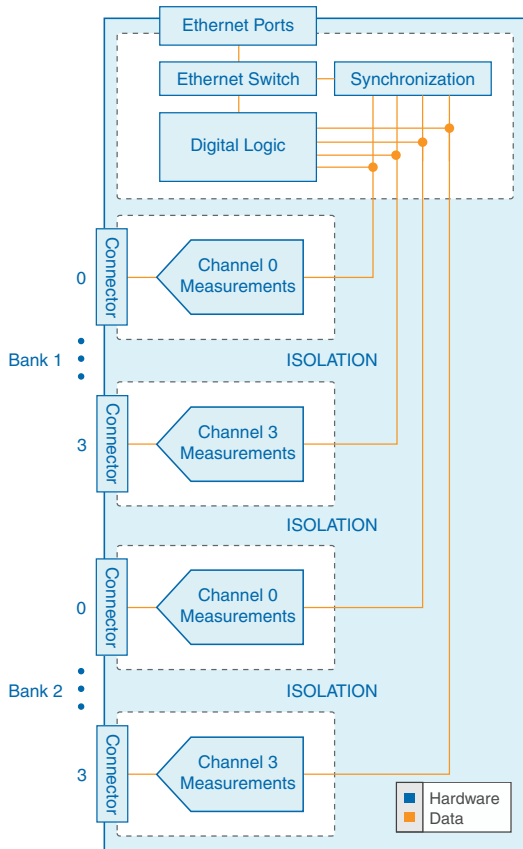

Figure 9. FD-11605 Block Diagram



The FD-11605 provides channel-to-channel isolation. Input signals on each channel are conditioned, buffered, and then sampled by an ADC. Each AI channel provides an independent signal path and ADC, enabling you to sample all channels simultaneously. The FieldDAQ device provides overvoltage protection for each channel; refer to the *FD-11605 Specifications* for more information about overvoltage protection.

Voltage Input Connectors

The FD-11605 features eight 4-pin A-coded M12 connectors: Bank 1 connectors 0 through 3 and Bank 2 connectors 0 through 3. The following figure shows the pinout of a voltage input connector.

Figure 10. FD-11605 Pinout

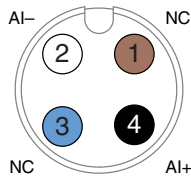

Table 5. Signal Descriptions

Pin Number	Wire Color*	Signal	Description
1	Brown	NC	No connect. Do not connect signals to this terminal.
3	Blue	NC	
2	White	AI-	Negative analog input voltage signal
4	Black	AI+	Positive analog input voltage signal

* Wire color pertains to SHM124F I/O cables sold through NI. Other manufacturers' cable wire colors may vary.



Note M12 connectors must be mated to cables or have caps installed on them to meet IP65/IP67 requirements. Cover the unused connectors with the included plastic caps whenever water, dust, or dirt are present.

Assembling the FD-11954 Field Serviceable Connector

The FD-11954 (part number 785894-01) is a field terminable I/O connector you can attach to unterminated (pigtail) cables for use with the 4-pin high-voltage FD-11605 device. The kit contains one 4-pin field terminal connector and conductive tape.



Notice Do not unscrew the interior wire holder from the end cap.

Complete the following steps to set up the FD-11954.

1. On the cable, use wire strippers to remove 80 mm (3.14 in.) of the cable jacket. Strip cable shield such that it extends approximately 6 mm (0.2 in.) from the end of the jacket. Do not strip the signal wires.
2. Prepare the exposed shield for your cable.

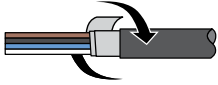
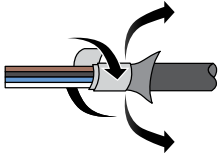
Cable Diameter	Instructions	Diagram
6 mm–9.7 mm (0.24 in.–0.34 in.)	Wind the conductive tape around the exposed shield.	
5 mm–6 mm (0.2 in.–0.24 in.)	Fold the exposed shield over the jacket and wind the conductive tape around the exposed shield.	

3. Feed the cable wiring through the hexagonal end of the cable-side of the connector until it bottoms out. The conductive tape makes contact with the interior of the connector.

Figure 11. Inserting the Cable

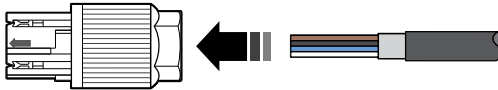

4. Align each signal wire with its color-coded channel inside of the connector. Take care to distinguish the white slot for terminal 2 (AI-) from the uncolored, unused slot adjacent clockwise to it.
5. Bend the wires out of the connector, guiding them through the appropriate slot to lock in place.

Figure 12. Cable-Side Connections

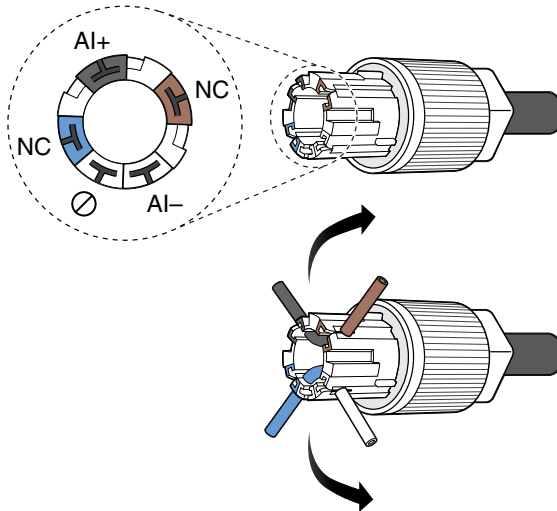

6. Use a side cutter to cut the exposed signal wires flush with the connector.

Figure 13. Cutting the Signal Wires

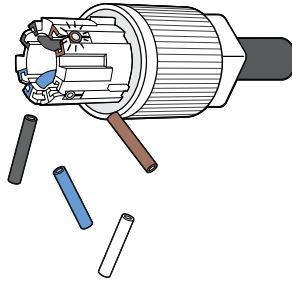

7. Align the arrows on both ends of the connector to reattach. Screw both ends together to a torque of $5 \text{ N} \cdot \text{m}$ ($44.25 \text{ lb} \cdot \text{in.}$) with a 15 mm wrench.

Figure 14. Reattaching the Connector

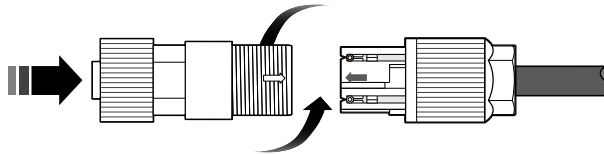

8. Connect your cable to the voltage input connector on your FieldDAQ device with a torque of $0.6 \text{ N} \cdot \text{m}$ ($5.31 \text{ lb} \cdot \text{in.}$).

Voltage Input LEDs

Each voltage input connector has a yellow LED.

Table 6. LED State/Status

LED State	Connector Status
Off	Normal operation
Blinking	User-defined status. Use MAX to write a state to any LED by expanding Devices and Interfaces»Network Devices»your FieldDAQ device»bank of connectors in your FieldDAQ device and configuring the LED settings on the Settings tab.



Note You cannot configure an LED while a task is running.

Connecting Voltage Input Signals

You can connect grounded and floating voltage input signals to the FieldDAQ device. Make sure that devices you connect to the FieldDAQ device are compatible, as listed in the *FD-11605 Specifications*.

- **Grounded Signal Sources**—To ensure proper operation, make sure the voltage on the AI+ and AI- connections adhere to the channel-to-earth ground safety voltage specifications listed in the *FD-11605 Specifications*.

Figure 15. Connecting Grounded Signal Sources to the FieldDAQ Device

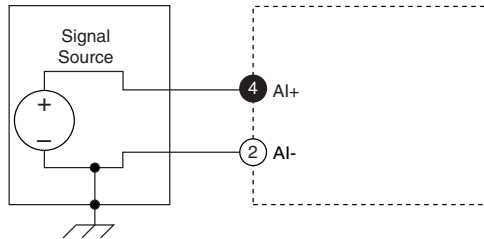

- **Floating Signal Sources**

Figure 16. Connecting Floating Signal Sources to the FieldDAQ Device

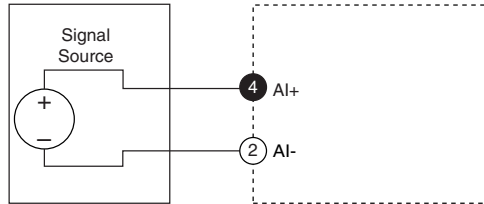

Filtering

You can configure a filter for each bank on the FieldDAQ device. FieldDAQ supports three types of lowpass filtering:

- Brickwall (default)
- Butterworth
- Comb

Table 7. Comparing FieldDAQ Filters

Attribute	Brickwall (Default)	Butterworth	Comb
Passband	Tracks sample rate	Configurable independent of sample rate	Tracks sample rate
Alias Protection	Best—Full protection	Better—Configurable protection level	Good—Partial protection
Latency	High	Medium to high (configuration-dependent)	Low
Input Delay Variation versus Frequency	Constant input delay	Variable input delay	Constant input delay
Flatness	Best	Best	Good
Step Response (Time Domain)	Most delay, ringing (overshoot/undershoot)	Mid-level delay, overshoot	Short delay, no overshoot/undershoot
Typical Applications	Analyzing dynamic properties of signals Analyzing spectrum of signals	Filtering out specific noise sources Analyzing signals in the time domain Reducing measurement noise	Filtering out specific noise sources Analyzing signals in the time domain Control applications

Refer to the *FD-11605 Specifications* for details on the amount of variation in the response you can expect for different input frequency ranges.

Frequency Response of FieldDAQ Filters

The FieldDAQ device uses a combination of analog and digital filtering to provide an accurate representation of in-band signals and reject out-of-band signals. The filters discriminate between signals based on the frequency range, or bandwidth, of the signal. How the filter discriminates signals based on their frequency is known as frequency response. In general, the frequency response of a filter is described by a signal attenuation (magnitude response) and an input delay (phase response) for every input frequency.

- **Magnitude Response**—The three important frequency ranges, or bandwidths, to consider for magnitude response are passband, transition band, and stopband:

Figure 17. Example Magnitude Response of a Lowpass Filter

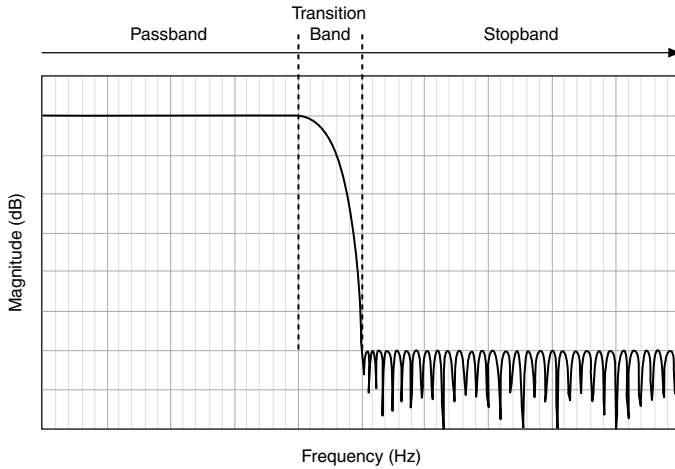

- Passband—The range of frequencies at which the filter attempts to pass a signal without modifying it. The small amount of variation in magnitude at these frequencies is called passband flatness. This is the frequency range of signals that you want to measure.
- Transition band—The range of frequencies in which the filter magnitude response has started to roll-off such that it attenuates signals by some amount, but has not reached the full attenuation amount. The shape of the transition band has an impact on the alias rejection and how signals are represented in the time domain (for example, step response).
- Stopband—The range of frequencies at which the filter attenuates input signals to its maximum attenuation level. Ideally, you want to choose a filter with a stopband that covers frequencies of noise sources that you do not want in your measurements.
- **Phase Response (Input Delay)**—Filters delay the input signal by some amount when processing data. In some cases, the delay is a function of the input signal frequency; when this is the case, the phase response plot is useful for knowing the exact delay at different input frequencies and the maximum variation between signals of different frequencies within the passband. Call the `AI.FilterDelay` property in `NI-DAQmx` to read the input delay.

Figure 18. Example Input Delay of a Lowpass Filter

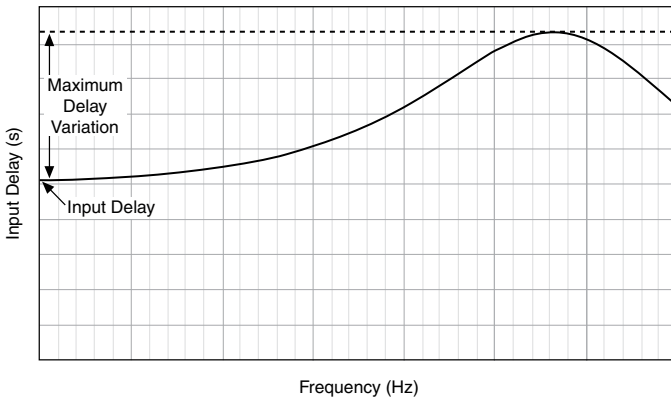

Each FieldDAQ filter has a different frequency response to serve different applications:

- **Brickwall**—Has a passband that extends to approximately 0.4 times the sampled data rate, then drops with a very sharp transition band to reach the stopband and properly reject any alias components or noise that may exist. The brickwall filter is designed to provide full alias protection from any signal component of more than one-half the sampled data rate (Nyquist frequency).
- **Butterworth**—Has a passband independent of the sampling rate (as opposed to the brickwall and comb filters), which offers more flexibility when filtering out noise that is below one-half of the sample rate. However, depending on your settings, you may see alias components of higher frequency signals in your measurement that extend beyond one-half of the sample rate due to the larger transition band.
- **Comb**—Has a smaller passband because its transition band starts early in the frequency range. The comb filter has shorter group delay than other filters and better representation of signals in the time domain (step response). The passband and transition band notches track the data sample rate similar to the brickwall filter. The comb filter's transition band features equally-spaced notches at different frequencies. It is common to use the comb filter with a specific sample rate to align the notches of the transition band thereby removing a specific noise-source frequency from measurements.

Figure 19. Comparing Typical Magnitude Response of FieldDAQ Filters

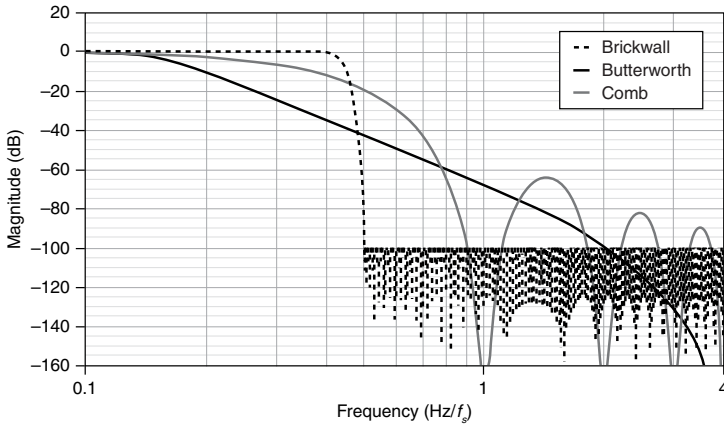

The FieldDAQ filters vary between input delay across signals in the passband:

- **Brickwall**—All input frequencies have the same amount of delay when going through the filter. Choose this filter for applications where linear phase is required or applications where data correlation between different devices and configurations is required.
- **Butterworth**—Delays signals by a variable amount depending on their frequency.
- **Comb**—All input frequencies have the same amount of delay when going through the filter. The comb filter has a shorter delay than the brickwall filter. Choose this filter for applications where linear phase, short delay, or data correlation of different devices and configurations is required.

Figure 20. Comparing Typical Input Delay for FieldDAQ Filters

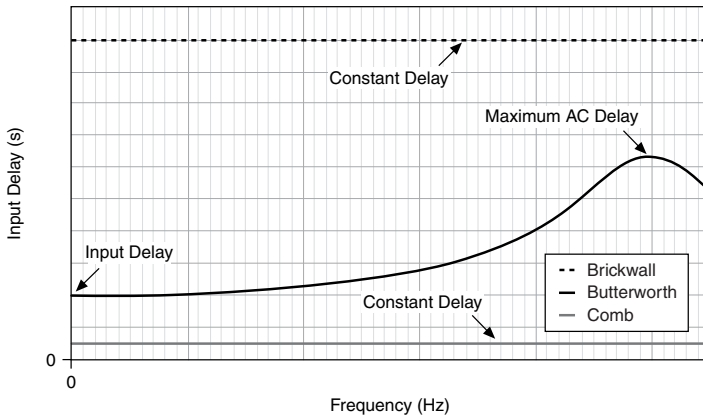

Refer to the *FD-11605 Specifications* for details on the amount of variation in the passband gain and signal delay you can expect for different input frequency ranges.

Step Response of FieldDAQ Filters

The shape of the magnitude and phase responses of a filter impacts how signals look in the time domain. The step response of a filter is typically used to identify the behavior of a filter in the time domain.

Three important factors of the filter step response are group delay, rise time, and overshoot/undershoot. The three filters differ in step response across signals in the transition band:

- **Brickwall**—Has the longest group delay. The output signal shows overshoot and undershoot.
- **Butterworth**—Has a shorter group delay and the longest rise time. The output signal shows overshoot.
- **Comb**—Has the shortest group delay and good rise time. The output signal does not show overshoot or undershoot.

Figure 21. Comparing Typical Step Response of FieldDAQ Filters

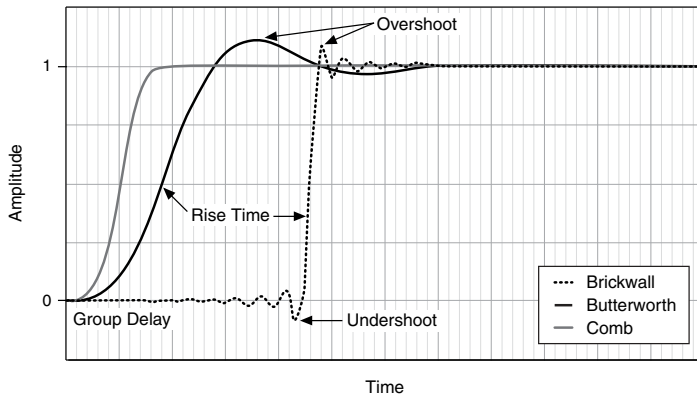

Refer to the *FD-11605 Specifications* for details on the amount of variation in the response you can expect for different input frequency ranges.

Data Rates

You can use the 13.1072 MHz, 12.8 MHz, 12.288 MHz, and 10.24 MHz timebases to generate data rates. The FD-11605 supports data rates (f_s) between 500 Samples/s and 102.4 kSamples/s. By default, NI-DAQmx automatically chooses the most suitable timebase for a selected data rate. You can also manually select a timebase through the NI-DAQmx API. Refer to [Timebases](#) in this guide and the *FD-11605 Specifications* for information about choosing the correct timebase for your data rate.

Programming the FieldDAQ Device

You can use the FieldDAQ device in the following analog input applications:

- Finite acquisition
- Continuous acquisition

The FieldDAQ device features the following timing and triggering signals:

- *AI Sample Clock Signal*
- *AI Sample Clock Timebase Signal*
- *AI Start Trigger Signal*
- *Analog Input Sync Pulse*

For more information about programming analog input applications and triggers in software, refer to the *NI-DAQmx Help* or the *LabVIEW Help* for more information.

AI Sample Clock Signal

A sample consists of one reading from each channel in the AI task. Sample Clock signals the start of a sample of all analog input channels in the task. Refer to the following figure for sample clock source options.

Figure 22. AI Sample Clock Timing Options

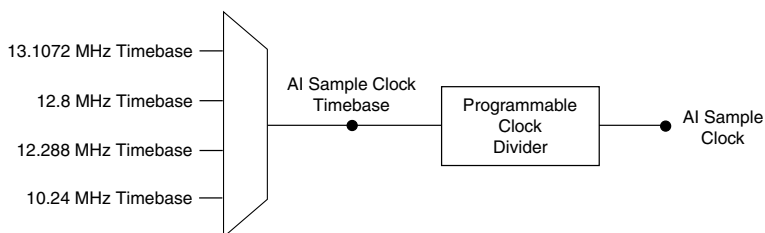

The FD-11605 is considered a Delta-Sigma device; it contains multiple A/D converters that require a high-frequency oversample clock to produce accurate, synchronized data. The FieldDAQ device returns a sample on every Sample Clock pulse.

The oversample clock is used as the AI Sample Clock Timebase. The FieldDAQ device supplies 13.1072 MHz, 12.8 MHz, 12.288 MHz, and 10.24 MHz timebases. By default, NI-DAQmx automatically chooses the most suitable timebase for a selected data rate.

The FieldDAQ device automatically issues a synchronization pulse to each bank that resets their ADCs at the same time. You can also specify a specific time for the synchronization pulse to occur. Because of the filtering used in the Delta-Sigma FieldDAQ device A/D converters, these devices exhibit a fixed input delay relative to non-Delta-Sigma devices in the system. This input delay is specified in the *FD-11605 Specifications*.

When using multiple FieldDAQ devices in a task that contains channels for a Delta-Sigma device, such as the FD-11605, ensure that one of those channels is the first in your channel list.

AI Sample Clock Timebase Signal

The AI Sample Clock Timebase signal is divided down to provide a source for Sample Clock.

AI Start Trigger Signal

Use the Start Trigger signal to begin a measurement acquisition. A measurement acquisition consists of one or more samples. If you do not use triggers, begin a measurement with a software command. Once the acquisition begins, configure the acquisition to stop in one of the following ways:

- In finite mode, when a certain number of points has been sampled
- In continuous mode, with a software command

You can specify a default delay from the Start Trigger to the first sample.

Use the Start Trigger signal with a time source, by specifying a specific time in NI-DAQmx. Refer to the *Time Triggering* topic in the *NI-DAQmx Help* for more information on accessing time-based features in the NI-DAQmx API.

Analog Input Sync Pulse

You can use time as a trigger for sync pulses on the FieldDAQ device. To use a sync pulse with a time source, specify a specific time in NI-DAQmx. Refer to the *Time Triggering* topic in the *NI-DAQmx Help* for more information on accessing time-based features in the NI-DAQmx API.



Note To accurately synchronize Delta-Sigma devices in two or more separate tasks, you must specify the same sync pulse. Otherwise, a sync pulse is initiated by software implicitly, even if time start triggers are specified for the tasks. However, for multidevice tasks, the sync pulses and start triggers are automatically synchronized.

Time-Based Triggers

FieldDAQ devices feature automatic network-based synchronization with compatible networks and 802.1AS-capable NI Linux Real-Time controllers. The SYNC logo on the device front panel indicates that the device is capable of hardware-based synchronization over a network.

FieldDAQ devices can be daisy-chained together or connected to external networks that support 802.1AS synchronization, and all device timebases will be automatically synchronized. Refer to [Synchronization across a Network](#) for more information about supported topologies and other technical requirements.

Network-synchronized devices can also take advantage of time-based synchronization features in NI-DAQmx. Certain triggers can be specified in terms of time of day. Time-based triggers and multidevice tasks (spanning multiple network-synchronized FieldDAQ devices) can help simplify programming for large systems.

Time triggers can be specified in Host Time or I/O Device Time, depending on the needs of your application.

- **I/O Device Time**—The time the FieldDAQ device uses internally. This time is determined by the network configuration and is shared by all 802.1AS network-synchronized devices on your subnet.
- **Host Time**—The time on your Windows computer or NI Linux Real-Time controller. This is usually the current global time and is provided by a local real-time clock or a network time protocol (NTP) server.

NI-DAQmx automatically translates from Host Time to I/O Device Time as necessary. The accuracy of this translation depends on the relationship between these times and can reduce the relative accuracy of time triggers across multiple devices. For maximum accuracy, use an NI Linux Real-Time controller as the host in a supported topology. However, NI-DAQmx guarantees that two tasks configured to start at the same host time always start at the same I/O Device Time in all scenarios, preserving precise synchronization between chassis in this common use case. Refer to the *Time Triggering* topic in the *NI-DAQmx Help* for more information on accessing time-based features in the NI-DAQmx API.

Timebases

The following figure shows the FD-11605 clock routing circuitry and timebases.

Figure 23. Clock Routing Circuitry

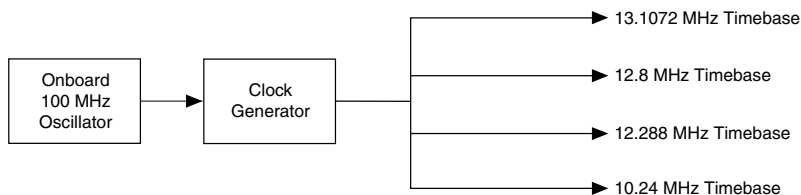

You can use the 13.1072 MHz, 12.8 MHz, 12.288 MHz, and 10.24 MHz timebases to generate the AI Sample Clock signals. These timebases are generated directly from the onboard clock generator. By default, NI-DAQmx automatically chooses the most suitable timebase for a selected data rate. You can also manually select a timebase through the NI-DAQmx API.

Refer to the *FieldDAQ Timing Considerations* and *Master Timebase Synchronization* topics in the *NI-DAQmx Help* for more information about configuring timing in the NI-DAQmx API.

Synchronization across a Network

The onboard 100 MHz oscillator automatically synchronizes to other network-synchronized devices that are part of your local 802.1AS subnet.

The 13.1072 MHz, 12.8 MHz, 12.288 MHz, and 10.24 MHz Timebases are derived from the oscillator, and are synchronized to it. Therefore, they are also synchronized to other network-

synchronized timebases on your 802.1AS subnet. This enables measurement signals to be synchronized to other devices across a distributed network.

The FieldDAQ devices use the IEEE 802.1AS protocol over the network to synchronize. They can be configured to use the IEEE 1588 "Delay Request-Response Default PTP" profile instead. These devices cannot synchronize with other 1588 profiles.

More Information about Synchronization

The following documents will help you overcome typical hurdles in getting started with synchronized measurements:

- **Synchronizing analog input FieldDAQ devices with NI-DAQmx in LabVIEW**—Visit ni.com/info and enter `fdaisync`.
- **Designing Ethernet measurement systems for synchronization, considering topologies, masters, and third party devices**—If topology changes result in a device's master changing, executing tasks may be affected. Visit ni.com/info and enter `fdenet`.
- **How to achieve high accuracy measurements**—Visit ni.com/info and enter `fdsync`.
- **Synchronization accuracy explained**—Visit ni.com/info and enter `syncacc`.
- **Synchronizing FieldDAQ and TSN-Enabled Ethernet cDAQ Chassis to a PXI System**—Visit ni.com/info and enter `fd1588`.

Ethernet Ports and Networking

The Ethernet Network Interface transfers data between the FieldDAQ device and the network. It gathers the data into TCP/IP packets that can be sent across the network and interpreted by the host.



Note Refer to [Setting up the FieldDAQ Device](#) or [Connecting to a Real-Time Controller](#) for information about connecting the FieldDAQ device to a host computer or host real-time controller.

Ethernet Ports

The FieldDAQ device has two 8-pin X-coded M12 Ethernet ports—0 and 1. You can use a shielded straight-through Ethernet or an Ethernet crossover cable with either of the Ethernet ports to network your device to a computer host, NI Linux Real-Time controller, another FieldDAQ device, or any network connection on the same subnet. Refer to [Topology Options](#) for more information about using these ports in various topologies.

Figure 24. Ethernet Connector Pinout

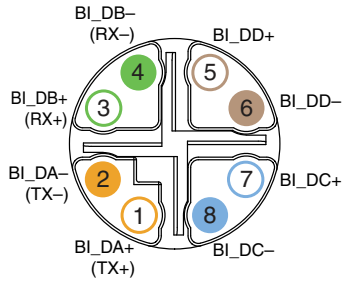

Table 8. Signal Descriptions

Pin Number	Wire Color	Gigabit Ethernet Signal	Fast Ethernet Signal
1	Orange/White	BI_DA+	TX+
2	Orange	BI_DA-	TX-
3	Green/White	BI_DB+	RX+
4	Green	BI_DB-	RX-
5	Brown/White	BI_DD+	No Connect
6	Brown	BI_DD-	No Connect
7	Blue/White	BI_DC+	No Connect
8	Blue	BI_DC-	No Connect

You can use the Ethernet ports to reset the FieldDAQ device to factory-default settings. Refer to [Resetting the FieldDAQ to Factory-Default Settings](#) for more information.

Cap the Ethernet ports when not in use.

Ethernet LEDs

Each Ethernet port has a green LED that indicates network activity and link speed.

Table 9. LED State/Device Status

LED State	Device Status
On	Ethernet link
Blinking, fast (12 blinks/s)	Ethernet activity. Connected at 1,000 Mbit/s.
Blinking, moderate (6 blinks/s)	Ethernet activity. Connected at 100 Mbit/s.

Table 9. LED State/Device Status (Continued)

LED State	Device Status
Blinking, slow (3 blinks/s)	Ethernet activity. Connected at 10 Mbit/s.
Off	No Ethernet connection

Internal Ethernet Switch

The FieldDAQ device features a full hardware-accelerated internal Ethernet switch for greater performance, wiring flexibility, and compatibility over standard Ethernet ports. The Ethernet switch exposes two Ethernet ports to the user. Either port can be used to connect the device to the network. The two ports can be used to connect multiple devices in a daisy-chain topology. The switch also supports the Rapid Spanning Tree Protocol (RSTP) algorithm, enabling ring topologies. Refer to [Topology Options](#) for more details.

IEEE 802.1AS-2011 Precision Time Protocol

The internal Ethernet switch is an 802.1AS time-aware bridge, compatible with the IEEE 802.1AS-2011 Precision Time Protocol. It can synchronize local measurement signals to other devices across an 802.1AS subnet. It can also serve as a bridge, synchronizing 802.1AS devices that are attached to each of the two ports. Refer to [Synchronization across a Network](#) for more details.

IEEE 802.1Q Rapid Spanning Tree Protocol (RSTP)

It is possible to create loops in a network using the FieldDAQ device. To prevent these loops from disrupting the network, the FieldDAQ device implements the IEEE 802.1Q Rapid Spanning Tree Protocol (RSTP). Using this protocol, each FieldDAQ device can find the shortest path for incoming packets to reach the rest of the network. When multiple paths exist, this adds a form of redundancy. If a link fails, the protocol automatically switches to use the redundant link. This process can take several seconds in some cases.

To gain these benefits on external switches connected to the FieldDAQ device, 802.1Q (RSTP) must be enabled. All external switches must be configured to allow the FieldDAQ device to transmit RSTP packets, known as Bridge Protocol Data Units (BPDU). If any switch has a feature—such as “BPDU guard”—enabled, the port connected to the FieldDAQ device is disabled and communication is lost. Refer to the documentation for your external switch for information about enabling RSTP and disabling BPDU guards on the switch.

IEEE 1588 Delay Request-Response Default Precision Time Protocol

The internal Ethernet switch can be configured to act as a 1588 "boundary clock" implementing the IEEE 1588 delay request-response default PTP profile (sometimes referred to as "default profile"). When so configured, it can synchronize local measurement signals to other devices across an IP subnetwork and can serve as a bridge, synchronizing 1588 devices

that are attached to each of the two ports. Refer to [Synchronization across a Network](#) for more details.



Note The IEEE 802.1AS protocol is an IEEE 1588 profile, but is incompatible with other IEEE 1588 profiles. When FieldDAQ devices are using the IEEE 802.1AS protocol to synchronize they cannot synchronize with devices that use other protocols or IEEE 1588 profiles and vice versa.

FieldDAQ MAC Addresses

The FieldDAQ device is associated with two MAC addresses—both of which are labeled on the device—device and switch. These MAC addresses are not associated with a particular Ethernet port, but both addresses can appear on both ports as necessary.

Table 10. NI MAX Device and Switch MAC Addresses

Device MAC Address	Switch MAC Address
Associated with the device' IP address	Associated with the internal Ethernet switch—not associated with the device's IP address
Used by normal device traffic	Used for Ethernet protocols for network configuration and synchronization
Listed in MAX	Not listed in MAX

The switch MAC address is used to implement the following switch protocols:

- IEEE 802.1AS-2011 (Precision Time Protocol)
- IEEE 802.1Q (Rapid Spanning Tree Protocol [RSTP] implemented)
- IEEE 1588 (Delay Request-Response Default Precision Time Protocol)

The switch MAC address only appears in packets exchanged between the switch embedded in the FieldDAQ device and the next Ethernet device. It will not propagate further in a properly configured network. For more information about the recommended configurations for networking the FieldDAQ device, refer to [Topology Options](#).

Topology Options

Recommended networking topologies are described in this section.

- **Host**—Can be a Windows computer or a real-time controller with the NI Linux Real-Time operating system, such as the IC-317x, cRIO-9035/9039 Sync, cRIO-904x/905x, or cDAQ-9132/9133/9134/9135/9136/9137 for LabVIEW Real-Time
- **Node**—Can be any FieldDAQ device or 802.1AS-compliant CompactDAQ chassis, such as the cDAQ-9185/9189

For more information about designing Ethernet measurement systems, visit ni.com/info and enter `fdenet`.

Line Topology

In a line topology—also known as daisy-chaining or bus topology—the host communicates directly with all nodes through one bus line. A standard Ethernet device or switch can be added to the end of the chain if desired and used as normal. Be aware that these devices will compete for network bandwidth with the FieldDAQ device. Reliable system design requires awareness of the bandwidth consumed by each device during operations. This topology offers no redundant links.

Figure 25. Line Topology

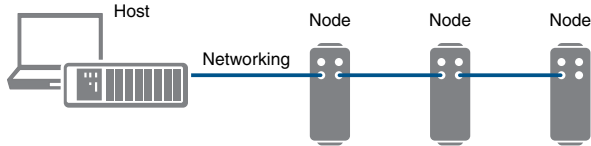

Advantages:

- Simple and inexpensive installation, expansion, and troubleshooting
- Ideal for low number of nodes. NI recommends a maximum of 15 nodes.
- No external switch needed
- Can cover long distances

Disadvantages:

- Any unpowered nodes and/or node failure disrupts network communication
- Addition or removal of any node disrupts network communication
- Failure of any Ethernet cable and/or improper cable termination disrupts network communication
- Network performance and synchronization affected when node count exceeds 15. Consider the [Star Topology](#) for systems that require a greater number of nodes.



Note For information about daisy-chaining power, refer to [Power Connectors and Wiring](#).

Ring Topology

In a ring topology, the host communicates with all nodes through the most effective path. You must use an external switch in a ring topology. You must configure the network properly with a recommended external switch before creating redundant links in the network. Refer to [External Switch Requirements](#) for information about what to look for in an external switch.

Figure 26. Ring Topology

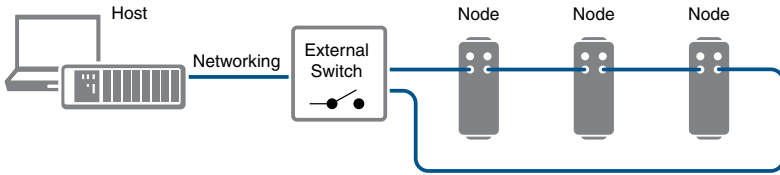

Advantages:

- Failure of any single Ethernet cable does not disrupt network communication
- Additional nodes or heavier network traffic affects network performance less than the line topology
- Simple installation
- Ideal for a local networking solution



Note Network configuration and programming require careful consideration. Visit ni.com/info and enter `fdenet` for information about exploiting link redundancy and automatically improving reliability.

Disadvantages:

- Network traffic patterns can make troubleshooting difficult
- Requires an external switch



Note For information about daisy-chaining power, refer to [Power Connectors and Wiring](#).

Star Topology

In a star topology, the host communicates directly with each node through the external switch. You must use an external switch in a star topology; for network synchronization, you must use an external 802.1AS switch. Redundant links are recommended, but optional, in this topology. You must configure the network properly with a recommended external switch before creating redundant links in the network. Refer to [External Switch Requirements](#) for information about what to look for in an external 802.1AS switch.

Figure 27. Star Topology

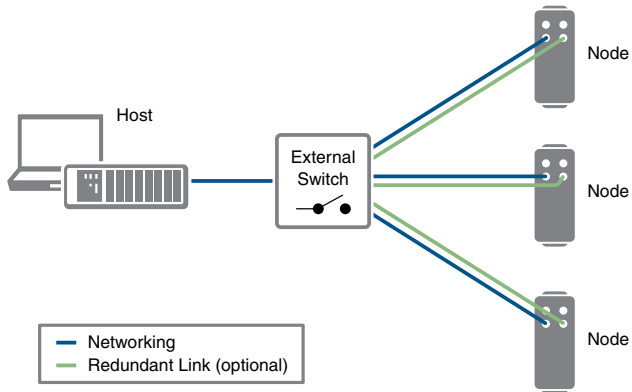

Advantages:

- Unpowered nodes and/or node failure does not disrupt network communication with other nodes
- Failure of any single Ethernet cable does not disrupt network communication when you have a redundant link
- Additional nodes or heavier network traffic affects network performance less than the other topologies
- Simple installation, expansion, and troubleshooting



Note Network configuration and programming require careful consideration. Visit ni.com/info and enter `fdenet` for information about exploiting link redundancy and automatically improving reliability.

Disadvantages:

- Most costly of the recommended topologies
- Requires an external switch (external 802.1AS switch for network synchronization)
- Covers the least distance



Note For information about daisy-chaining power, refer to *Power Connectors and Wiring*.

Other Topologies

For information about designing Ethernet measurement systems for synchronization, visit ni.com/info and enter `fdenet`.

External Switch Requirements

To meet the minimum requirements for successful operation with FieldDAQ devices, any switch directly connected to the FieldDAQ device should be compliant with IEEE 802.1Q bridges and bridged networks.

To take advantage of the network synchronization and network redundancy features of the FieldDAQ device, ensure that your network infrastructure meets certain requirements:

- **IEEE 802.1AS-2011 time-based synchronization support**—Automatically synchronizes timebases and enables the use of time-based triggers and multi-device tasks between device across the network.
- **IEEE 802.1Q (Rapid Spanning Tree Protocol) support**—Supports network redundancy functionality in ring and star topologies
 - Rapid Spanning Tree Protocol (RSTP) enabled
 - Bridge Protocol Data Units (BPDU) Guard disabled

To learn more about recommended network switches and other network configuration best practices and requirements, visit ni.com/info and enter `fdenet`.

Connecting to a Real-Time Controller

You can use the FieldDAQ device as expansion I/O from certain NI Linux Real-Time controllers. Discover and configure the NI Linux Real-Time controller in NI MAX, then discover and configure the FieldDAQ device.



Note When using an NI Real-Time controller as the host, you can only use select controllers with the NI Linux Real-Time operating system that support NI-DAQmx. Supported NI Linux Real-Time controllers include the IC-317x, cRIO-9035/9039 Sync, cRIO-904x/905x, and cDAQ-9132/9133/9134/9135/9136/9137 for LabVIEW Real-Time.¹

To network the FieldDAQ device to a Real-Time controller, you need the following items.

¹ The cDAQ-9138/9139 for LabVIEW Real-Time controllers will not work in this configuration.

Figure 28. FieldDAQ Installation Supply List

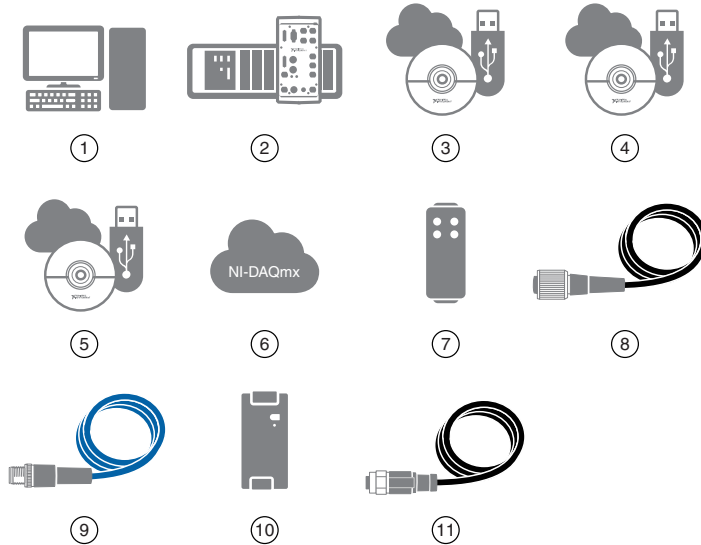

-
- | | |
|--|--|
| 1. Host Computer | 7. FieldDAQ Device |
| 2. Supported Real-Time Controller | 8. 5-pin L-coded M12 Power Input Cable |
| 3. LabVIEW Software, if not already installed | 9. 8-pin X-coded M12 Ethernet Cable |
| 4. LabVIEW Real-Time Module, if not already installed | 10. External Power Supply |
| 5. Driver for the Real-Time Controller, if not already installed | 11. 4-pin A-coded M12 I/O Cables and Accessories |
| 6. NI-DAQmx Driver, if not already installed | |
-



Note LabVIEW Real-Time 2017 or later required to use the FieldDAQ synchronization features.



Note You can either use a shielded straight-through Ethernet cable or an Ethernet crossover cable to connect the FieldDAQ device directly to your computer.

Complete the following steps.

1. Install the LabVIEW, LabVIEW Real-Time Module, and controller driver software on the host machine as instructed in the getting started or quick start document for the Real-Time controller.
2. Install NI-DAQmx on the host machine if the driver was not installed in step 1.
 - a. Download NI-DAQmx from ni.com/downloads/drivers. Complete the instructions.
 - b. Register your NI hardware online at ni.com/register when prompted.
 - c. Download NI-DAQmx to the target using MAX. Refer to the *MAX Remote Systems Help* by selecting **Help»Help Topics»Remote Systems** in MAX.
If you have problems installing your software, go to ni.com/support/daqmx.
3. Set up your Real-Time controller hardware and install software to it as instructed in the getting started or quick start document for the Real-Time controller.

4. For CompactRIO and IC controllers, perform a custom installation of the NI-DAQmx feature to the controller. In MAX, expand **Remote Systems»your Real-Time Controller**, and use the **Add/Remove Software** option. Select the custom installation option and the NI-DAQmx feature, then follow the prompts to complete the installation.
5. Make signal connections for your application.
6. Align and connect one end of the Ethernet cable to Ethernet port 0 on the FieldDAQ device, and the other end to a switch or network connection on the same subnet as your Real-Time controller, or directly to an open network port on your Real-Time controller. For more information about the recommended configurations for networking the FieldDAQ device in a Real-Time system, refer to [Topology Options](#).
7. Power the device by aligning and connecting the power IN port on FieldDAQ to an external 9 V DC to 30 V DC power source with the 5-pin L-coded M12 power cable. For information about wiring your external power source to the power connector, refer to [Wiring External Power to the FieldDAQ Device](#). The FieldDAQ device requires an external power supply that meets the specifications listed in the *FD-11605 Specifications*.

The Power LED turns on. Refer to [Power LED](#) for information about Power LED status.

8. To add the FieldDAQ to the software configuration on the Real-Time target, open NI MAX on the host computer. In the MAX configuration tree, expand **Remote Systems»your Real-Time Controller»Devices and Interfaces»Network Devices**.
9. Click **Add Network Device**, and then **Find Network NI-DAQmx Devices**.
10. In the Find Network NI-DAQmx Devices dialog box that opens, do one of the following:
 - Check the box that corresponds to your device in the Hostname column.
 - If you know the device IP address, such as 192.168.0.2, enter it into the **Add Device Manually** field of the Find Network NI-DAQmx Devices window, and click the + button.
 - Enter the hostname of the device. The default hostname is *FD11605-`<serial number>`*.

If your FieldDAQ device does not appear in Available Devices, click **Refresh List**. If the device still does not appear, contact your system administrator to confirm that the network is working and that a firewall is not interfering with discovery. For additional troubleshooting resources for the FieldDAQ device, refer to [Troubleshooting Device Connectivity](#) in this guide and the [Finding a Network DAQ Device in MAX](#) topic in the *Measurement & Automation Explorer Help for NI-DAQmx*.

11. Click **Add Selected Devices**. The FieldDAQ device is added under the Real-Time controller in the MAX configuration tree.

Figure 29. Adding the FieldDAQ Device to the Real-Time Controller in MAX

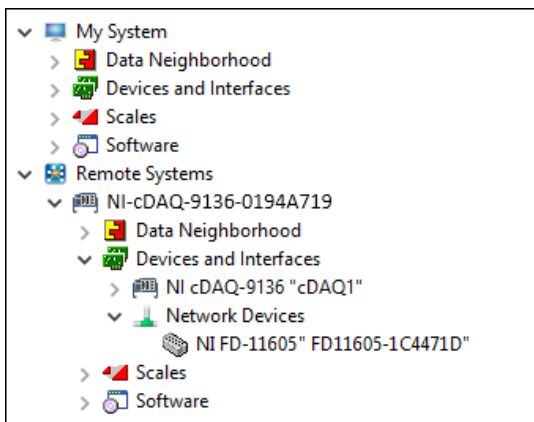

12. If the FieldDAQ device is not reserved automatically, select the device and click the **Reserve Network Device** button. Refer to [Reserving the Device in MAX](#) for more information.
13. Self-test your device in MAX by expanding **Devices and Interfaces»Network Devices**, right-clicking your FieldDAQ device, and selecting **Self-Test**. Self-test performs a brief test to determine successful device installation. When the self-test finishes, a message indicates successful verification or if an error occurred. If an error occurs, refer to [ni.com/support/daqmx](#).
14. Run a Test Panel in MAX by expanding **Devices and Interfaces»Network Devices»your FieldDAQ device**, right-clicking the bank of connectors in your FieldDAQ device, and selecting **Test Panels**. If the test panel displays an error message, refer to [ni.com/support](#). Click **Close** to exit the test panel.



Note When in use, the FieldDAQ device may become warm to the touch. This is normal.



Note M12 connectors must be mated to cables or have caps installed on them to meet IP65/IP67 requirements. Cover the unused connectors with the included plastic caps whenever water, dust, or dirt are present.



Note Avoid long periods of exposure to sunlight.

Troubleshooting Device Connectivity

If your FieldDAQ device becomes disconnected from the network, open MAX and try the following:

- After moving the device to a new network, NI-DAQmx may lose connection to the device. In this case, click **Reconnect** to provide NI-DAQmx with the new hostname or IP address.
- The FieldDAQ device icon indicates whether it is recognized and present on the network. If a connected device appears as disconnected in the configuration tree in MAX, select **Self-Test** or **Reset**. If successful, the device icon changes to dark grey.

Figure 30. MAX Icons and States



1. Discovered, but Not Added to the Network
2. Recognized, Present, and Reserved on the Network
3. Recognized, but Disconnected from the Network, Unreserved, or Reserved by Another Host

For additional troubleshooting resources for the FieldDAQ device, refer to the *Finding a Network DAQ Device in MAX* topic in the *Measurement & Automation Explorer Help for NI-DAQmx*.

Reserving the Device in MAX

When the FieldDAQ device is connected to a network, multiple users can access the device. To perform any DAQ functionality on the device, including reset and self-test, you must reserve the device in MAX. In MAX, an unreserved device or device reserved by another host appears with an X and a reserved device appears as dark grey. Only one user at a time can reserve the FieldDAQ device.

If the device was not reserved automatically after it was added (**Add Device**), you can reserve the device in MAX by expanding **Devices and Interfaces»Network Devices**, selecting the device, and clicking the **Reserve Network Device** button. The Override Reservation dialog box opens when you attempt to explicitly reserve a device. Agreeing to override the reservation forces the FieldDAQ device to be reserved by the current user.

STATUS LED

The FieldDAQ device has a STATUS LED.

Table 11. LED State/Device Status

LED Color and State	Device Status
Off	Device is reserved by NI-DAQmx but there is no activity, the device is not powered, or the device is not reserved by NI-DAQmx.
Yellow, solid	Device firmware is booting or updating.
Red, blinking	Device has reset to factory default or the firmware image is corrupted. If you are not performing a factory default reset, as listed in Resetting the FieldDAQ to Factory-Default Settings , contact NI for support on corrupted firmware.
Green, solid	Device is reserved and an NI-DAQmx task is running.

Resetting the FieldDAQ to Factory-Default Settings

To reset your FieldDAQ device to factory-default settings, complete the following steps.

1. Verify the power source is turned off.
2. Connect Ethernet port 0 and port 1 with an Ethernet cable.

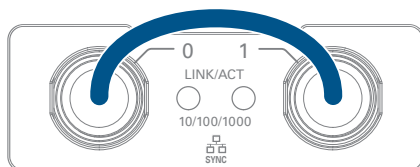
Figure 31. Connecting Port 0 and Port 1

3. Turn on the power source to the device. After about 15 seconds, the STATUS LED blinks red indicating that the device has been restored to factory-default settings.
4. Reconnect the Ethernet port 0 to the host.
5. Turn off and then turn on the power source to the device.

The FieldDAQ device factory-set defaults are listed in the following table.

Table 12. Device Default Settings

Attribute	Value
Hostname	FD11605- <i><serial number></i>
IP	DHCP or Link Local

Table 12. Device Default Settings (Continued)

Attribute	Value
Comment	Empty
Default login	User name = admin Password = no password required

Mounting

FieldDAQ can be mounted on any substrate in any orientation if the ambient temperature is 75 °C or less. However, to ensure proper functionality during use above 75 °C, you must mount the FieldDAQ device in the reference mounting configuration shown in the following figure. Observe the following guidelines to mount the FieldDAQ device in the reference mounting configuration.

Figure 32. Reference Mounting Configuration

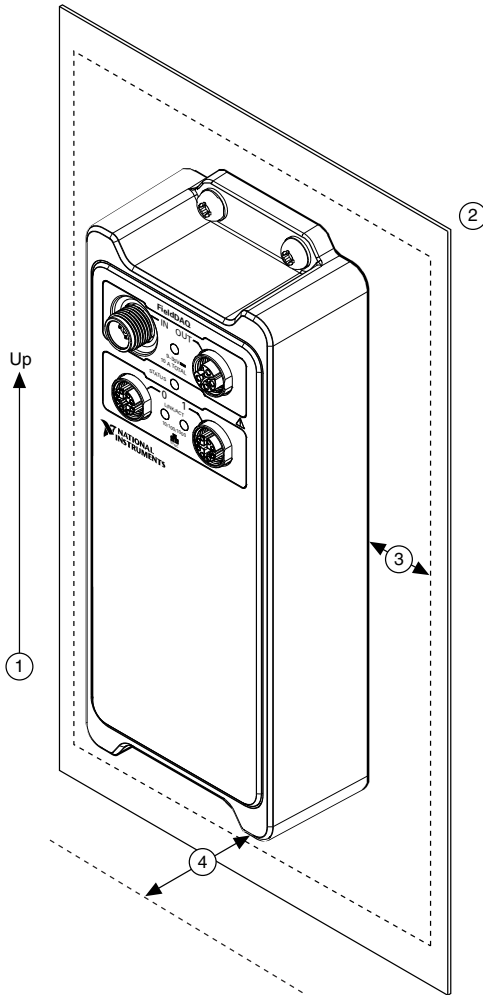

1. Vertical mounting orientation.
2. Mount the FieldDAQ device directly to a metallic surface that is at least 1.6 mm (0.062 in.) thick and extends a minimum of 76.2 mm (3 in.) beyond all edges of the device.
3. Observe the cooling dimensions in Mounting Requirements.
4. Allow space for cabling clearance according to the Mounting Requirements.

Before using any mounting methods, record the serial number from the back of the FieldDAQ device so that you can identify it in MAX. You will be unable to read the serial number after you mount the device.

Mounting Requirements

Your installation must meet the following requirements for cooling and cabling clearance. Allow 76.2 mm (3.00 in.) on all sides of the device for air circulation, as shown in the following figure.

Figure 33. Cooling Dimensions

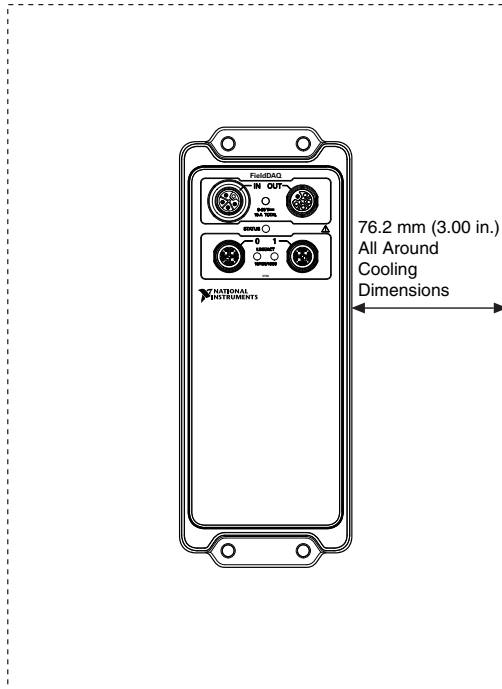

Allow the appropriate space in front of the device for cabling clearance, as shown in the following figure.

Figure 34. Cabling Clearance

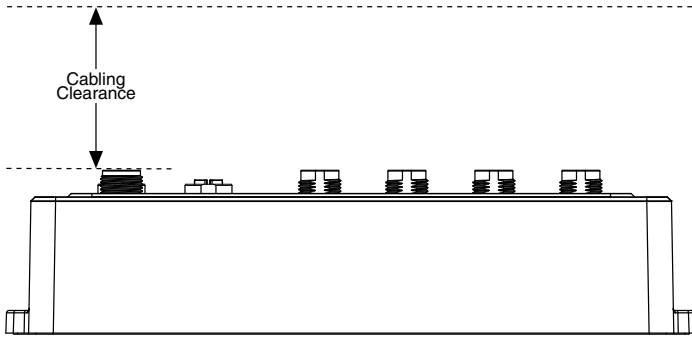

Measure the ambient temperature at each side of the FieldDAQ device, 76.2 mm (3.00 in.) from the side and 25.4 mm (1.00 in.) forward from the rear of the device. Refer to the following figures for ambient temperature locations for horizontal and vertical mounting configurations.

Figure 35. Ambient Temperature Locations, Horizontal Mounting Configuration

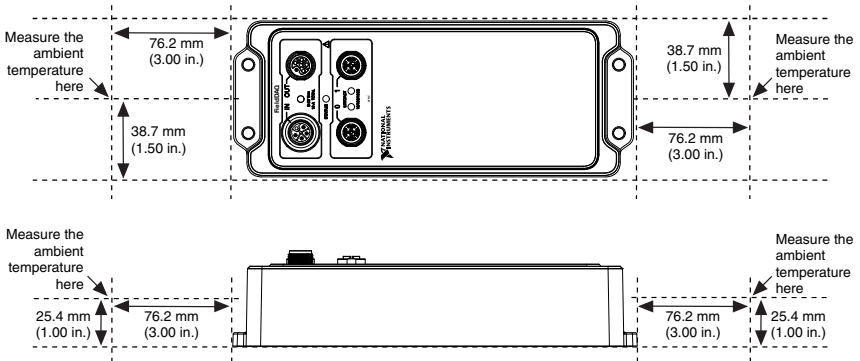
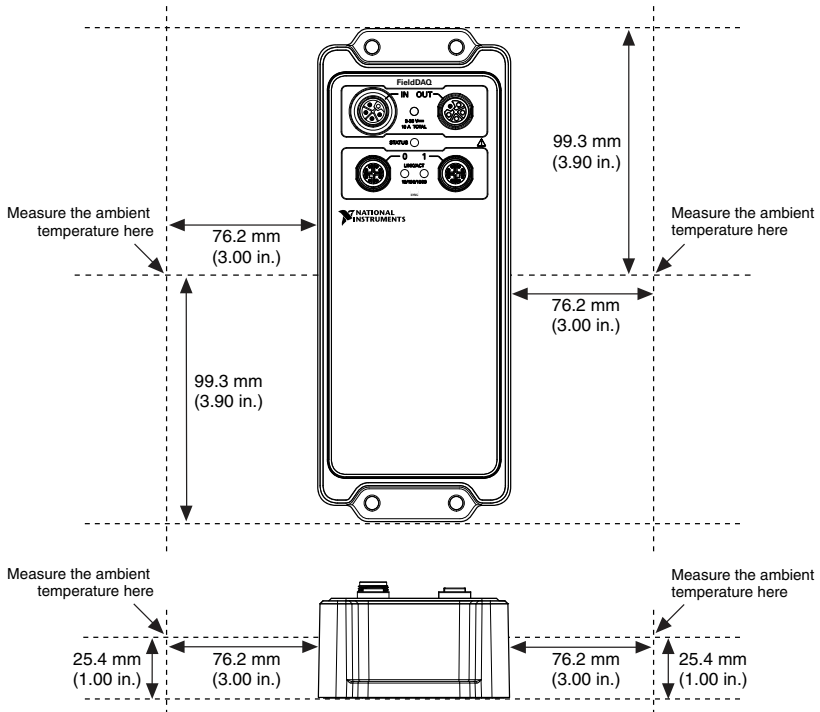

Figure 36. Ambient Temperature Locations, Vertical Mounting Configuration



Dimensions

For detailed dimensional drawings and 3D models, visit ni.com/dimensions and search for FD-11605.

Mounting the Device Directly on a Flat Surface

For environments with high shock and vibration, NI recommends mounting the FieldDAQ device directly on a flat, rigid surface using the mounting holes on the device. This mounting technique requires four M5 or 10-32 panhead or sockethead cap screws appropriate for the surface.

Complete the following steps to mount the FieldDAQ device directly on a flat surface.

1. Prepare the surface for mounting the device using the surface mounting dimensions.

Figure 37. Surface Mounting Dimensions

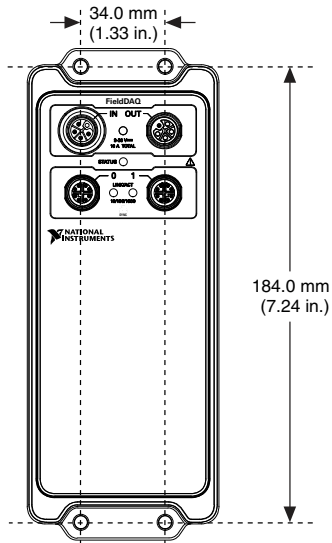

2. Align the device on the surface.
3. Fasten the device to the surface using the M5 or 10-32 screws. Tighten the screws to a maximum torque of 2.5 N · m (25.0 lb · in.).

Figure 38. Fastening the Device to the Surface

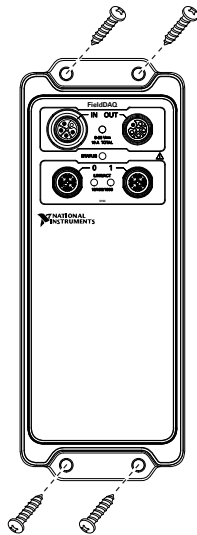

Alternate Mounting Configurations

The maximum operating temperature of 85 °C may be reduced for any mounting configuration other than the reference mounting configuration. A 10 °C (18 °F) reduction in maximum operating temperature is sufficient for most alternate mounting configurations. Follow the mounting requirements for all mounting configurations.

The published accuracy specifications, although not guaranteed for alternate mounting configurations, may be met depending on the system power and the thermal performance of the alternate mounting configuration.

Contact NI for further details regarding the impact of common alternate mounting configurations on maximum operating temperature and accuracy.

Mounting the Device on a DIN Rail

The FD-11960 DIN rail mounting kit is an accessory you can use to mount a FieldDAQ device to a DIN rail. The hardware in the FD-11960 DIN rail mounting kit includes a bracket panel, a DIN rail clip, four M5 x 10 mm screws, four M5 washers, and two 8-32 x 1/4 in. screws.

Complete the following steps to install a FieldDAQ device onto a DIN rail using the FD-11960 DIN rail mounting kit.

1. Attach the FieldDAQ device to the bracket panel using the included M5 x 10 mm screws and M5 washers. The front of the bracket panel, which includes an outline of the FieldDAQ device, should be attached to the back of the FieldDAQ device.
2. Attach the DIN rail clip to the FieldDAQ device and bracket panel using the 8-32 x 1/4 in. screws included in the kit. Tighten the screws to a maximum torque of 1.3 N · m (11.5 lb · in.).

Figure 39. Attaching a FieldDAQ Device to the Bracket and DIN Rail Clip

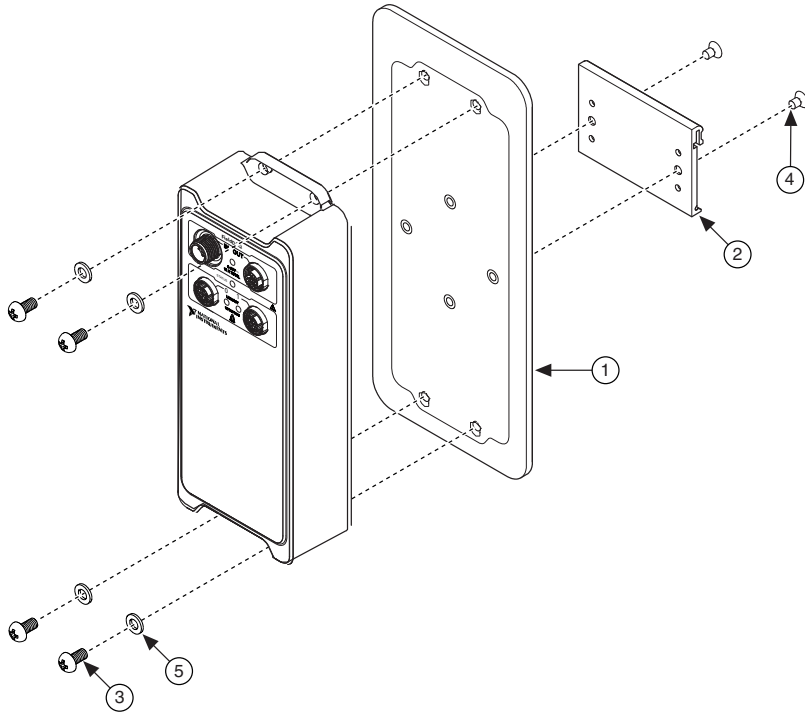

-
- | | |
|---------------------|-------------------------|
| 1. Bracket panel | 4. 8-32 x 1/4 in. screw |
| 2. DIN rail clip | 5. M5 washers |
| 3. M5 x 10 mm screw | |
-



Note You can also horizontally mount the FieldDAQ device to the DIN rail.

3. Clip the device onto the DIN rail.

Figure 40. DIN Rail Clip Parts Locator

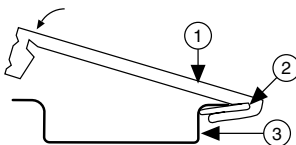

-
- | |
|--------------------|
| 1. DIN rail clip |
| 2. DIN rail spring |
| 3. DIN rail |
-

Figure 41. FD-11960 Dimensions

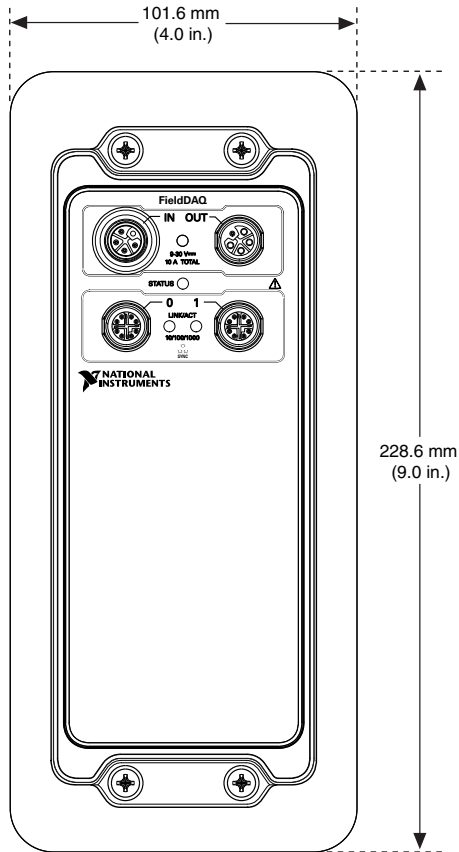

Firmware

Firmware can be updated through NI MAX or the web interface to the device. For FieldDAQ firmware information and updates, visit ni.com/info and enter the Info Code `fdfw`.

Maintenance

If you need to clean your device, wipe it with a dry towel.



Note M12 connectors must be mated to cables or have caps installed on them to meet IP65/IP67 requirements. Cover the unused connectors with the included plastic caps whenever water, dust, or dirt are present.



Note Avoid long periods of exposure to sunlight.

Where to Go from Here

This section lists where you can find example programs for the FieldDAQ device and relevant documentation.

Example Programs

NI-DAQmx software includes example programs to help you get started programming with the FieldDAQ device. Modify example code and save it in an application, or use examples to develop a new application, or add example code to an existing application.

To locate NI software examples, go to ni.com/info and enter the Info Code `daqmxexp`.

To run examples without the device installed, use an NI-DAQmx simulated device. For more information, in Measurement & Automation Explorer (MAX), select **Help»Help Topics»NI-DAQmx»MAX Help for NI-DAQmx** and search for simulated devices.

Related Documentation

Each application software package and driver includes information about writing applications for taking measurements and controlling measurement devices. The following references to documents assume you have NI-DAQmx 19.0 or later.

FieldDAQ

The *FD-11605 Quick Start*, packaged with your device, describes how to install your NI-DAQmx for Windows software, how to set up your FieldDAQ device, and confirm that your device is operating properly.

The *FD-11605 Specifications* lists all specifications for your FieldDAQ device. Go to ni.com/manuals and search for FD-11605.

The *FD-11605 Safety, Environmental, and Regulatory Information*, packaged with your device, includes important compliance precautions and connection information for your FieldDAQ device.

NI-DAQmx

The *NI-DAQmx Readme* lists which devices, ADEs, and NI application software are supported by this version of NI-DAQmx. Select **Start»All Programs»National Instruments»NI-DAQmx»NI-DAQmx Readme**.

The *NI-DAQmx Help* contains API overviews, general information about measurement concepts, key NI-DAQmx concepts, and common applications that are applicable to all programming environments. Select **Start»All Programs»National Instruments»NI-DAQmx»NI-DAQmx Help**.

LabVIEW NXG

Refer to the *Taking NI-DAQmx Measurements* lessons to assist in getting started in LabVIEW NXG, beginning with *NI-DAQmx API Basics*. To access these lessons, enter `taking NI-DAQmx measurements` in the Search bar in LabVIEW NXG.

LabVIEW

Use the *LabVIEW Help*, available by selecting **Help»LabVIEW Help** in LabVIEW, to access information about LabVIEW programming concepts, step-by-step instructions for using LabVIEW, and reference information about LabVIEW VIs, functions, palettes, menus, and tools. Refer to the following locations on the **Contents** tab of the *LabVIEW Help* for information about NI-DAQmx:

- **VI and Function Reference»Measurement I/O VIs and Functions»DAQmx - Data Acquisition VIs and Functions**—Describes the LabVIEW NI-DAQmx VIs and functions.
- **Property and Method Reference»NI-DAQmx Properties**—Contains the property reference.
- **Taking Measurements**—Contains the conceptual and how-to information you need to acquire and analyze measurement data in LabVIEW, including common measurements, measurement fundamentals, NI-DAQmx key concepts, and device considerations.

LabVIEW Real-Time

The *Real-Time Module Concepts* book of the *LabVIEW Real-Time Module Help* includes conceptual information about real-time programming techniques, application architectures, and Real-Time Module features you can use to create real-time applications. Refer to the *Real-Time Module Concepts* before attempting to create a deterministic real-time application.

LabWindows/CVI

The **Data Acquisition** book of the *LabWindows/CVI Help* contains *Taking an NI-DAQmx Measurement in LabWindows/CVI*, which includes step-by-step instructions about creating a measurement task using the DAQ Assistant. In LabWindows™/CVI™, select **Help»Contents**, then select **Using LabWindows/CVI»Data Acquisition**. This book also contains information about accessing detailed information through the *NI-DAQmx Help*.

The **NI-DAQmx Library** book of the *LabWindows/CVI Help* contains API overviews and function reference for NI-DAQmx. Select **Library Reference»NI-DAQmx Library** in the *LabWindows/CVI Help*.

Microsoft Visual Studio Support

You can use the NI-DAQmx .NET class library to communicate with and control an NI data acquisition (DAQ) device. Documentation for the NI-DAQmx .NET class library is available by selecting **Start»All Programs»National Instruments»NI-DAQmx»NI-DAQmx**

Documentation and then opening the `NINETDAQmxFxxx.chm` help file corresponding to the version of NI-DAQmx .NET Framework language support you have installed.

- **Measurement Studio Support for NI-DAQmx**—If you program your NI-DAQmx-supported device in Visual Studio using Visual C# or Visual Basic .NET, you can interactively create channels and tasks using Measurement Studio and the DAQ Assistant. Additionally, you can use Measurement Studio to generate the configuration code based on your task or channel. Refer to the *DAQ Assistant Help* for additional information about generating code.

To create an NI-DAQmx application using Visual Basic .NET or Visual C#, follow these general steps:

1. In Visual Studio, select **File»New»Project** to launch the New Project dialog box.
 2. Choose a programming language (Visual C# or Visual Basic .NET), and then select **Measurement Studio** to see a list of project templates.
 3. Select **NI DAQ Windows Application**. Choose a project type. You add DAQ tasks as a part of this step.
- **.NET Languages without NI Application Software**—With the Microsoft .NET Framework, you can use the NI-DAQmx .NET class library to create applications using Visual C# and Visual Basic .NET without Measurement Studio. Refer to the *NI-DAQmx Readme* for specific versions supported.

ANSI C without NI Application Software

The *NI-DAQmx Help* contains API overviews and general information about measurement concepts. Select **Start»All Programs»National Instruments»NI-DAQmx»NI-DAQmx Help**.

The *NI-DAQmx C Reference Help* describes the NI-DAQmx Library functions, which you can use with National Instruments data acquisition devices to develop instrumentation, acquisition, and control applications. Select **Start»All Programs»National Instruments»NI-DAQmx»Text-Based Code Support»NI-DAQmx C Reference Help**.

Training Courses

If you need more help getting started developing an application with NI products, NI offers training courses. To enroll in a course or obtain a detailed course outline, refer to ni.com/training.

Technical Support on the Web

For additional support, refer to ni.com/support or ni.com/examples.

Many DAQ specifications and user guides and manuals are available as PDFs. You must have Adobe Reader 7.0 or later (PDF 1.6 or later) installed to view the PDFs. Refer to the Adobe Systems Incorporated website at www.adobe.com to download Adobe Reader. Refer to the National Instruments Product Manuals Library at ni.com/manuals for updated documentation resources.

Information is subject to change without notice. Refer to the *NI Trademarks and Logo Guidelines* at ni.com/trademarks for information on NI trademarks. Other product and company names mentioned herein are trademarks or trade names of their respective companies. For patents covering NI products/technology, refer to the appropriate location: **Help»Patents** in your software, the `patents.txt` file on your media, or the *National Instruments Patent Notice* at ni.com/patents. You can find information about end-user license agreements (EULAs) and third-party legal notices in the `readme` file for your NI product. Refer to the *Export Compliance Information* at ni.com/legal/export-compliance for the NI global trade compliance policy and how to obtain relevant HTS codes, ECCNs, and other import/export data. NI MAKES NO EXPRESS OR IMPLIED WARRANTIES AS TO THE ACCURACY OF THE INFORMATION CONTAINED HEREIN AND SHALL NOT BE LIABLE FOR ANY ERRORS. U.S. Government Customers: The data contained in this manual was developed at private expense and is subject to the applicable limited rights and restricted data rights as set forth in FAR 52.227-14, DFAR 252.227-7014, and DFAR 252.227-7015.

© 2019 National Instruments. All rights reserved.

377829A-01 May 20, 2019