

**3274**

**3275**

**CLAMP ON PROBE**

**HIOKI**

Instruction Manual

**EN**

May 2015 Revised edition 5  
3275A981-05 15-05H





# Contents

|   |    |
|---|----|
| Introduction .....                          | 1  |
| Inspection .....                            | 1  |
| Notes on Safety .....                       | 1  |
| Notes on Use .....                          | 4  |
| <br>  |    |
| Chapter 1 Overview .....                    | 9  |
| 1.1 Product Overview .....                  | 9  |
| 1.2 Features .....                          | 9  |
| 1.3 Names of Parts .....                    | 10 |
| 1.4 Parts of the Sensor .....               | 11 |
| <br>  |    |
| Chapter 2 Specifications .....              | 13 |
| 2.1 Product Specifications .....            | 13 |
| 2.2 Standards Applying .....                | 15 |
| <br>  |    |
| Chapter 3 Measurement Procedure .....       | 19 |
| 3.1 Notes on Use .....                      | 19 |
| 3.2 Preparations for Measurement .....      | 20 |
| 3.3 Demagnetizing and Zero Adjustment ..... | 21 |
| 3.4 Measurement Procedure .....             | 22 |



---

## Introduction

Thank you for purchasing this HIOKI 3274, 3275 CLAMP ON PROBE.

To obtain maximum performance from the device, please read this manual first, and keep it handy for future reference.

---

## Inspection

When you receive the device, inspect it carefully to ensure that no damage occurred during shipping. If damage is evident, or if it fails to operate according to the specifications, contact your dealer or Hioki representative.

Supplied accessories

|                    |   |
|--------------------|---|
| Instruction manual | 1 |
| Carrying case      | 1 |

---

## Notes on Safety







**WARNING**

**This device is designed to comply with IEC 61010 Safety Standards, and has been thoroughly tested for safety prior to shipment. However, mishandling during use could result in injury or death, as well as damage to the device. Be certain that you understand the instructions and precautions in the manual before use. We disclaim any responsibility for accidents or injuries not resulting directly from device defects.**





---

## Safety Symbols

This manual contains information and warnings essential for safe operation of the device and for maintaining it in safe operating condition. Before using the device, be sure to carefully read the following safety notes.

|   |  |
|---|--|
|  | <ul style="list-style-type: none"> <li>• The  symbol printed on the device indicates that the user should refer to a corresponding topic in the manual (marked with the  symbol) before using the relevant function.</li> <li>• In the manual, the  symbol indicates particularly important information that the user should read before using the device.</li> </ul> |
|  | <ul style="list-style-type: none"> <li>• Indicates that only insulated conductors suited to the voltage of the circuit under test can be measured.</li> </ul>  |

The following symbols in this manual indicate the relative importance of cautions and warnings.

|   |   |
|---|---|
|    | <p>Indicates that incorrect operation presents an extreme hazard that could result in serious injury or death to the user.</p>    |
|  | <p>Indicates that incorrect operation presents a significant hazard that could result in serious injury or death to the user.</p> |
|  | <p>Indicates that incorrect operation presents a possibility of injury to the user or damage to the device.</p>                   |
|  | <p>Indicates advisory items related to performance or correct operation of the device.</p>  |



---

## Notes on Use

Follow these precautions to ensure safe operation and to obtain the full benefits of the various functions.

**⚠ DANGER**

- Do not measure around a bare conductor. Doing so may result in short-circuit or electric shock. Take measurements at a location on an insulated wire where there is sufficient insulation for the circuit voltage.
- Refer to the derating characteristics when measuring current that includes a highfrequency component and never measure any current that exceeds the rated current.
- Use with high frequencies or strong magnetic fields may cause the device to become abnormally hot, resulting in fire, equipment damage, or burns. (See “ 2 Specifications ” (p. 12).)

Observe the following to avoid electric shock and short circuits.

- Connect the device to the 3269 or the 3272 Power Supply and waveform measurement instrument (oscilloscope or recorder) first, and then to the active lines to be measured.
  - When the sensor is opened, do not shortcircuit the conductor being measured or other two wires with the metal part of the tip.
  - Be careful to avoid damaging the insulation surface while taking measurements.
-



- Before clamping the conductor being measured, make sure that the insulation on the conductor is undamaged. Also, take care not to damage the insulation when clamping the conductor. Any damage to the insulation could cause an electric shock.
- This instrument is made for use with the 3269 or 3272 POWER SUPPLY.
- To prevent fire or damage of the measurement target and device as well as burns, exercise caution concerning the following when measuring high-frequency currents or currents that contain high-frequency components:
  - Eddy current loss may cause heating of the sensor head.
  - Dielectric heating may cause heating of cord insulation and other materials.
- This device should only be connected to the secondary side of a breaker, so the breaker can prevent an accident if a short circuit occurs. Connections should never be made to the primary side of a breaker, because unrestricted current flow could cause a serious accident if a short circuit occurs.
- Be sure to observe all operating precautions for the waveform monitoring instrument (oscilloscope or recorder) and other measurement instruments to which this device is connected.



**DANGER**

- When using a measurement instrument that does not provide isolation between its input terminals and chassis or other input terminals, please pay attention to the following points.

If a signal is applied to an input terminal other than that to which this device is connected, do not connect the ground-side terminal to any non-ground potential. Otherwise, short-circuit current will flow through the 3269 or 3272, or this device from the ground terminal, which could cause an electrical accident or damage.

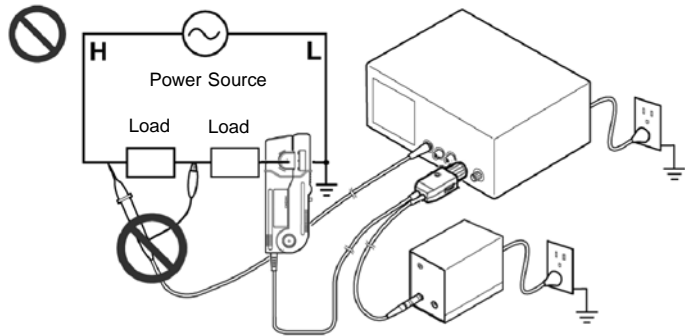

**⚠ WARNING**

- **Do not allow the device to get wet, and do not take measurements with wet hands. This may cause an electric shock.**
- **Do not press the demagnetizing switch (DEMAG) to perform demagnetization while the conductor being measured is clamped. Doing so could damage the circuitry or cause an accident that might result in injury or death.**
- **Ensure that the input does not exceed the maximum rated current to avoid device damage, shortcircuiting and electric shock resulting from heat building.**

**⚠ CAUTION**

- To avoid damage to the device, protect it from vibration or shock during transport and handling, and be especially careful to avoid dropping.
- Do not store or use the device where it could be exposed to direct sunlight, high temperature, humidity, or condensation. Under such conditions, the device may be damaged and insulation may deteriorate so that it no longer meets specifications.
- Before using the device the first time, verify that it operates normally to ensure that no damage occurred during storage or shipping. If you find any damage, contact your dealer or Hioki representative.
- This device is not designed to be entirely water- or dust- proof. To avoid damage, do not use it in a wet or dusty environment.
- The sensor head is a precision assembly including a molded component, a ferrite core, and a Hall effect element. It may be damaged if subjected to sudden changes in ambient temperature, or mechanical strain or shock, and therefore great care should be exercised in handling it.

**CAUTION**

- The matching surfaces of the sensor head are precision ground, and should be treated with care. If these surfaces are scratched, performance may be impaired.
- Do not apply a static electricity or other source of high voltage to the sensor. Doing so may damage its internal Hall elements and circuitry.
- Foreign substances such as dust on the contact surfaces of the sensor head can cause acoustic resonance and degrade measurement, so it should be cleaned by gently wiping with a soft cloth. Refer to NOTE (p26) for resonance sound.
- To avoid damaging the sensor cable and power supply cable, do not bend or pull the cables.
- When the power is on, keep closed, except when clamping them onto the conductor to be measured. The facing surface of the core section can be scratched while it is open.
- Do not short-circuit the output terminal and do not input voltage to the output terminal. The device may be damaged.
- Note that the device may be damaged if the applied current exceeds the measurement range.
- When the 3269, 3272 Power Supply or waveform measurement instrument 's power is turned off, do not apply current to the device. Doing so may damage the device, the 3269, 3272 Power Supply and/or waveform measurement instrument.

**NOTE**

- Correct measurement may be impossible in the presence of strong magnetic fields, such as near transformers and high-current conductors, or in the presence of strong electromagnetic fields such as near radio transmitters.

## Service / Maintenance

- To clean the device, wipe it gently with a soft cloth moistened with water or mild detergent. Never use solvents such as benzene, alcohol, acetone, ether, ketones, thinners or gasoline, as they can deform and discolor the case.
  - If the device seems to be malfunctioning, contact your dealer or Hioki representative.
  - When sending the device for repair, pack carefully to prevent damage in transit. Include cushioning material so the device cannot move within the package. Be sure to include details of the problem.
  - Hioki cannot be responsible for damage that occurs during shipment.
  - Use the original packing materials when transporting the device, if possible.
  - Transport the device in its carrying case.
-

---

# Chapter 1

## Overview

---

---

### 1.1 Product Overview

This device can be directly connected to a BNC input connector of a waveform measuring instrument such as an oscilloscope or recorder, and by clamping on a conductor to be measured, allows the current waveform to be easily captured.

---

### 1.2 Features

- Highly accurate current detection.
- Easy current measurement.
- Broadband frequency characteristics.  
Model 3274 : DC to 10 MHz  
Model 3275 : DC to 2 MHz
- Large diameter allows high-current measurements.
- Easy protection function to avoid self-heating during excessive input.
- Unique HIOKI development of thin film Hall effect element

## 1.3 Names of Parts

External view

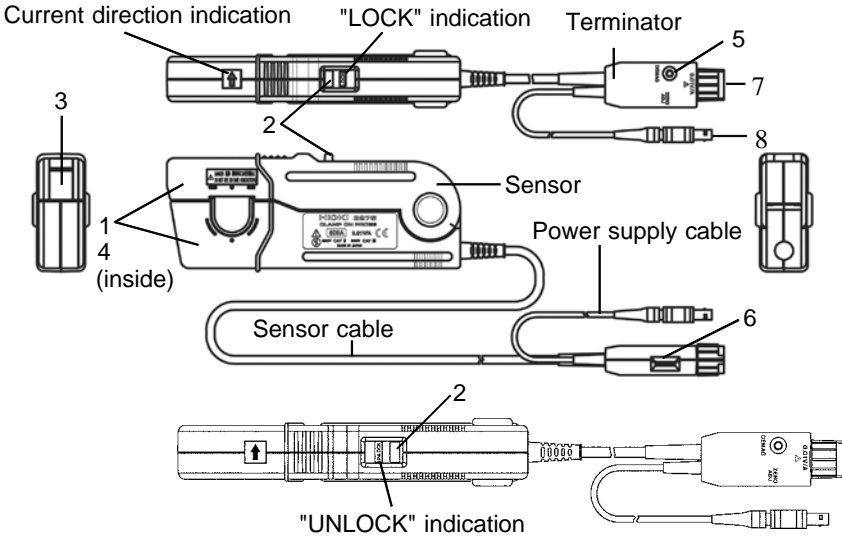

---

## 1.4 Parts of the Sensor

### 1. Clamp

This clamps around the conductor to be measured.

### 2. Slider

This slider opens the clamp. Always use it to open and close the clamp.

### 3. Lever

This lock mechanism keeps the clamp closed.

### 4. Sensor head

This clamps the conductor being measured, and carries out the actual current measurement. It is a precision assembly including a molded component, a ferrite core, and a Hall effect element. It may be damaged if subjected to sudden changes in ambient temperature, or mechanical strain or shock, and therefore great care should be exercised in handling it.

### 5. Demagnetizing switch (DEMAG)

This demagnetizes the core if it has been magnetized by switching the power on and off, or by an excessive input. Always carry out demagnetizing before measurement.

The demagnetizing process takes about 3 second. During demagnetizing, a demagnetizing waveform is output.

### 6. Zero adjustment dial (ZERO ADJ)

Use the zero adjustment dial to correct for the effect of a voltage offset or temperature drift on the device.

When beginning measurement, after demagnetizing always carry out zero adjustment.

## 7. Output connector

The current waveform of the measured conductor is output at a constant rate (0.01 V/A).

Connect to the BNC input connector of the waveform measuring instrument.

### NOTE

- The output of this device is terminated internally. Since the output resistance is approx. 7  $\Omega$  (model 3274) and approx. 40  $\Omega$  (model 3275), the device must be used with a high-impedance input to the measuring instrument. With an input impedance of 50  $\Omega$ , accurate measurement is not possible.
- If using BNC-banana plug adapters or similar to connect to input terminals other than BNC connectors, make sure the polarity is correct.
- Turn the collar until it clicks, and check that it is locked securely.

## 8. Power plug

Connect this to the 3269 or 3272 POWER SUPPLY receptacle to supply power to the sensor terminator.



---

# Chapter 2 Specifications

---



---

## 2.1 Product Specifications

Guaranteed at  $23^{\circ}\text{C} \pm 3^{\circ}\text{C}$  ( $73^{\circ}\text{F} \pm 5.4^{\circ}\text{F}$ ) after the power has been on for 30 minutes.

|                                |  |
|--------------------------------|--|
| Bandwidth                      | Model 3274 : DC to 10 MHz (-3 dB)<br>(Typical characteristics shown in Fig.1)<br>Model 3275 : DC to 2 MHz (-3 dB)<br>(Typical characteristics shown in Fig.2)  |
| Rise time                      | Model 3274 : 35 ns or less<br>Model 3275 : 175 ns or less  |
| Maximum continuous input range | Model 3274 : 150 A<br>(Derating according to frequency shown in Fig.3)<br>Model 3275 : 500 A<br>(Derating according to frequency shown in Fig.4)   |
| Maximum peak current value     | Model 3274 : Non-continuous 300 A peak<br>500 A peak at pulse width 30 $\mu$ s<br>Model 3275 : Non-continuous 700 A peak   |
| Output voltage rate            | 0.01 V/A   |
| Amplitude accuracy             | Model 3274 : To 150 A: $\pm 1.0\%$ rdg. $\pm 1$ mV<br>150 A to 300 A peak: $\pm 2.0\%$ rdg.<br>(DC, and 45 to 66 Hz)<br>Model 3275 : To 500 A: $\pm 1.0\%$ rdg. $\pm 5$ mV<br>To 700 A peak: $\pm 2.0\%$ rdg.<br>(DC, and 45 to 66 Hz) |
| Noise                          | Equivalent to 25 mA rms or less (for 20 MHz band measuring instrument)   |
| Input impedance                | Model 3274 (Typical characteristics shown in Fig.5)<br>Model 3275 (Typical characteristics shown in Fig.6)   |

|  |   |
|--|---|
| Temperature coefficient for sensitivity  | $\pm 2\%$ or less<br>Model 3274 (Input: 55 Hz 150 A, within a range of 0 to 40°C, within a range of 32 to 104°F)<br>Model 3275 (Input: 50 Hz 500 A, within a range of 0 to 40°C, within a range of 32 to 104°F) |
| Maximum rated power                      | Model 3274 : 5.5 VA<br>Model 3275 : 7.2 VA<br>(within maximum continuous input range)   |
| Rated supply voltage                     | Model 3274 : $\pm 12$ V $\pm 1$ V<br>Model 3275 : $\pm 12$ V $\pm 0.5$ V  |
| Operating temperature and humidity range | 0 to 40°C (32 to 104°F), 80 % RH or less (no condensation)  |
| Storage temperature and humidity range   | -10 to 50 °C (14 to 122°F), 80 % RH or less (no condensation)   |
| Location for use                         | Indoor, altitude up to 2000 m (6562 feet), Pollution Degree 2   |
| Period of guaranteed accuracy            | 1 year (Opening/Closing up to 10,000 times)   |
| Effect of external magnetic fields       | Model 3274 : Equivalent to a maximum of 150 mA<br>Model 3275 : Equivalent to a maximum of 800 mA<br>(in a DC or 60 Hz, 400 A/m magnetic field)  |
| Diameter of measurable conductors        | 20 mm dia.<br>0.79" dia.  |
| Measurable conductors                    | Insulated conductor   |
| Cable lengths                            | Sensor cable Approx. 2 m (78.7")<br>Power supply cable Approx. 1 m (39.4")  |
| External dimensions                      | Sensor Approx. 176W X 69H X 27D mm<br>Approx. 6.93"W X 2.72"H X 1.06"D<br>Terminator Approx. 27H X 55W X 18D mm<br>Approx. 1.06"W X 2.17"H X 0.71"D   |
| Mass                                     | Model 3274 : Approx. 500 g (Approx. 17.6 oz.)<br>Model 3275 : Approx. 520 g (Approx. 18.3 oz.)  |
| Accessories                              | Instruction manual, Carrying case   |

---

## 2.2 Standards Applying

---

|        |         |
|--------|---------|
| Safety | EN61010 |
|--------|---------|

---

|     |         |
|-----|---------|
| EMC | EN61326 |
|-----|---------|

---

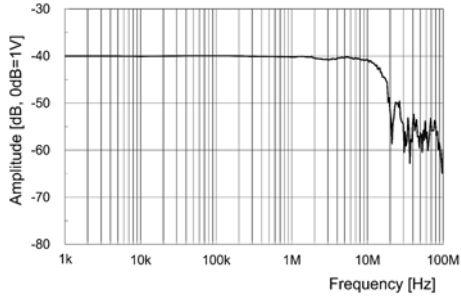

Fig.1 Frequency characteristics (Typical) (3274)

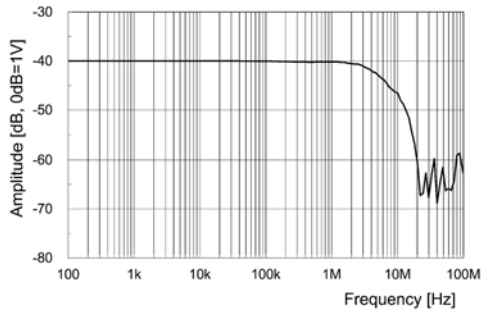

Fig.2 Frequency characteristics (Typical) (3275)

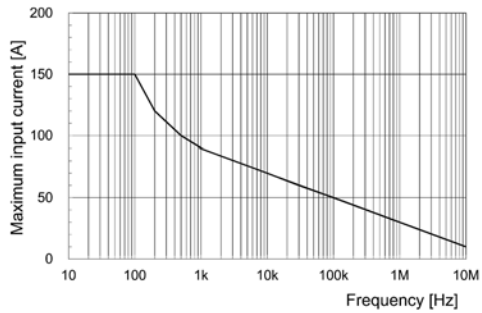

Fig.3 Derating according to frequency(3274)

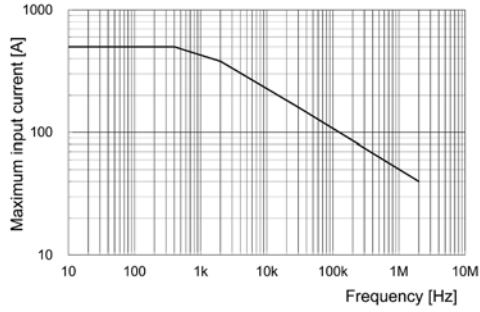

Fig.4 Derating according to frequency(3275)

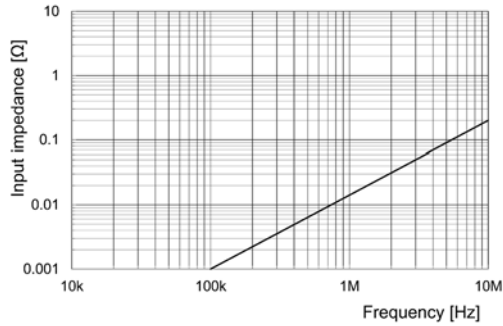

Fig.5 Input impedance (Typical) (3274)

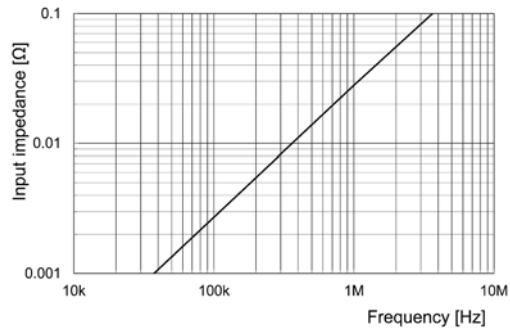

Fig.6 Input impedance (Typical) (3275)





---

# Chapter 3

## Measurement Procedure

---

---

### 3.1 Notes on Use

Before using the instrument, make sure to refer to “Notes on Use” (p.3 to p.8).

---

## 3.2 Preparations for Measurement

- (1) Have the 3269 or 3272 POWER SUPPLY, and oscilloscope or recorder for waveform measurement ready.

**CAUTION**

Before turning the device on, make sure the source voltage matches that indicated on the rear panel of the 3269 or 3272. Connection to an improper supply voltage may damage the 3269 or 3272 and present an electrical hazard.

- (2) Turn the power switch off and connect the power cord.
- (3) Connect the power plug of the 3274 or 3275 to the power receptacle of the 3269 or 3272.

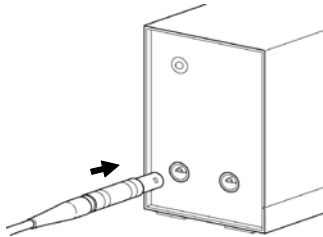

- (4) Turn the 3269 or 3272 power switch on, and check that the front panel power indicator lights.
- (5) Wait at least 30 minutes after turning on the device.  
Immediately after power is supplied, offset drift may increase due to the effects of self-heating of the device and other factors.  
To ensure accurate measurement, wait at least 30 minutes after turning on the device before performing measurement.



### 3.3 Demagnetizing and Zero Adjustment

- (1) With the waveform measurement instrument input at ground, adjust the trace to the zero position.
- (2) Set the input coupling of the waveform measurement instrument to DC.
- (3) Connect the output connector of the 3274 or 3275 to the input connector of the waveform measurement instrument. Turn the collar until it clicks, and check that it is locked securely.

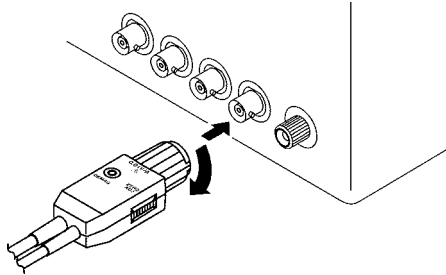

#### CAUTION

- When disconnecting the output connector, be sure to release the lock before pulling off the connector. Forcibly pulling the connector without releasing the lock, or pulling on the cable, can damage the terminator.
- If using BNC-banana plug adapters or similar to connect to input terminals other than BNC connectors, make sure the polarity is correct.
- Do not demagnetize while the 3274 or 3275 is clamping a conductor to be measured. Demagnetizing causes current to flow into the conductor, which may damage parts in the circuit to be measured.

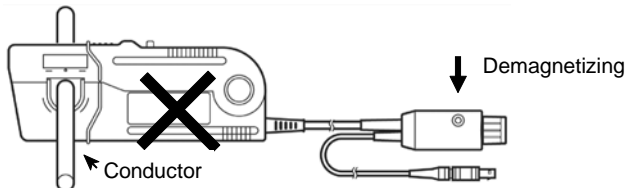

- Check that the conductor being measured is not clamped when supplying power to the 3274 or 3275 for the same reason. Demagnetized waveforms are generated when supplying electric power.

- (4) Before clamping a conductor, confirm that the clamp can be securely closed: press the slider until UNLOCK is no longer displayed, and hold it until LOCK appears.
- (5) Press the demagnetizing switch (DEMAG) on the terminator.
- (6) Turn the zero adjustment dial on the terminator, to adjust the trace to the zero position.

---

## 3.4 Measurement Procedure

- (1) Check that the system is safe, and that the preparations described in the preceding section have been carried out.
- (2) Pull the sensor slider, so that the clamp opens.
- (3) Align the sensor so that the current direction indication corresponds to the direction of current flow through the conductor to be measured, and clamp so that the conductor is in the center of the sensor aperture.

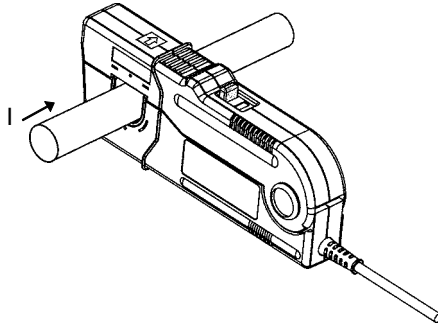

- (4) Press the slider on the sensor head until the "UNLOCK" indication disappears, and hold it until LOCK appears, and check that the opening lever is firmly locked and the clamp securely closed.
- (5) It is now possible to monitor the current waveform. The output rate of the 3274 or 3275 is 0.01 V/A. The current sensitivity can be derived from the voltage sensitivity of the waveform measurement instrument. For example, if the voltage sensitivity is 10 mV/division, the current sensitivity is 1 A/division.

**NOTE**

- When using the 3275, note that two clamp-on probes may not be used simultaneously with the 3272 POWER SUPPLY, depending on the current to be measured.
- The current consumption of clamp-on probes depends on the current to be measured. Confirm that the total current consumption of the clamp-on probes does not exceed the rated output current of the 3272. See Figure 1.

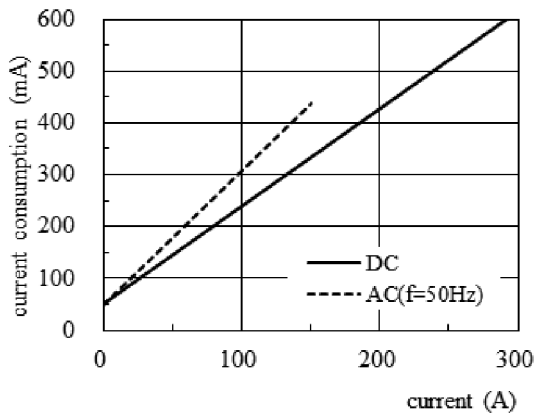
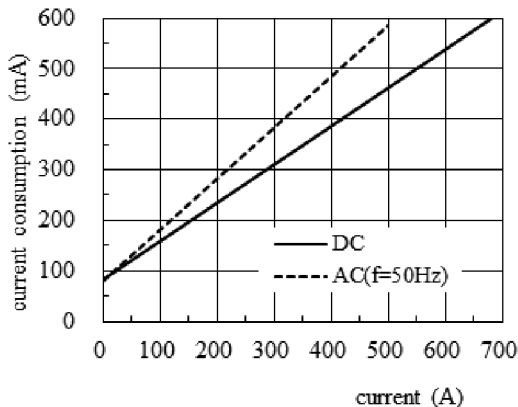

Fig.7 Current consumption\* vs. current to be measured (typical)(3274)

\*The sum total of a positive and negative current consumption



Current consumption\* vs. current to be measured (typical)(3275)

\*The sum total of a positive and negative current consumption

**CAUTION**

- The maximum continuous input range is based on heat that is internally generated during measurement. Never input current in excess of this level. Exceeding the rated level may result in damage to the probe.

- The device may sustain damage from self-heating even at current levels that are lower than the maximum current value defined by the maximum rated current.

The maximum rated current is a recommended value that assumes sine-wave input under standard conditions. Self-heating may increase if the ambient temperature increases or the measurement current waveform contains other frequency components. Refer to the derating characteristics in the product specifications.

- If excess current is input, generated heat activates a built-in safety function that blocks normal output. If this happens, remove the input immediately (remove the sensor from the conductor being measured, or reduce the input current to zero). Wait until the sensor has had sufficient time to cool before resuming operation.
- Heating generated during measurement of currents with a frequency of 1 kHz or higher is mainly attributed to the self-heating of the sensor heads. In this case, the built-in safety function will not be activated. Be careful not to have accidents including a burn by heat, short-circuit, and damage to the sensor.
- Even if the input current does not exceed the rated continuous maximum, continuous input for an extended period of time may result in activation of the safety circuit to prevent damage resulting from heating of the sensor.
- At high ambient temperatures, the built-in safety circuit may activate at current input levels below the rated continuous maximum.

**CAUTION**

- Continuous input of current exceeding the rated maximum or repeated activation of the safety function may result in damage to the device.
- The product specifications that indicate the maximum input range include a maximum peak current value in addition to the maximum rated current.  
The maximum peak current specifications are as follows:  
For Model 3274  
300 A peak (discontinuous) ..... (1)  
500 A peak (with a pulse width of 30  $\mu$ s or shorter) ..... (2)  
For Model 3275  
700 A peak (discontinuous) ..... (3)  
The values (1) and (3) determine the upper limits of the response to waveforms. Use the instrument to measure currents that do not exceed the maximum continuous input range.  
The value (2) determines the upper limit of the response to single pulse inputs. Use the instrument to measure currents that do not exceed the range described above.
- When opening the clamp, be sure to operate with the slider.
- Do not place any unclamped conductor with an electric current of a frequency of 10 kHz or more near the sensor head. Current flowing in the conductor nearby may heat up the sensor head and cause its temperature to rise, leading to damage to the sensor. For example, when one side of a go-and-return conductor is clamped and the other side is also placed near the sensor head as shown in the diagram, even if the electric current is lower than the consecutive maximum current, electric currents in both sides will heat up the wires and raise the temperature, thereby causing damage to the sensor.

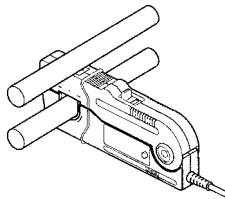

**NOTE**

- The output of this device is terminated internally. Since the output resistance is approx.7 (3274) or approx.40 (3275), the must be used with a waveform measurement instrument that has an input impedance of at least. Use a waveform measurement instrument with an input impedance of at least 1 M $\Omega$ .
- Immediately after powering on, this device may be subject to an appreciable offset drift due to the effect of self-heating. To counteract this, allow the device to warm up for about 30 minutes before carrying out measurement.
- When performing continuous measurements, it is necessary to be aware that the offset voltage drifts, depending on factors such as the ambient temperature.
- Under certain circumstances, oscillation may occur if the probe is connected to the 3269 or 3272 POWER SUPPLY while the power supply is on. This does not indicate a malfunction. Oscillation can be stopped and operation restored to normal by opening and closing the clamp.
- Depending on the amplitude and frequency of the current being measured, the sensor head may emit a resonant sound. This sound may also occur during demagnetizing operation, but it does not represent a malfunction (device failure).
- If foreign matter becomes adhered to the facing surfaces on the sensor head so that a slight gap exists between the upper and lower sensors, the sensor head may emit a resonant sound. Any foreign matter should be removed using the cleaning method described in this manual (see “ Notes on use ” (p.3 to p.8)).
- An increase in the volume of the resonant sound during use may indicate that the gap between the upper and lower sensors has increased in size. Since the sensor characteristics may change, it is recommended to calibrate the device.
- Acoustic resonance may occur depending on the level and frequency of the measured current. This does not normally affect measurements unless a foreign substance such as dust is present on the contact surfaces of the sensor head.

- Pressing the demagnetizing switch (DEMAG) will cause a demagnetized waveform to be output from the instrument. Although it may be asymmetry with respect to the zero-volt line, the instrument has no malfunction.
- The reading may be affected by the position within the clamp aperture of the conductor being measured. The conductor should be in the center of the clamp aperture.
- When carrying out measurement, press the slider on the sensor head until the "UNLOCK" indication disappears, and hold it until LOCK appears, and check that the opening lever is firmly locked and the clamp securely closed. Correct measurements cannot be performed unless the clamp is securely closed and the slider is pressed until LOCK is displayed.
- At high frequencies, common mode noise may affect measurements taken on the high voltage side of circuits. If this occurs, reduce the frequency range of the waveform measuring instrument, or clamp onto the low-voltage side of the circuit, as appropriate.

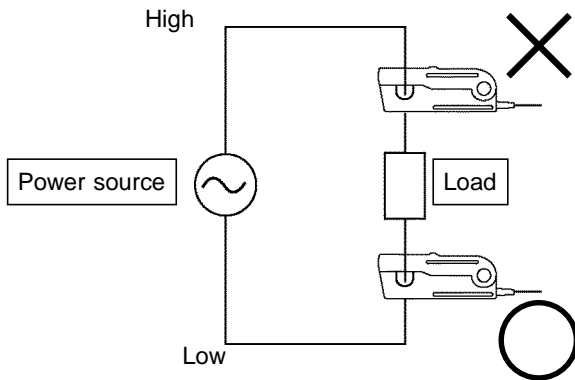

- When power is turned on, a demagnetizing waveform is initially applied to the output: this is intentional in the design, and not a fault.
- Accurate measurement may be impossible in locations subject to strong external magnetic fields, such as transformers and high-current conductors, or in locations subject to strong external electric fields, such as radio transmission equipment.





# Warranty Certificate

|   |            |   |
|---|------------|---|
| Model   | Serial No. | Warranty period<br>One (1) year from date of purchase ( __ / __ ) |
| <p>This product passed a rigorous inspection process at Hioki before being shipped.</p> <p>In the unlikely event that you experience an issue during use, please contact the distributor from which you purchased the product, which will be repaired free of charge subject to the provisions of this Warranty Certificate. This warranty is valid for a period of one (1) year from the date of purchase. If the date of purchase is unknown, the warranty is considered valid for a period of one (1) year from the product's date of manufacture. Please present this Warranty Certificate when contacting the distributor.<br/>Accuracy is guaranteed for the duration of the separately indicated guaranteed accuracy period.</p> <ol style="list-style-type: none"> <li>1. Malfunctions occurring during the warranty period under conditions of normal use in conformity with the Instruction Manual, product labeling (including stamped markings), and other precautionary information will be repaired free of charge, up to the original purchase price. Hioki reserves the right to decline to offer repair, calibration, and other services for reasons that include, but are not limited to, passage of time since the product's manufacture, discontinuation of production of parts, or unforeseen circumstances.</li> <li>2. Malfunctions that are determined by Hioki to have occurred under one or more of the following conditions are considered to be outside the scope of warranty coverage, even if the event in question occurs during the warranty period:             <ol style="list-style-type: none"> <li>a. Damage to objects under measurement or other secondary or tertiary damage caused by use of the product or its measurement results</li> <li>b. Malfunctions caused by improper handling or use of the product in a manner that does not conform with the provisions of the Instruction Manual</li> <li>c. Malfunctions or damage caused by repair, adjustment, or modification of the product by a company, organization, or individual not approved by Hioki</li> <li>d. Consumption of product parts, including as described in the Instruction Manual</li> <li>e. Malfunctions or damage caused by transport, dropping, or other handling of the product after purchase</li> <li>f. Changes in the product's appearance (scratches on its enclosure, etc.)</li> <li>g. Malfunctions or damage caused by fire, wind or flood damage, earthquakes, lightning, power supply anomalies (including voltage, frequency, etc.), war or civil disturbances, radioactive contamination, or other acts of God</li> <li>h. Damage caused by connecting the product to a network</li> <li>i. Failure to present this Warranty Certificate</li> <li>j. Failure to notify Hioki in advance if used in special embedded applications (space equipment, aviation equipment, nuclear power equipment, life-critical medical equipment or vehicle control equipment, etc.)</li> <li>k. Other malfunctions for which Hioki is not deemed to be responsible</li> </ol> </li> </ol> <p>*Requests</p> <ul style="list-style-type: none"> <li>• Hioki is not able to reissue this Warranty Certificate, so please store it carefully.</li> <li>• Please fill in the model, serial number, and date of purchase on this form.</li> </ul> |            |   |
| <b>HIOKI E.E. CORPORATION</b><br>81 Koizumi, Ueda, Nagano 386-1192, Japan<br>TEL: +81-268-28-0555<br>FAX: +81-268-28-0559   |            | 13-09   |





- Please visit our website at [www.hioki.com](http://www.hioki.com) for the following:
  - Regional contact information
  - The latest revisions of instruction manuals and manuals in other languages.
  - Declarations of Conformity for instruments that comply with CE mark requirements.
- All reasonable care has been taken in the production of this manual, but if you find any points which are unclear or in error, please contact your supplier or the International Sales and Marketing Department at Hioki headquarters.
- In the interests of product development, the contents of this manual are subject to revision without prior notice.
- The content of this manual is protected by copyright.  
No reproduction, duplication or modification of the content is permitted without the authorization of Hioki E.E. Corporation.

# HIOKI

---

HIOKI E. E. CORPORATION

## HEADQUARTERS

81 Koizumi, Ueda, Nagano 386-1192, Japan  
TEL +81-268-28-0562 FAX +81-268-28-0568  
[os-com@hioki.co.jp](mailto:os-com@hioki.co.jp)  
(International Sales Department)

## [www.hioki.com](http://www.hioki.com)

## HIOKI USA CORPORATION

[hioki@hiokiusa.com](mailto:hioki@hiokiusa.com)    [www.hiokiusa.com](http://www.hiokiusa.com)

## HIOKI (Shanghai) SALES & TRADING CO., LTD.

[info@hioki.com.cn](mailto:info@hioki.com.cn)    [www.hioki.cn](http://www.hioki.cn)

## HIOKI INDIA PRIVATE LIMITED

[hioki@hioki.in](mailto:hioki@hioki.in)    [www.hioki.in](http://www.hioki.in)

## HIOKI SINGAPORE PTE. LTD.

[info@hioki.com.sg](mailto:info@hioki.com.sg)

1502EN